

Traffic Signs Manual

CHAPTER 3

Regulatory Signs
2008



Published by TSO (The Stationery Office) and available from:

Online

www.tsoshop.co.uk

Mail, telephone, fax and email

TSO, PO Box 29, Norwich, NR3 1GN

Telephone orders/general enquiries: 0870 600 5522

Order through the Parliamentary Hotline Lo-Call: 0845 702 3474

Fax orders: 0870 600 5533

Email: customer.services@tso.co.uk

Textphone: 0870 240 3701

TSO shops

16 Arthur Street, Belfast BT1 4GD

Tel: 028 9023 8451 Fax: 028 9023 5401

71 Lothian Road, Edinburgh EH3 9AZ

Tel: 0870 606 5566 Fax: 0870 606 5588

The Parliamentary Bookshop

12 Bridge Street, Parliament Square, London SW1A 2JX

TSO@Blackwell and other accredited agents

Traffic Signs Manual

Chapter 3

Regulatory Signs

Department for Transport

Department for Regional Development (Northern Ireland)

Scottish Executive

Welsh Assembly Government

Contents of Chapters 1-8

- CHAPTER 1** Introduction
- CHAPTER 2** Directional Informatory Signs on Motorways and All-Purpose Roads *
- CHAPTER 3** Regulatory Signs
- CHAPTER 4** Warning Signs
- CHAPTER 5** Road Markings
- CHAPTER 6** Illumination of Traffic Signs *
- CHAPTER 7** The Design of Traffic Signs
- CHAPTER 8** Traffic Safety Measures and Signs for Road Works and Temporary Situations

* To be published

Published for the Department for Transport under licence from
the Controller of Her Majesty's Stationery Office

© Crown copyright, 2008

Copyright in the typographical arrangement rests with the Crown.

This publication, excluding logos, may be reproduced free of charge in any format or medium for non-commercial research, private study or for internal circulation within an organisation. This is subject to it being reproduced accurately and not used in a misleading context. The copyright source of the material must be acknowledged and the title of the publication specified.

For any other use of this material, apply for a Click-Use Licence at www.opsi.gov.uk/click-use/index.htm, or by writing to the Information Policy Team, Office of Public Sector Information, Kew, Richmond, Surrey TW9 4DU or e-mail licensing@opsi.x.gsi.gov.uk.

This is a value added publication which falls outside the scope of the Public Sector Information Click-Use Licence.

ISBN 978 0 11 552925 2

This edition first published 2008.
Second impression 2008.

Printed in Great Britain on paper containing at least 75% recycled fibre.

Traffic Signs Manual

Chapter 3

CONTENTS

1. INTRODUCTION	5
2. LEGAL	9
3. STOP AND GIVE WAY SIGNS	11
4. COMPULSORY AND PROHIBITED MOVEMENTS	16
5. PROHIBITION OF TRAFFIC	30
6. PROHIBITION OF WAITING AND LOADING	42
7. ON-STREET PARKING AND LOADING	54
8. VERGE OR FOOTWAY PARKING	70
9. CLEARWAY AND NO STOPPING SIGNS	76
10. RED ROUTES	83
11. PEDESTRIAN ZONES	88
12. CONTROLLED PARKING ZONES	96
13. RESTRICTED PARKING ZONES	102
14. SPEED LIMITS	105
15. BUS LANES AND GATES	130

16. TRAM SIGNS	142
17. CYCLE FACILITIES	146
18. LANE CONTROL SIGNALS AND SIGNS FOR TIDAL FLOW	156
APPENDIX A: Sizes of signs	160
APPENDIX B: Variation of numerals as prescribed by Schedule 16 to the Regulations	167
APPENDIX C: Schedule 19 (Part I) to the Regulations: Significance of bus stop and bus stand clearway markings	168
APPENDIX D: Northern Ireland variations	169
APPENDIX E: Index of diagram numbers	173
INDEX	176

1 INTRODUCTION

GENERAL

1.1 The Traffic Signs Manual is intended to give advice to traffic authorities and their agents on the correct use of signs and road markings. Mandatory requirements are set out in the current version of the Traffic Signs Regulations and General Directions; nothing in the Manual can override these. The advice is given to assist authorities in the discharge of their duties under section 122 of the Road Traffic Regulation Act 1984 and Part 2 of the Traffic Management Act 2004. Subject always to compliance with the Directions, which, except in Northern Ireland, are mandatory (see para 1.4), it is for traffic authorities to determine what signing is necessary to meet those duties, although failure to follow the Manual's guidance without good reason might well lead to enforcement difficulties. In particular, adjudicators might consider such failure to be evidence that the signing was unclear. Traffic authorities should always remember that the purpose of regulatory signs is to ensure that drivers clearly understand what restrictions or prohibitions are in force.

1.2 The Traffic Signs Manual is applicable in England, Northern Ireland, Scotland and Wales. References to the "Secretary of State" should therefore be interpreted as referring to the Secretary of State for Transport, the Department for Regional Development (Northern Ireland), the Scottish Executive or the Welsh Assembly Government as appropriate. Any reference to the "Department" is a reference to the Department for Transport or the appropriate national office for Northern Ireland, Scotland or Wales as described above.

1.3 Any reference to a "Chapter" is a reference to a Chapter of the Traffic Signs Manual, and any reference to a "section", unless otherwise stated, is a reference to a section in this chapter of the Manual. Where more detailed background information might be helpful, reference is made to Departmental Standards and Advice Notes. These can be found in the Design Manual for Roads and Bridges, published by the Stationery Office.

1.4 Any reference to the "Regulations" or the "Directions" is a reference to the Traffic Signs Regulations and General Directions 2002 (as amended), applicable to England, Scotland and Wales. Reference to a diagram number or to a Schedule is a reference to a diagram or schedule in

those Regulations. In Northern Ireland the relevant legislation is the Traffic Signs Regulations (Northern Ireland) 1997. Diagram and regulation numbering occasionally differs in these Regulations (see Appendix D) and there are no General Directions. Sign layouts, meanings and permitted variants are generally similar but can vary; where the NI Regulations apply, the designer is advised to read them in conjunction with the Manual. Not all signs referred to in the text are included in the NI Regulations. References to directions are not applicable in Northern Ireland; where these are referred to, advice should be sought from the Department for Regional Development's Roads Service Headquarters. Appendix D also lists the appropriate legislation applicable in Northern Ireland where this varies from that in England.

1.5 In this chapter the word "must" is used to indicate a legal requirement of the Traffic Signs Regulations and General Directions that must be complied with. The word "shall" indicates an essential (or mandatory) requirement of compliance with this chapter, and "should" indicates a course of action that is strongly recommended and represents good practice. The word "may" generally indicates a permissible action, or an option which requires consideration depending on the circumstances.

TYPES OF REGULATORY SIGN

1.6 Regulatory signs indicate requirements, restrictions and prohibitions. Most are erected to give effect to a traffic regulation order or other statutory provision (see para 2.2). There are certain signs where the legal requirements are specified in the Regulations; these include STOP, GIVE WAY, Keep Left and mini-roundabout signs.

1.7 Regulatory signs either give positive instructions or indicate a prohibition. Positive signs are generally circular with a white border and symbol on a blue background. They usually indicate something all drivers must do (e.g. keep left) or a facility available to certain classes of traffic (e.g. buses only). The exceptions are the octagonal red STOP sign and the triangular GIVE WAY sign. Prohibitory signs, which generally tell drivers what they must not do, are mostly circular and have a red border. The red ring indicates the prohibition; diagonal bars are used only on signs which prohibit a specific manoeuvre, i.e. banned left or right turns or U-turns. Other regulatory

signs give details of waiting and loading restrictions and the use of on-street parking places. These signs are rectangular and generally mounted parallel to the edge of the carriageway.

1.8 Many regulatory signs are accompanied by supplementary plates. There are restrictions on which plates may be used with individual signs; the plates prescribed for use with each sign are indicated below each diagram illustrated in this chapter. Detailed drawings showing the correct layouts for most permitted variants have been produced by the Department for Transport (see para 1.9).

1.9 Precise dimensions for all diagrams are indicated in the “P” series of working drawings, available free of charge on the Department for Transport’s website. These also specify the permitted variants of symbols, and show the correct layout of supplementary plates not illustrated in the Regulations. The “S” series of working drawings provides details of the more complex symbols and pictograms.

1.10 Signs to give advance warning of regulatory restrictions are sometimes needed; most of these are dealt with in Chapter 4, e.g. STOP and GIVE WAY ahead (diagrams 501, 502 and 503) and mandatory height restriction (diagrams 818.3 and 818.4).

1.11 Some regulatory signs are accompanied by road markings; details of these are in Chapter 5.

1.12 Certain regulatory signs may be incorporated into directional signs to give advance warning of a restriction (see para 5.3); for design details see Chapter 7. Such additional guidance is purely informative; the normal regulatory signs must still be provided to make the restriction enforceable.

1.13 Guidance on the use of regulatory signs at road works and temporary situations is given in Chapter 8.

SIGN SIZES

1.14 It is important that signs giving effect to traffic regulation orders, and intended to be read from a moving vehicle, are of sufficient size to enable drivers to recognise them and assimilate the information in time. They therefore need to be of a size appropriate to the prevailing traffic speed on the road on which they are used (see Appendix A). All sign sizes, generally based on the 85th percentile approach speed, are in millimetres unless stated otherwise.

SITING

1.15 It is essential that drivers have an unobstructed view of traffic signs. The distance which should be kept clear of obstructions to the sight line, whether caused by vegetation, other signs or street furniture, is known as the clear visibility distance. The higher the prevailing traffic speeds, the greater this distance needs to be.

Table 1-1 Minimum clear visibility distances

85th percentile speed of private cars (mph)	Minimum clear visibility distance (metres)
Up to 20	45
21 to 30	60
31 to 40	60
41 to 50	75
51 to 60	90
Over 60	105 (120)

1.16 Table 1-1 specifies minimum clear visibility distances. These should normally be measured from the centre of the most disadvantaged driving lane. It is important that the full recommended sight line to the whole of the sign face is preserved. Cutting back of vegetation only in the immediate vicinity of the sign might not be sufficient; sign visibility should always be checked from the appropriate viewing distance.

1.17 The bracketed visibility distance of 120 m in table 1-1 is generally for dual carriageway roads and motorways with a 70 mph speed limit, where the bracketed larger size of sign in Appendix A is used.

1.18 Table 1-1 does not apply to speed limit and speed camera signs (see section 14), signs to diagrams 958 and 958.1 (see paras 15.9 and 17.5 respectively), or to time plates that are parallel to the kerb.

1.19 Regulatory signs that indicate the beginning of a restriction or prohibition and to which direction 8 applies have to be placed in accordance with that direction. The requirement is that the signs must be placed on each side of the road or on each side of the appropriate carriageway of a dual carriageway road, except that signs need only be placed on one side if any of the following circumstances apply:

- (i) where the restriction, requirement or prohibition applies only to one side of the road.
- (ii) at a junction where traffic turns from a one-way road into the relevant road. The sign should be angled to face towards the driver.
- (iii) at a junction where the carriageway of the relevant road is less than 5 m wide and the centre of the sign is no more than 2 m from the edge of the carriageway.

Both directions 8 and 9 also apply to signs indicating the beginning of a speed limit, see section 14. Guidance on siting other regulatory signs such as diagram 606 (direction in which traffic must proceed), diagram 612 (no right turn) and signs indicating waiting restrictions, can be found in the relevant sections of this chapter.

1.20 Signs giving effect to No Stopping orders (see section 9) should, whenever possible, be mounted to face traffic. A driver does not then have to stop to read the sign, possibly resulting in an offence.

MOUNTING

1.21 The normal mounting height measured to the lower edge of a sign or backing board (or any supplementary plate) is between 900 mm and 1500 mm above the carriageway alongside. The greater height should be used where vehicle spray is likely to soil the sign, or above planted areas. Careful consideration should be given to any proposal to mount signs at a low height, such as on railings or bollards, as there is a risk of drivers not noticing them, especially at night or when they could be obscured by parked vehicles or pedestrians. Where signs are erected above footways, or in areas likely or intended to be used by pedestrians (e.g. pedestrian refuges), a headroom of 2300 mm is recommended, with 2100 mm as an absolute minimum. A clearance of at least 2300 mm should be maintained over a cycle track or shared cycleway/footway.

1.22 Supplementary plates should be separated from the sign or another plate by a vertical space not exceeding the x-height of the legend, and ideally half the x-height (but see para 1.28). When mounted on a backing board (see paras 1.31 to 1.33), this space should be 0.05 times the roundel diameter.

1.23 Except where they support a luminaire, posts should never project above the top of the sign (see clause 1204 in the Specification for Highway Works, Series 1200, Traffic Signs). This practice is unsightly, and needlessly increases visual intrusion and clutter.

1.24 Where posts are erected on footways, there should be an absolute minimum of 1000 mm of unobstructed width to allow the passage of wheelchairs. Posts not readily visible to pedestrians or cyclists may be provided with a yellow or white band in accordance with the requirements of direction 41(2).

MOUNTING MORE THAN ONE SIGN ON A POST

1.25 Research has shown that the greater the number of signs which drivers are presented with simultaneously, the greater the difficulty they are likely to have in assimilating the information. This problem in dealing with information overload increases with age, so that older drivers suffer disproportionately. Generally, therefore, not more than two signs should be erected on any one post when intended to be read from an approaching vehicle. This also applies to signs mounted at the same location on separate posts. Where a sign requires a supplementary plate, the combination of sign and plate may be regarded as one sign. Exceptionally, three signs may be mounted on one post, or at the same location, provided none requires a supplementary plate.

1.26 STOP or GIVE WAY signs or signs indicating the start of a speed limit (terminal signs) should not be mounted on the same post as a warning sign. Speed limit terminal signs should wherever possible be mounted alone. For further guidance on mounting speed limit signs, including repeater signs, see paras 14.60 to 14.62. Sign combinations, excluding speed limit terminal signs, which may be mounted together should be placed in the following order from top to bottom:

- (i) STOP or GIVE WAY or any triangular warning sign
- (ii) speed limit repeater signs
- (iii) other circular signs
- (iv) rectangular signs.

1.27 All proposed assemblies should be critically examined to ensure that the intended messages are clear. Ambiguity may result in difficulty enforcing a traffic regulation order. Where a supplementary plate with the legend “End” (diagram 645) is used to indicate the termination of a prohibition or restriction, particular care is necessary to ensure that it is clear which sign it applies to when there is more than one.

1.28 Where a speed limit sign is erected on the same post as a clearway sign accompanied by an “End” plate, the plate should be butted directly up to the lower edge of the clearway sign. The speed limit sign should be mounted at the top of the assembly with a space equal to twice the width of the red border between the roundels to ensure there is no ambiguity.

1.29 Generally no assembly should exceed 4 m in height above ground level. This may be exceeded to improve visibility of the signs at particularly difficult sites, but account should always be taken of the potential environmental impact of tall and cluttered sign assemblies.

1.30 It should also be borne in mind that high-mounted signs may receive little light from car headlamps, particularly on dipped beam. Where such signs are not directly lit but rely on reflectorisation to be seen at night, they are likely to be less conspicuous and less legible.

BACKING BOARDS

1.31 To improve conspicuity against a complex or dark background, a regulatory sign may be mounted on a grey or yellow backing board (direction 42, as amended by the Traffic Signs (Amendment) General Directions 2004). A backing board can also make for a neater assembly, e.g. when a sign requires a supplementary plate, and also eliminates the risk of the plate becoming misaligned. A yellow backing board must be rectangular in shape (except when a speed limit terminal sign is mounted with a town or village boundary sign; see para 14.51), but a grey board may be non-rectangular, e.g. to enable a circular sign to be bracketed off a lamp column. A backing board must not itself be provided with a border, nor give the impression of being an

additional border. Where it seems that a sign is not being noticed by drivers, it should be checked to ensure that it is well-sited, not obscured by vegetation or other obstructions, and is of the appropriate size and in good condition. Only then should the use of a yellow backing board be considered.

1.32 A yellow backing board may be reflectorised to increase its conspicuity at night, although this is not usually necessary for regulatory signs. In most cases these are lit when placed on lit roads, or are mounted parallel to the kerb, and on unlit roads reflectorisation of the sign is usually sufficient to ensure night-time conspicuity. A yellow backing board may also be fluorescent; this greatly increases conspicuity in dull weather and at dusk. Fluorescence can also be particularly effective in drawing attention to signs mounted in deep shadow, e.g. below overhanging trees. However, fluorescence is visually intrusive and should be used with discretion. The modern true yellow materials are less garish than the original yellow-green type and are much to be preferred.

1.33 There are potential disadvantages to the use of backing boards. The larger overall size of the assembly can sometimes obstruct sight lines. A backing board can deprive non-rectangular signs of a primary recognition aid: their distinctive silhouette. Yellow backing boards can be especially environmentally intrusive, and their over-use could eventually devalue their attention-attracting benefits. A less garish way of increasing a sign’s conspicuity is simply to provide a standard sign of larger size. Not only will this be more noticeable than a smaller sign, but it will also improve legibility and hence reading distance, which a yellow backing board cannot. Detailed guidance on the correct design and use of backing boards can be found in Chapter 7 (paras 14.19 to 14.24). Guidance on the use of backing boards for speed limit signs is given in this chapter (paras 14.50 to 14.53).

ILLUMINATION

1.34 For general guidance on sign illumination see paras 2.5 to 2.7. For illumination of speed limit signs see paras 14.54 to 14.58.

GENERAL

2.1 All traffic signs placed on a highway or on a road to which the public has access (right of passage in Scotland), as defined in section 142 of the Road Traffic Regulation Act 1984 and amended by the New Roads and Street Works Act 1991, must be either prescribed by Regulations or authorised by the Secretary of State for Transport (for installations in England), the Department for Regional Development (Northern Ireland), the Scottish Executive or the Welsh Assembly Government as appropriate. Care should be taken to ensure that signs are used only as prescribed in the Regulations, and in accordance with any relevant directions, and that no non-prescribed sign is used unless it has been formally authorised in writing. Failure to do so may leave an authority open to litigation, or make a traffic regulation order unenforceable. There could be circumstances where it might be appropriate to use prescribed signs in a manner that is not strictly in accordance with the Directions. In such cases, a special direction (not an authorisation), given in writing, should be sought from the Department. Except in the case of certain signs to indicate temporary obstructions or placed by the police in an emergency, signs may be placed only by or with the permission of the traffic authority.

2.2 Most regulatory signs are the means of putting into practical effect an Act, order, regulation, byelaw or notice (direction 7). For example, such orders may impose restrictions on speed, on the turning of traffic in a particular direction at a junction, or on waiting. Most regulatory signs are therefore used to give effect to a traffic regulation order. Restrictions, and the supporting traffic orders, particularly those for parking controls, should be kept as simple as possible in order to avoid complex traffic signs that might be difficult for drivers to understand.

2.3 Where an order is not required, this is indicated in the relevant section of this chapter. Even signs which do not require an order may, by virtue of regulation 10, be subject to section 36 of the Road Traffic Act 1988; these are listed below:

- 601.1 (but does require the Secretary of State's approval, see direction 6)
- 602
- 606 when used on the central island of a roundabout or at a junction with a dual carriageway road
- 609 when used on the approach to a dual carriageway road

- 610
- 611.1
- 615
- 616 in certain circumstances (see para 4.44)
- 629.2 and 629.2A where used on a road where headroom is limited by a structure (see para 5.42).

Although a bus stop clearway does not require an order, and the signs to diagrams 974 and 975 are not included in regulation 10, the road markings to diagrams 1025.1, 1025.3 and 1025.4 are, and are therefore subject to section 36 of the Road Traffic Act 1988. However, they must be accompanied by a sign to diagram 974 or 975 (direction 25(1)).

2.4 In this chapter, the words "exception" and "excepted" are used to describe variations to an order that need to be signed, and "exempt" and "exempted" to indicate those that do not.

ILLUMINATION

2.5 Illumination requirements for traffic signs are set out in Schedule 17 and referenced as Item 5 in the tables associated with each diagram. Most regulatory signs, other than those that prohibit waiting and loading, or indicate parking places, must be lit in accordance with Schedule 17 Item 1. This requires signs to be directly lit if they are sited within 50m of a street lamp forming part of a system of street lighting. However, certain exceptions are permitted in paragraph (4) in column (3) of Item 1. These include the "one-way traffic" sign shown in diagram 652 (see paras 4.35 to 4.37) when sited more than 50m from a junction, signs placed to indicate the provision of a temporary order, and road works signs on a road where the permanent speed limit is 40mph or less. Signs that qualify for this exemption from direct lighting, and those listed in Schedule 17 Item 1 that are located on unlit roads, need only be reflectorised (see para 2.6), although they may be directly lit. Schedule 17 Items 6 and 7 deal with signs mounted on traffic signals and in illuminated bollards respectively. See paras 14.54 to 14.58 for the illumination of speed limit signs.

2.6 Signs listed in Schedule 17 Item 4, such as those for bus lanes, must be either directly lit or reflectorised in accordance with regulation 19, whether or not the road is lit. It is not, therefore, a regulatory requirement to directly light these signs within a system of street lighting. However, some

signs may be sited where they will not receive adequate illumination from headlamps, and it might be prudent to provide direct lighting regardless of the regulatory requirements. Examples include signs mounted unusually high above the level of the carriageway, on the off side of the road or at the entrance to a side road. Retroreflection is also less effective where the sign is presented at a large angle to the direction of oncoming traffic. Modern microprismatic materials can achieve high luminances for many drivers in defined situations, but not for all drivers in all circumstances. However, some are

designed to produce luminances little better than that of traditional beaded materials. Where regulatory signs on lit roads are exempted from the requirement to be directly lit, high-performance microprismatic sheetings (achieving a minimum performance index of 3.0 when rated in accordance with BS 8408:2005) are recommended.

2.7 Some regulatory signs, including time plates indicating parking controls and those intended for pedestrians, need not be directly illuminated or reflectorised. These are listed in Schedule 17 Item 9.

3 STOP AND GIVE WAY SIGNS

GENERAL

3.1 The STOP sign to diagram 601.1 and the GIVE WAY sign to diagram 602 impose mandatory requirements on drivers entering a major road or crossing a railway or tramway. When the signs are to be installed in conjunction with railway level crossings or tramway crossings, the railway or tramway infrastructure manager and Her Majesty's Railway Inspectorate (a directorate of the Office of Rail Regulation) should be consulted beforehand.

3.2 STOP and GIVE WAY signs are subject to section 36 of the Road Traffic Act 1988 (see regulation 10). Where a driver fails to comply, the offence is one of failing to obey a traffic sign, not failing to comply with a traffic regulation order. Orders are not therefore required to install these signs. However, STOP signs may be erected only at sites approved in writing by the Secretary of State (direction 6).

3.3 It is expected that most junctions that would satisfy the criteria for STOP signs have already been approved. New junctions should not be constructed with very poor visibility, so new approvals for STOP signs should be exceptional.

3.4 The Directions prohibit the use of STOP or GIVE WAY signs on all approaches to a junction, as this would cause uncertainty as to which vehicles had priority.

3.5 Advance warning of the requirement to stop or give way may be given using the sign to diagram 501 together with the plate to diagram 502 or 503 as appropriate (see Chapter 4, para 2.1).

3.6 The plate to diagram 608 (Dual carriageway) may be mounted below the STOP or GIVE WAY sign on the minor road approaching a dual carriageway where there is a gap in the central reservation. This warns drivers from the minor road that, if turning right, they should turn after the central reservation.

STOP SIGNS

3.7 Where a STOP sign (diagram 601.1) has been provided, regulation 16 requires that:

- (i) every vehicle shall stop before crossing the transverse line shown in diagram 1002.1; and

- (ii) no vehicle shall cross that line so as to be likely to endanger the driver of or any passenger in any other vehicle or to cause that driver to change the speed or course of his vehicle in order to avoid an accident.

Similar requirements apply at railway and tramway crossings where a STOP sign has been provided (see paras 3.18 and 3.20).

3.8 STOP signs, other than at junctions with tramways, will be approved only where visibility is so restricted that it is essential for drivers to stop before entering the major road. The sign will be well respected only if drivers can see the need for it. The possibility of making a visibility improvement at a junction should always be investigated before considering a STOP sign. Restriction of visibility caused, for example, by a hedge that can be reduced in height or removed will not normally justify a STOP sign, particularly as highway authorities have powers under section 79 of the Highways Act 1980 to remove obstructions to visibility at junctions.

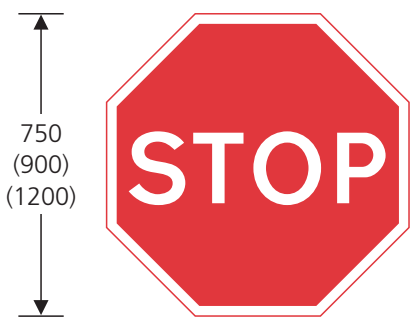

601.1 Junction controlled by a STOP sign

May be used only in conjunction with the markings to diagrams 1002.1 and 1022, and may be used with diagram 608 or 783



608 Dual carriageway

3.9 Visibility distances below which a STOP sign might be considered are specified in table 3-1. Other factors which should be taken into account include traffic volumes on both the major and minor roads, gradient of the minor road, accident record, poor alignment or any other factors which cause unusual difficulty. It does not automatically follow that STOP signs will always be approved at sites where the criteria are met. If any changes take place at a junction that already has a STOP sign, it will be necessary to check if the criteria are still met, and if not the junction should be assessed for the appropriate level of signing (see para 3.13).

Table 3-1 Visibility criteria for STOP sign

85th percentile speed of private cars on major road (mph)	Visibility distance along major road (m)
20	15
30	30
40	45
50	70
60	90
70	120

3.10 The visibility distance in table 3-1 is measured along the nearer edge of the major road from a point 1.05 m above the centre line of the minor road (representing the driver's eye position). The distances in the table should be interpolated for intermediate speeds (e.g. 37.5 m for a speed of 35 mph). Where the minor road is lightly trafficked, this visibility should be available from a point 3 m back from the edge of the major road carriageway along the centre line of the minor road. This distance should be increased to 4.5 m where the minor road has some through-traffic value. Visibility from the side road along the major road is important to the left as well as to the right, especially where there is the likelihood of vehicles from the left overtaking or the major road is one way from left to right.

3.11 The appropriate size for the STOP sign is indicated in table 3-2. The smaller sizes shown in brackets may be used where an advance warning sign is provided (see para 3.5). The 85th percentile speed should be measured at a point prior to traffic slowing down for the junction.

Table 3-2 Size of STOP sign

85th percentile speed of private cars approaching on minor road (mph)	Size of STOP sign (mm)
Up to 30	750
31 to 40	900 (750)
41 to 50	1200 (900)
Over 50	1200

GIVE WAY SIGNS

3.12 Where there is a GIVE WAY sign (diagram 602), regulation 16 requires that:

No vehicle shall cross the transverse line shown in diagram 1003 nearer to the major road at the side of which that line is placed, or if that line is not clearly visible, enter that major road, so as to be likely to endanger the driver of or any passenger in any other vehicle or to cause that driver to change the speed or course of his vehicle in order to avoid an accident.

When the sign is used in combination with diagram 778 or 778.1 (see paras 3.19 and 3.20), the requirement is for vehicles to give way to railway vehicles or tramcars.

3.13 The GIVE WAY sign, together with its associated road markings (see para 3.15), should be used as follows:

- (i) in rural areas at all junctions of public roads with trunk and principal roads
- (ii) in urban areas generally at junctions of public roads with trunk and principal roads unless the minor road is a residential or local street
- (iii) at other junctions where the traffic authority considers it desirable on account of traffic speeds or volumes
- (iv) at rural crossroads where both roads are minor in nature and visibility of the junction is poor (e.g. hidden dip, blind summit, obscured by hedges, narrow verges etc.)

- (v) exceptionally at roundabouts where there is a signalled crossing on the immediate approach and the associated green aspect might give the impression that a vehicle has precedence entering the roundabout
- (vi) exceptionally at roundabouts where the normal give way rule is reversed (see para 3.17)
- (vii) in exceptional cases at mini-roundabouts where it is not possible to provide deflection (see para 4.23)
- (viii) with the "Dual carriageway" plate to diagram 608 on the approach to a dual carriageway road with a gap in the central reservation (see para 3.6).

The use of a GIVE WAY sign should also be considered at the following locations:

- (ix) non-signalled approaches to a partially-signalled roundabout or gyratory system
- (x) where the priority route through the junction is not clear (e.g. priority route turns right or left at the junction)
- (xi) at the end of an unsignalled left turn filter lane at a signalled junction.

Where a sign to diagram 602 is not justified, carriageway markings alone should be provided in accordance with Chapter 5 para 3.14. The sign is not used in conjunction with priority signs (see para 4.33).



602 Junction controlled by a GIVE WAY sign

May be used only in conjunction with the markings to diagrams 1003 and 1023 and may be used with diagram 608, 611.1, 774, 778 or 778.1

Table 3-3 Size of GIVE WAY sign

85th percentile speed of private cars approaching on minor road (mph)	Size of GIVE WAY sign (mm)
Up to 30	600
31 to 40	750 (600)
41 to 50	900 (750)
51 to 60	1200 (900)
Over 60	1200 (1500)

3.14 The appropriate size for the GIVE WAY sign is indicated in table 3-3. The smaller sizes shown in brackets may be used where an advance warning sign is provided (see para 3.5). The larger size for approach speeds over 60mph might be helpful where there is a history of failure to give way accidents. The 85th percentile speed should be measured at a point prior to traffic slowing down for the junction.

ROAD MARKINGS

3.15 The STOP and GIVE WAY signs must always be accompanied by their associated road markings (diagrams 1002.1 and 1022, and 1003 and 1023 respectively). These markings are detailed in Chapter 5 (paras 3.11 to 3.23 and figures 3-1 and 3-2). Reference should be made to Chapter 8 for guidance on the use of warning signs when road works result in the temporary absence of markings.

SITING OF STOP AND GIVE WAY SIGNS

3.16 The signs should be sited as close as possible to their corresponding marking, but not in such a position as to impair visibility along the major road. Normally they will be about 1.5 m before the marking (see figure 3-1). If conditions prevent a sign from being easily seen, it should be placed at a greater distance. The STOP sign should be no more than 6m from the line, and the GIVE WAY sign no more than 12 m.

3.17 The signs should be sited on the left hand side of the road. For greater emphasis, they may be duplicated on the right hand side. This should be standard practice on wide one-way roads. If there is

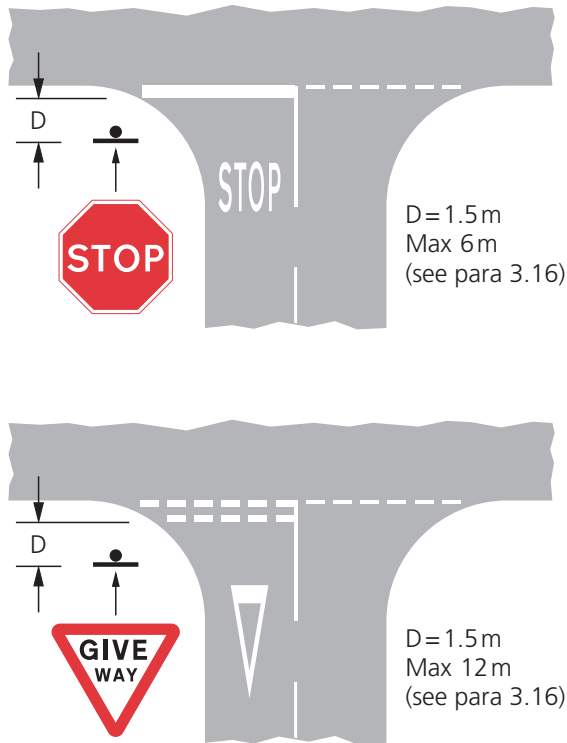

Figure 3-1 Siting of STOP and GIVE WAY signs

a refuge in the mouth of the minor road and there are two or more lanes at the Stop or Give Way line, consideration should be given to duplicating the sign on the refuge. The GIVE WAY sign should be duplicated at roundabouts where drivers are required to give way to traffic entering the junction (see Chapter 5, figure 8-6).

RAILWAY AND TRAMWAY CROSSINGS

3.18 STOP signs are placed at user-worked railway level crossings; these are normally crossings involving public footways or bridleways, or private roads. In these circumstances, the STOP sign is used in combination with the supplementary plate to diagram 783 (“DRIVERS OF LONG LOW VEHICLES phone before crossing” or its “LARGE OR SLOW” variant).

3.19 At open railway level crossings and tramway crossings (i.e. those with no barriers and without signals) the GIVE WAY sign is used in combination with diagrams 774 and 778 or 774 and 778.1 as appropriate. Diagram 774 is mounted uppermost, with the plate to diagram 778 or 778.1 below diagram 602.



783 Drivers of long low vehicles phone before crossing

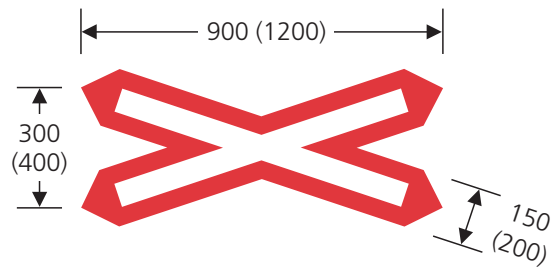

774 Location of railway or tramway crossing without gate or barrier

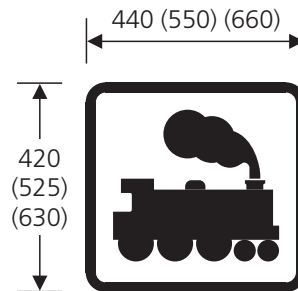

778 Open railway level crossing without light signals

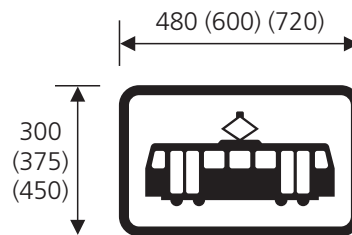

778.1 Open tramway crossing without light signals

3.20 At priority junctions, roads that have tramways, either segregated or within the carriageway, should always be treated as the major road. Where the minor road would normally be provided with an upright GIVE WAY sign as well as the Give Way road markings (see para 3.15), this should be replaced with a STOP sign and transverse Stop line, whether or not the visibility criteria in table 3-1 are met. The STOP sign should be used with a supplementary plate to diagram 778.1. This will require a special direction in addition to the Department's approval for the

STOP sign, as this sign combination is not prescribed by the Regulations. At all other junctions with a road carrying a tramway, the minor road should have the transverse Give Way line, the triangular marking and a GIVE WAY sign.

3.21 Junctions with heavy traffic flows or restricted visibility (including those which would normally be signed with the STOP sign) should be controlled by traffic signals where there is a tramway.

4 COMPULSORY AND PROHIBITED MOVEMENTS

GENERAL

4.1 The signs in this section generally give instructions regarding manoeuvres that must or must not be made. Positive signs tell drivers what must be done; prohibitory signs indicate a forbidden manoeuvre. They cover both junctions and the sections of road between junctions.

LIMITED MOVEMENTS THROUGH JUNCTIONS

4.2 The sign to diagram 606 is used to indicate the only route that may lawfully be taken through a junction. It may point horizontally to the left or to the right, or vertically upwards. The sign to diagram 609 is an advance sign indicating a compulsory left or right turn. The signs to diagrams 612 and 613 indicate "no right turn" and "no left turn" respectively. The choice of sign or signs for a particular junction will depend on the road layout, the permitted movements and whether there are traffic signals. The following paragraphs and figures 4-1 to 4-8 cover various situations. See

paras 4.16 to 4.18 for the siting of these signs and 4.14 and 4.15 for the use of supplementary plates to indicate exceptions.

4.3 At an unsignalled junction where a side road forms a T-junction with a one-way road (see figure 4-1) and traffic is required to turn in one direction only from the side road, a sign to diagram 606 with a supplementary plate to diagram 607 (One way) should be used. These signs are placed opposite the side road. The advance sign to diagram 609 may be used in the minor road, together with the "One way" plate. Where the main road is a dual carriageway without a gap in the central reservation (see figure 4-2) a traffic regulation order is not required (see direction 7(3)). A sign to diagram 606 pointing to the left is used with a supplementary plate to diagram 608 (Dual carriageway). These signs are placed on the central reservation opposite the side road. Again, the advance sign to diagram 609 may be used, this time with the "Dual carriageway" plate. Where the dual carriageway has a gap in the central reservation and the right turn is prohibited, "no entry" signs to diagram 616 should be erected on each side of the

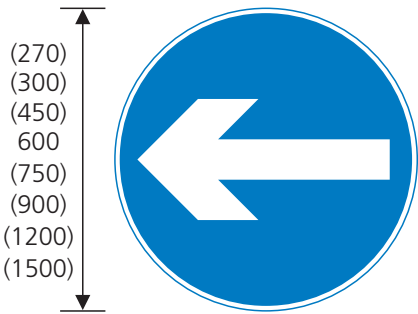

606 Vehicular traffic must proceed in the direction indicated by the arrow

May be used with diagram 515, 515.1A, 515.2, 607, 608, 954, 954.2, 954.3, 954.4, 954.5, 954.6 or 954.7. The arrow may point to the left, right or straight ahead

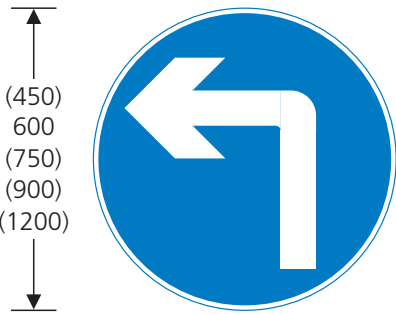

609 Vehicular traffic must turn ahead in the direction indicated by the arrow

May be used with diagram 607, 608, 954, 954.2, 954.3 or 954.4. The arrow may point to the right



607 One way traffic

May be used only in combination with diagram 606 or 609



608 Dual carriageway

May be used only in combination with diagram 501, 601.1, 602, 606, 609 or 610

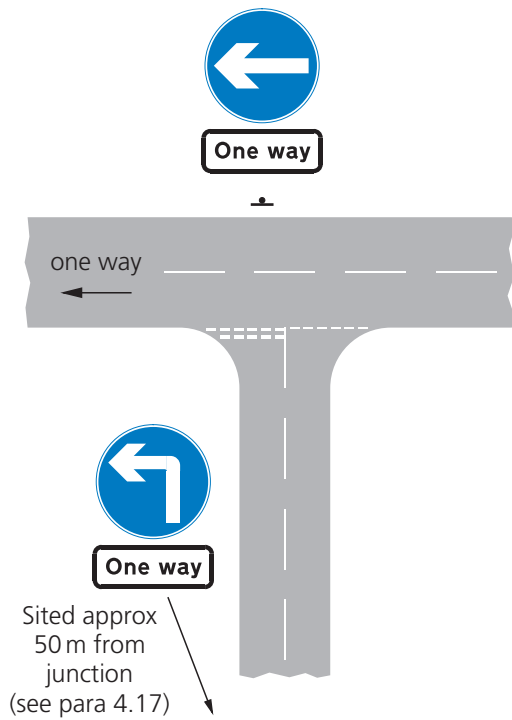

Figure 4-1

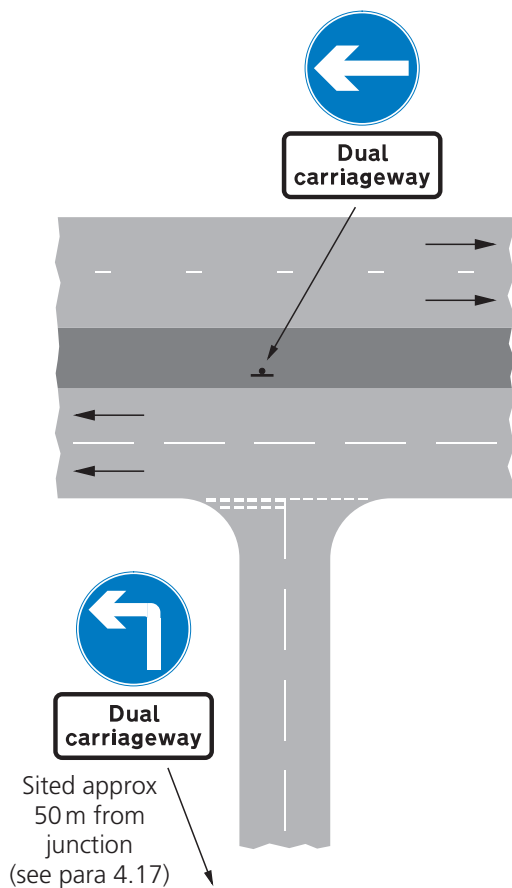
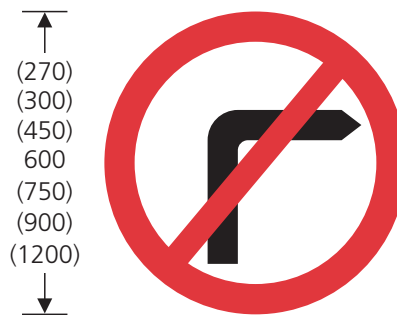

Figure 4-2

gap. The sign to diagram 606 with the "Dual carriageway" plate should be located to the left of the gap.

4.4 Signs to diagrams 606, 608 and 609 are not required where traffic joins a dual carriageway via a slip road and an acceleration lane, and the Give Way line is replaced by the marking to diagram 1010 (see figure 10-1 in Chapter 5). However, advance signs to diagram 609 and 608 might be helpful where it is not apparent to drivers that they are on a slip road, e.g. a former main road through a village joining a by-pass. Where a traffic merge warning sign is provided on the slip road (see section 2 in Chapter 4), this should be located in advance of the sign to diagram 609.

4.5 At an unsignalled junction where a side road forms a T-junction with a two-way road (see figure 4-3) and traffic is required to turn in one direction only, the use of a sign to diagram 606, even without a "One way" plate, could be misleading as drivers might think they are turning into a one-way road. A sign to diagram 612 or 613 should therefore be used at the junction, indicating the prohibited turn.



612 No right turn

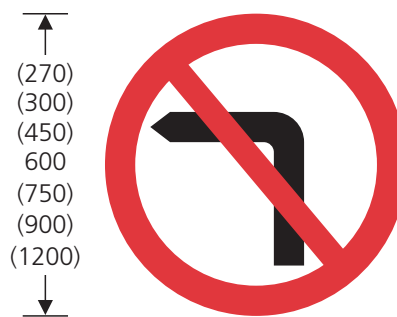

613 No left turn

These signs may be used with diagram 954, 954.2, 954.3, 954.4, 954.5, 954.6 or 954.7

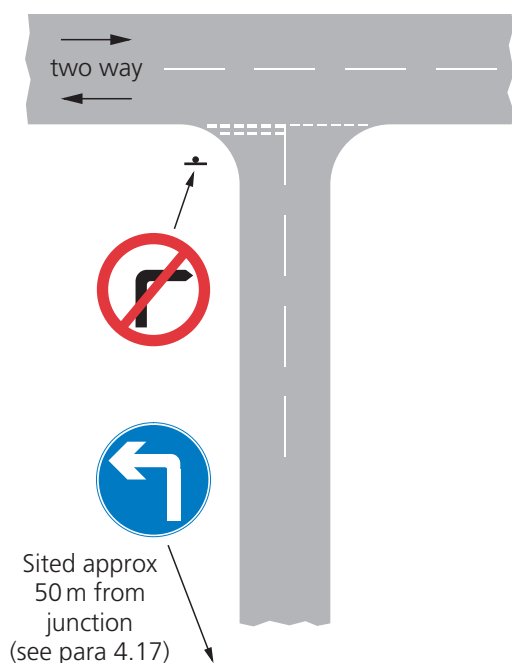

Figure 4-3

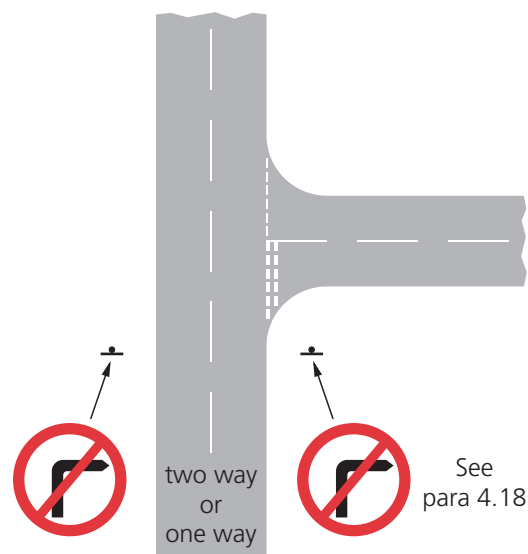

Figure 4-4

The road marking to diagram 1036.1 (TURN LEFT) or 1037.1 (TURN RIGHT) may be used to supplement the upright sign (see para 13.6 in Chapter 5). If a sign to diagram 609 is used in advance of the junction, it should be used without a supplementary plate. Where a map-type sign is provided in the side road, this should incorporate the “no right turn” or “no left turn” sign. Where the side road is one way and the main road is a single carriageway with two-way traffic, a warning sign to diagram 522 (two-way traffic) may be provided (see Chapter 4, para 5.4). This should be mounted above the “no right turn” or “no left turn” sign.

4.6 Where a major road at a crossroads is one way, the use of signs to diagrams 606 and 609 (see para 4.3) is not appropriate, as traffic can normally proceed ahead from the side road. In this situation, a “no right turn” sign to diagram 612 or a “no left turn” sign to diagram 613 should be used as appropriate. “One-way traffic” signs to diagram 652 should be provided in the major road within 50 m of the junction (see para 4.37).

4.7 Where traffic is prohibited from turning into a side road at an unsignalled T-junction (see figure 4-4), a sign to diagram 612 or 613 as appropriate should be provided at the junction. A map-type advance direction sign, if provided, should indicate

the prohibited turn by incorporating a diagram 612 or 613 roundel. This sign could be of the type shown in diagram 2010.1, 2010.2, 2123 or 2124, each showing an alternative route. The road marking to diagram 1036.2 (AHEAD ONLY) may be used to supplement the upright signs. Where the turn into the side road is prohibited because it is a one-way road controlled by “no entry” signs, it might not be necessary to provide signs to diagram 612 or 613. Situations where the “no right turn” and “no left turn” signs might be omitted are where the side road is narrow and of minor importance or where the “no entry” signs can be clearly seen from the main road when approaching the junction. Any map-type advance direction sign should incorporate the “no entry” roundel to diagram 616.

4.8 If traffic has to turn left or right at an unsignalled T-junction because the ahead manoeuvre is prohibited (see figure 4-5), a sign to diagram 609 may be used together with the road marking to diagram 1036.1 or 1037.1 as appropriate. It is not appropriate to provide a sign to diagram 606 pointing to the left or to the right. A plate to diagram 607 should be used with the sign only where traffic is turning into a one-way road. Any map-type advance direction sign should incorporate the appropriate regulatory roundel (e.g. “no entry” or “no vehicles”).

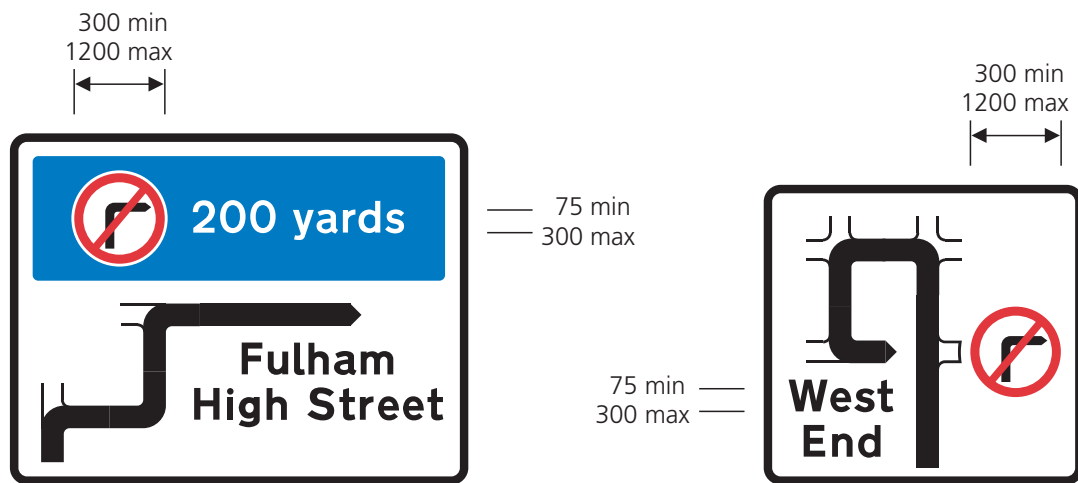

2123 Route avoiding prohibited turn on a non-primary route (2010.1 for primary route)

2124 Route avoiding prohibited turn on a non-primary route (2010.2 for primary route)

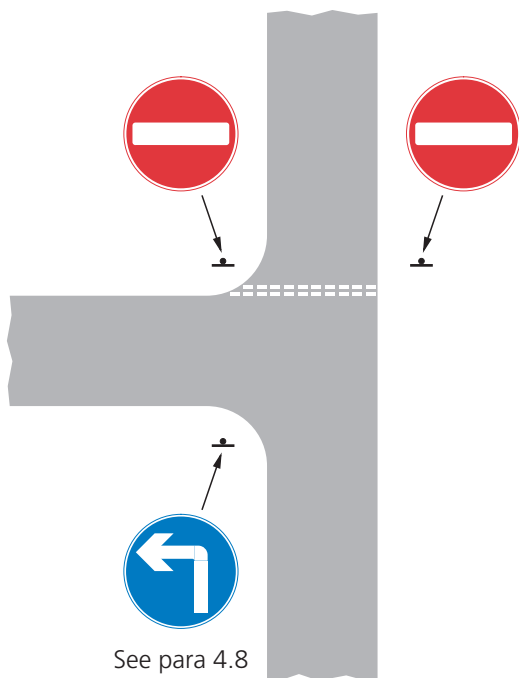

Figure 4-5

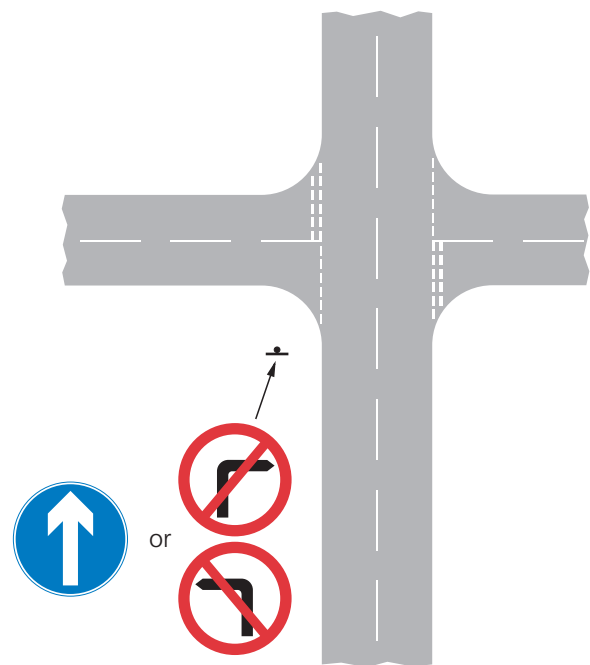

Figure 4-6

4.9 Where the junction is a priority crossroads controlled by STOP or GIVE WAY signs, any prohibited turn should be indicated by signs to diagram 612 or 613 located at the junction. The diagram 612 or 613 roundel should be incorporated in any map-type advance direction signs that are provided. Where the route through the junction is

ahead only (see figure 4-6), either a sign to diagram 606 pointing vertically upwards or both signs to diagrams 612 and 613 should be used. The sign to diagram 606 is normally used only at traffic signals and on one-way roads. The road marking to diagram 1036.2 (AHEAD ONLY) may supplement the upright signs.



818.2 Indication of a restriction ahead

The legend may be varied as appropriate (see Appendix B in respect of distance). An arrow may be added, pointing horizontally to the left or to the right

4.10 If the ahead manoeuvre is prohibited at a crossroads (e.g. the road opposite is a one-way road controlled by “no entry” signs) and both left and right turns are permitted, the only upright signs that can be provided on the approach to the junction to indicate the prohibition are a map-type advance direction sign that incorporates the “no entry” roundel (or other regulatory roundel as appropriate) and an informative sign to diagram 818.2. Directional arrows to diagram 1038 may be provided in the carriageway as appropriate. Where the only route through the junction is to the left or to the right, a sign to diagram 609 may be used at the junction, as shown in figure 4-7, together with the road marking to diagram 1036.1 or 1037.1 as appropriate. A plate to diagram 607 should be used with the sign only where traffic is turning into a one-way road. It is not appropriate to use a sign to diagram 606 pointing to the left or to the right at a crossroads (except where these are signal controlled, see paras 4.11 and 4.12). If the ahead manoeuvre is prohibited for only part of the day (e.g. a pedestrian zone) and either the left or right turn is prohibited, a sign to diagram 612 or 613 should be provided in place of the sign to diagram 609 (see figure 4-8). In this case the road markings to diagram 1036.1 or 1037.1 should not be provided.

4.11 At junctions controlled by traffic signals, the signs to diagram 606, 612 and 613 with a diameter of 300 mm may be mounted on the primary and secondary signals. They must be internally illuminated by day and by night. Unlike at uncontrolled junctions it is not appropriate to use a sign to diagram 609 at the junction itself as described in paras 4.8 and 4.10. However, if appropriate, a sign to diagram 609 may be erected on the approach to the junction.

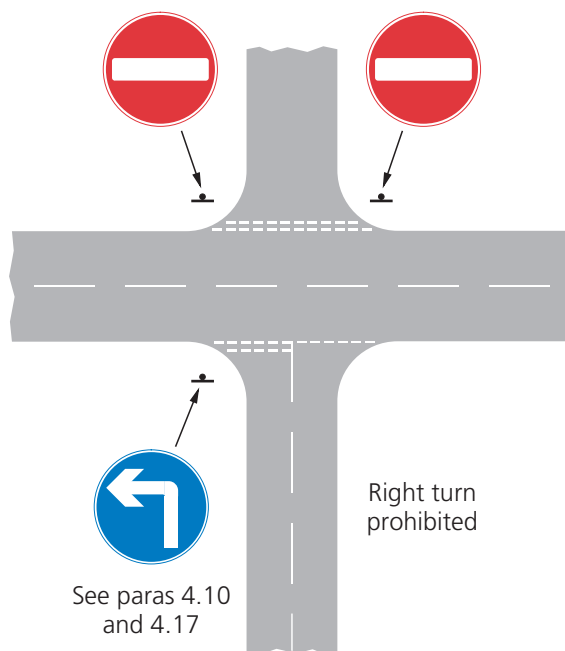

Figure 4-7

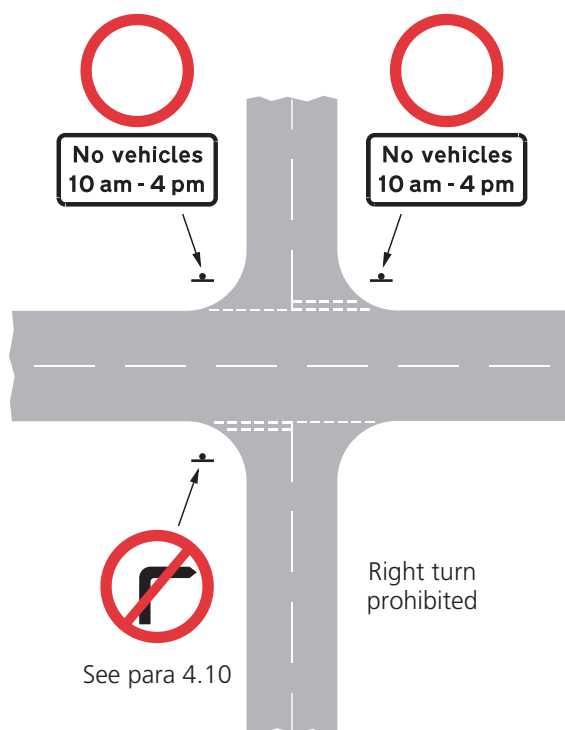

Figure 4-8

4.12 The “turn left” and “turn right” signs to diagram 606 should be mounted on the left or the right of the signal head respectively. The “ahead only” sign should be mounted on the carriageway side of the signal. The “no left turn” and “no right turn” signs should be mounted on the left or the right of the signal head respectively. Alternatively the signs may be mounted immediately below the green aspect. Where only one manoeuvre is permitted, the signal head should include a green arrow in place of a full green lens, to indicate the direction in which vehicles must proceed. Where both left and right turns are prohibited, a sign to diagram 606 pointing upwards should be used rather than both signs to diagrams 612 and 613. As at priority junctions, the signs at signal-controlled junctions may be supplemented by road markings to diagram 1036.1, 1036.2, 1037.1 or 1038 (see Chapter 5). Where appropriate, a sign to diagram 818.2 or a map-type sign incorporating regulatory roundels may be used on the approach to the junction.

4.13 Where there is a left turn filter slip road immediately in advance of traffic signals but not controlled by them, any “no left turn” sign relating to the signals should not be sited with the primary signal head unless this is at least 10 m beyond the plain-faced bollard at the dividing nose. Where the distance is less, the sign should be mounted only on the secondary signal head.

SUPPLEMENTARY EXCEPTION PLATES

4.14 A traffic regulation order restricting the movement of vehicles through a junction may provide exceptions for buses, cycles and taxis. In such cases the signs to diagrams 606, 609, 612 and 613 may be used with a supplementary plate excepting buses, local buses, cycles and taxis as appropriate. Exception plates to diagrams 954, 954.2, 954.3 and 954.4 are rectangular; their appropriate sizes are specified in Appendix A. Exception plates to diagrams 954.5, 954.6 and 954.7 are circular with a diameter of 300 mm for use with signs mounted on traffic signal heads and must be internally illuminated by day and by night.

4.15 Supplementary plates to diagrams 607 (One way) and 608 (Dual carriageway) should not be used with signs that have exception plates as this could cause confusion and might be hazardous.



954 Buses excluded from prohibition



954.2 Local buses excluded from prohibition



954.3 Buses and cycles excluded from prohibition

The word “local” may be added before “buses”. “buses and cycles” may be varied to “buses, taxis and cycles”, “buses, taxis & cycles” or “buses and taxis”

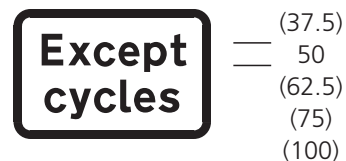

954.4 Cycles excluded from prohibition

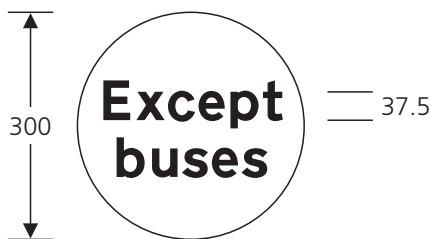

954.5 Buses excluded from prohibition

"buses" may be varied to "cycles"



954.6 Buses and cycles excluded from prohibition

"buses & cycles" may be varied to "local buses" or "buses & taxis"



954.7 Buses, taxis and cycles excluded from prohibition

"buses, taxis & cycles" may be varied to "local buses & cycles" or "local buses & taxis"

These signs may be used only in combination with regulatory signs mounted on traffic signal heads

SITING OF SIGNS AT JUNCTIONS

4.16 Where a sign to diagram 606 pointing to the left or to the right is required, it is always sited opposite the junction or on the central reservation of a dual carriageway road (see figures 4-1 and 4-2), unless it is mounted on a traffic signal head. When pointing upwards, the sign to diagram 606 is sited immediately before the junction, not in advance and not on the far side of the junction (except when mounted on a secondary signal head).

4.17 A sign to diagram 609 is usually mounted in advance of a junction at a distance of approximately 50 m. This distance might need to be varied if another junction intervenes or where there are other constraints. In one-way roads that are wide enough for two lanes of traffic, the sign should be sited on both sides of the road. Where the ahead manoeuvre is prohibited and traffic can either turn left only or right only (see paras 4.8 and 4.10), the sign should be sited immediately before the junction on the left hand side (see figure 4-7) and may be duplicated on the right hand side of a one-way road or on a central refuge in a two-way road.

4.18 A prohibited turn sign to diagram 612 or 613 is always sited immediately before the junction on the left hand side. Where there are two or more approach lanes and a "no right turn" sign is likely to be obscured by vehicles in the near side lane, the sign should be duplicated either on the right hand side of the road or on any central refuge. There might be other situations where it would be helpful to duplicate either the "no right turn" or "no left turn" sign, e.g. where the near side lane is reserved for buses and the left turn is prohibited. On dual carriageways, signs should normally be mounted on both the left hand side and the central reservation. At a signal-controlled junction the sign should be mounted on the primary and secondary signal heads.

ROUNDBABOUTS

4.19 The sign to diagram 606 pointing to the left may be used without a traffic regulation order on central islands of roundabouts, where it is normally accompanied by the deviation of route sign to diagram 515 (see Chapter 4, paras 3.12 to 3.22). On very small roundabouts, other than mini-roundabouts, the sign may be mounted in a traffic bollard, in which case it will normally have a diameter of 270 mm.

4.20 A sign to diagram 611.1 is used at mini-roundabouts and requires that vehicles entering a junction marked with diagram 1003.4 (see Chapter 5, paras 8.10 to 8.17) must give priority to vehicles from the right at the transverse broken line to diagram 1003.3, (see also para 4.23). If the transverse line is temporarily not visible, e.g. because of road works, priority must be given to traffic from the right at the road junction. The provision of this sign does not require a traffic regulation order. "Turn left" signs to diagram 606 are not used at mini-roundabouts.

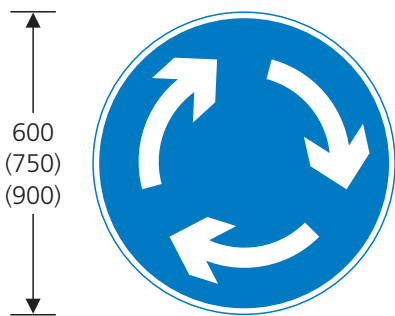

611.1 Mini-roundabout

May be used only in conjunction with diagram 1003.4 and with either diagram 1003.3, or with diagrams 1003 and 602 together. It may also be used with diagram 1023

4.21 The sign to diagram 611.1 should be placed on each approach to a mini-roundabout junction, in the correct orientation as shown in the diagram, at a distance of approximately 1.5 m before the transverse line. This might have to be increased if the sign would not otherwise be clearly visible, but to no more than 12 m. The sign may be duplicated on a traffic island in the middle of the road. To avoid misleading drivers, care should be taken when siting signs at a double mini-roundabout to ensure that the signs for each roundabout are not too close to each other. Advance warning of the roundabout may be given by the sign to diagram 510 (see para 2.16 in Chapter 4) or by an advance direction sign to diagram 2024, 2119 or 2120.

4.22 Three sizes of the sign to diagram 611.1 are prescribed (see Appendix A). As mini-roundabouts are only recommended for roads with a speed limit of 30 mph or less, the size normally used is 600 mm diameter. Larger sizes might be needed on wide approaches.

4.23 Sometimes adequate deflection to the left cannot be provided at the entry to a three-armed mini-roundabout (see Chapter 5, figure 8-3). Drivers entering the roundabout at relatively high speeds then frequently disregard the standard advisory Give Way line (diagram 1003.3). Provided that there is no side road entering from the left, the GIVE WAY sign to diagram 602 may be mounted above the mini-roundabout sign on this approach. The transverse marking to diagram 1003 and the triangular marking to diagram 1023 must then also be used (see Chapter 5, para 8.17). The GIVE WAY sign should not be used where a road enters from the left of the approach in question, on the stem of a T-junction or on any arm of a four-way junction, as experience has shown that drivers can be confused into believing they have to give way to traffic approaching from the left.

KEEP LEFT, KEEP RIGHT, PASS EITHER SIDE

4.24 The "keep left" sign to diagram 610 may be erected without an order. It is used at traffic islands, refuges and on the central reservations of dual carriageway roads. At the start of a dual carriageway, it may be accompanied by the plate to diagram 608 (Dual carriageway). It is also used extensively at road works to indicate the required movement of vehicles past the works area (see Chapter 8).

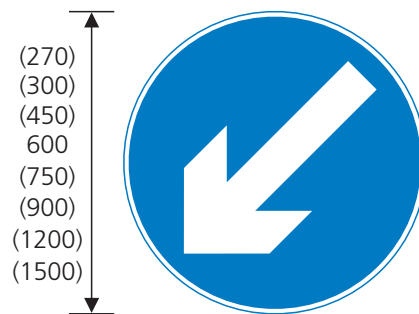

610 Vehicles must pass on the side indicated

May be used with diagram 608. The arrow may point downwards to the right

4.25 The "keep left" sign is not normally used at the exit from roundabouts, as circulating traffic necessarily passes to the right of the sign. A plain-faced bollard would generally be used in this situation, but might not be necessary where direction signs have been provided. However, where there is

only a narrow refuge on the roundabout exit, and not a triangular splitter island, the “keep left” sign may be used. The sign should be used at the recommencement of a central reservation following a gap, as traffic turns right in front of the sign without actually passing it.

4.26 The sign may be varied to indicate “keep right”; this is sometimes used in permanent situations such as traffic calming schemes and also in association with road works.

4.27 The “pass either side” sign to diagram 611 is for use on traffic islands, usually situated in one-way roads, where drivers passing either side of the sign reach the same destination immediately beyond. It must not be used in situations where drivers would become committed to different destinations once they had passed the sign. In this case, a plain-faced bollard should normally be provided, although it might not be required where direction signs have been erected on the traffic island.

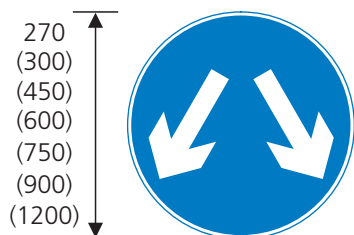

611 Pass either side

4.28 The sizes of 270 and 300mm for signs to diagrams 610 and 611 are intended for use in bollards, although some bollards will accommodate larger sizes. Sizes of 450mm and above are intended for use at higher level or for free-standing signs at road works (see Appendix A). Where a sign is mounted in a bollard, especially where the speed limit is greater than 30mph, a larger post-mounted sign may also be provided at the same location to give greater emphasis.

PRIORITY SIGNS

4.29 The sign to diagram 615 indicates that drivers must give priority to vehicles from the opposite direction on a narrow length of road. It should be used only when vehicles at each end of the priority section are clearly visible to each other and speeds

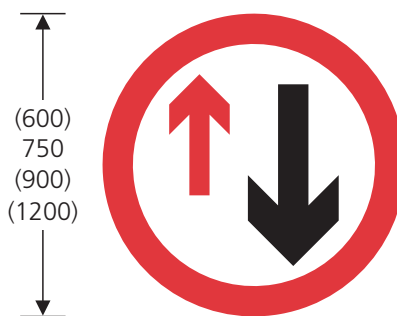

615 Priority must be given to vehicles from the opposite direction

May be used only in combination with diagram 615.1 or 645 and only in conjunction with diagram 811. May be used with diagram 1003, 1023, 1043 or 1044



615.1 Give way to oncoming vehicles

May be used only in combination with diagram 615. The word "for" and a distance may be added (see Appendix B)

are not high. The sign must not be displayed to traffic approaching from both directions. It must never be used upside down in an attempt to imply reversed priority. The sign must always be accompanied by the supplementary plate to diagram 615.1 (Give way to oncoming vehicles) at the start of the priority section.

4.30 The sign to diagram 811, together with the plate to diagram 811.1 (Priority over oncoming vehicles) must be mounted to face traffic approaching from the other direction. As with diagram 615 above, this sign must never be used upside down in an attempt to imply reversed priority.

4.31 Unless the limits of the priority section are obvious, e.g. through the arch of a bridge, the plates to diagram 615.1 and 811.1 should be varied to include the distance over which the priority applies,

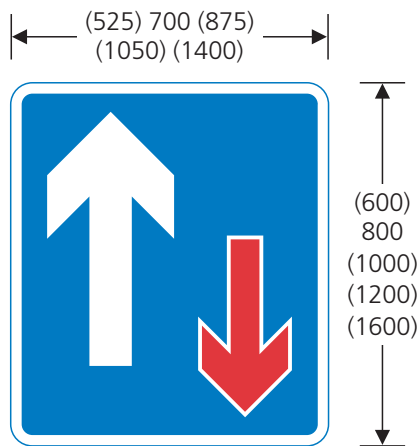

811 Traffic has priority over vehicles from the opposite direction

May be used only in combination with diagram 645 or 811.1. May be used only in conjunction with diagram 615. May be used with diagram 1043 or 1044

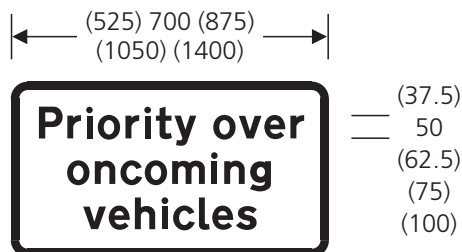

811.1 Priority over oncoming vehicles

May be used only in combination with diagram 811. The word "for" and a distance may be added (see Appendix B)

as shown on working drawings P 615.1 and P 811.1 (see para 1.9). Where the distance is indicated, signs to diagram 615 and 811 as appropriate, each with an "End" plate to diagram 645, should be located at the termination of the priority section.

4.32 Where a priority system is used on a gradient steeper than about 2.5 %, the sign to diagram 615 should be mounted to face descending traffic. Where the gradient is less and the road narrows on one side only, the sign to diagram 615 should be mounted to face traffic approaching on that side of the road. In other cases the sign should be erected to face traffic which tends to give way more readily.

4.33 To give greater emphasis to the sign to diagram 615, the Give Way line and triangle to diagrams 1003 and 1023 may be used (see Chapter 5, para 3.24), but not the upright sign to diagram 602. When used in conjunction with a Give Way line, the sign should normally be sited about 1.5 m before the marking.

4.34 Where the width of the priority section is less than 4.5 m at its narrowest point, a yellow box to diagram 1043 or 1044 may be used to prevent vehicles from queuing back into the section and obstructing the flow from the opposite direction (see Chapter 5, para 12.13). This is appropriate only where queues are likely to form, for example near a junction, beyond the priority section.

ONE-WAY ROADS

4.35 The "one-way traffic" sign to diagram 652 may be used only to indicate the effect of a traffic regulation order which requires vehicles to proceed in one direction only. It should not be used to sign traffic along one carriageway of a dual carriageway road. However, where a rural dual carriageway comprises two one-way roads (i.e. where there is non-highway land between the two carriageways) each carriageway should be subject to a one-way traffic order and signs to diagram 652 provided accordingly. The ahead arrow road marking to diagram 1038 may be used in conjunction with the "one-way traffic" sign.

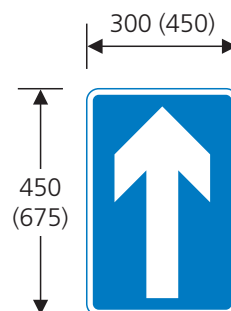

652 One-way traffic

4.36 A sign to diagram 652 should be erected on each side of the carriageway at the point of entry to a one-way road. The signs should be carefully sited to avoid possible confusion over which road they apply to. When the one-way road forms a junction with the

side of another road, the signs should be sited in line with the backline of the major road, although they may be placed a short distance into the one-way road if this enables advantage to be taken of a convenient mounting point such as a lamp column. It may be desirable to orientate the sign to suit the direction of approaching traffic. Note that if mounted within 50 m of a junction from which traffic may approach the sign, the signs must be lit if the road is lit (Schedule 17, item 1). This also applies to junctions within the one-way road (see para 4.37). Direct lighting of the signs in these circumstances ensures that drivers can see the signs at night where the headlamps of turning vehicles are unlikely to provide sufficient illumination from retroreflection.

4.37 Repeater signs to diagram 652 should be erected so that there are signs alternately on each side of the road and the distance between consecutive signs on alternate sides is not more than 100 m. When a side road enables traffic to enter a one-way road, a repeater sign should be erected on the main road to face traffic within 50 m of the entry point, unless signs to diagrams 606 and 607 have been provided (see paras 4.3 and 4.6). Where the signs are used on a rural dual carriageway comprising two one-way roads (see para 4.35), the signs should be mounted in pairs, with consecutive pairs being approximately 400 m apart.

4.38 The ONE WAY sign to diagram 810 is an informatory sign for pedestrians. It should be used at locations where pedestrians regularly cross the road, particularly where traffic is approaching from the left. It must never be used in place of diagram 606 when aimed at vehicular traffic. At pedestrian crossing points the LOOK LEFT or LOOK RIGHT road marking to diagram 1029 may be used (see Chapter 5, paras 22.26 to 22.28).



— 40
(50)
(60)

**810 One-way traffic in direction indicated
(Sign for pedestrians)**

The arrow may point to the left

4.39 The “no entry” sign to diagram 616 should be placed on each side of a one-way road at the point where entry is prohibited (direction 8). When the road to which the signs apply forms a junction with the side of another road, the signs should be sited in line with the backline of the major road. The signs must be placed so that one is clearly visible at all times to traffic approaching from any permitted direction; this might require a sign to be angled slightly. Care should be taken in siting the signs to avoid the possibility of drivers misunderstanding which road they apply to.

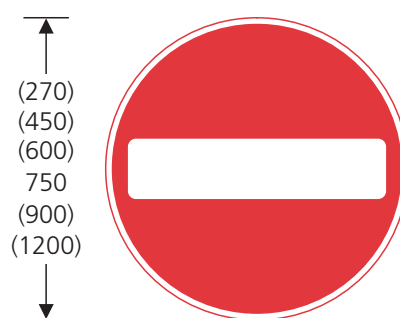

616 No entry for vehicular traffic

May be used with diagram 954 or 954.2. May be used with the road marking shown in diagram 1046

4.40 Exceptionally, at a junction where the signs apply to a side road and the carriageway of that road is less than 5 m wide (see direction 8), it might be possible to use a single sign, sited no more than 2 m from the carriageway edge, provided that it can be readily seen by all drivers who might otherwise attempt to enter the prohibited road. The Directions also permit a single sign to be used where the main route through the junction is one way, regardless of the width of the side road to which the “no entry” prohibition applies. In this case the sign should be placed on the far side of the prohibited road when viewed from the direction of travel on the main route.

4.41 The upright “no entry” signs may be supplemented by the NO ENTRY road marking to diagram 1046 (see Chapter 5, paras 22.29 to 22.32).

4.42 Where a one-way street order excepts buses, i.e. to introduce a contra-flow bus lane, the sign to diagram 953 with the plate to diagram 953.2 (Only) should be used (see para 15.21). Although the

Directions permit supplementary plates to diagram 954 (Except buses) and 954.2 (Except local buses) to be used with diagram 616, this is no longer recommended, as the primary use of the “no entry” sign is to protect the end of a one-way road, where it would be hazardous and endanger the safety of road users should the sign be ignored. No other plates are prescribed or permitted for use with the “no entry” sign. Exception plates for cycles (diagrams 954.3 and 954.4) are prohibited by direction 21(2) from being used with the “no entry” sign. Where cyclists are to be admitted, signs to diagram 953 or 955 should be used in place of the “no entry” sign, or a cycle by-pass constructed. Where access to a two-way street is restricted to a particular class of vehicle or for a specific purpose (e.g. loading), a sign to diagram 617 (no vehicles) or 619 (no motor vehicles) should be used with an appropriate exception plate. For further details on contra-flow bus lanes and contra-flow cycle facilities see sections 15 and 17 respectively.

4.43 Where a traffic bollard is situated at the exit from a one-way road, it may be fitted with a 270 or 300 mm diameter “no entry” sign to stop vehicles entering from the opposite direction. This sign should be used only in addition to, and not in substitution for, the larger signs. The “no entry” symbol may also be incorporated into map-type advance direction signs (see para 4.7).

NO ENTRY SIGNS (OTHER THAN ONE-WAY ROADS)

4.44 Exceptionally, “no entry” signs may be used without an order; but only with the written approval of the Secretary of State (direction 7(3)). Such approval will be given only where it is proposed to use the sign for safety reasons in circumstances where this would not prohibit an otherwise permitted movement. This procedure must not be used to prohibit completely a particular turning manoeuvre at a junction or to prevent access at the end of a segregated lay-by on a single carriageway road. If this is necessary, a traffic regulation order must be made. Circumstances where an order is not required might include guiding drivers at channelising traffic islands, e.g. when approaching a roundabout or when turning right into a side road.

4.45 “No entry” signs might also be used to reduce the risk of traffic entering the wrong carriageway of a dual carriageway road or travelling in the wrong

direction along a slip road. They should not, however, be provided as a matter of course, but only where there is a genuine risk of confusion. “No entry” signs are unlikely to be justified where an acceleration lane is provided for traffic joining a dual carriageway road. Superfluous signing is not only unnecessary, it is unsightly and can distract or confuse drivers on the opposite carriageway.

4.46 At a junction with a dual carriageway where there is no gap in the central reservation (i.e. all traffic from the side road turns left), diagram 606 with a plate to diagram 608 should be sufficient without the need for “no entry” signs (see figure 4-2 and para 4.3). Where there is a gap in the central reservation and traffic can turn right into the dual carriageway from the side road, “no entry” signs might be beneficial to deter drivers from turning into the wrong carriageway. Where the junction is controlled by traffic signals, the signs would usually not be necessary.

4.47 The NO ENTRY road marking to diagram 1046 (see Chapter 5, paras 22.29 to 22.32) may be used in the situations described above, with or without associated upright “no entry” signs, and will also require written approval.

NO U-TURNS

4.48 The “no U-turn” sign to diagram 614 is used to give effect to an order which may apply to a junction or a length of road. At signal-controlled junctions, 300 mm diameter signs should be mounted either alongside and to the right of, or immediately below the green aspect of the duplicate primary and the secondary signals. At junctions not controlled by signals, the sign should be mounted on the central

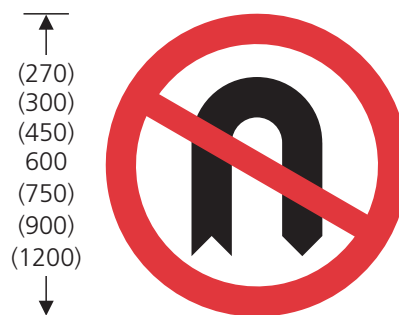

614 No U-turns

May be used with diagram 570 or 645

refuge or reservation as close as practicable to the junction to face traffic approaching from the direction the prohibition applies to. Where there is no central island, a sign should be mounted on both the left hand and right hand side of the road.

4.49 Where the prohibition applies to a single gap in the central reservation on a dual carriageway road, a sign of the size appropriate to the speed of traffic should be erected on both sides of the carriageway just before the gap (see Appendix A).

4.50 Where the prohibition applies to a length of road, the start should be signed using a pair of signs to diagram 614, one on each side of the road or, in the case of a dual carriageway, on each side of the carriageway. Both signs should have a supplementary plate to diagram 570 showing the distance over which the prohibition applies. A sign and distance plate should also be erected within 50m of each point of entry from a side road. Elsewhere repeater signs, without distance plates, should be provided at intervals of about 100m or, on dual carriageway roads, just before each break in the central reservation. Unlike speed limit and rural clearway signs, the repeater signs should be the full size appropriate to the speed of traffic (see Appendix A).



570 Distance over which restriction extends

The distance may be varied (see Appendix B)

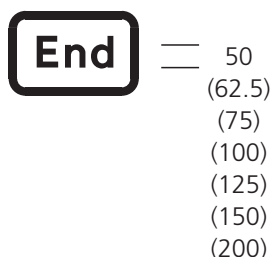

645 End of restriction

4.51 At the end of a restriction, the sign to diagram 614 should be mounted with the “End” plate to diagram 645, back to back with the start of prohibition signs, on both sides of the road or carriageway.

NO OVERTAKING

4.52 The sign to diagram 632 is used to give effect to an order which prohibits overtaking. Such orders will be exceptional as situations where forward visibility makes overtaking hazardous can normally be dealt with by double white lines. “No overtaking” signs must not be used along the same length of road as double white lines. Situations where an order might be appropriate include:

- (i) roads which are less than 6.1 m wide, thereby making double white lines impracticable (see Chapter 5, para 5.4), and
- (ii) roads along which the stopping restrictions imposed by double white lines would not be acceptable.

“No overtaking” signs might also be used at road works, where a temporary order will be required (see Chapter 8). Where a road is prone to ice during most winters, an order can be made to prohibit overtaking when traffic signs are displayed. In this case the sign to diagram 632 should be supplemented by the “Ice” plate to diagram 554.3 (see Chapter 4, paras 11.7 and 11.8).

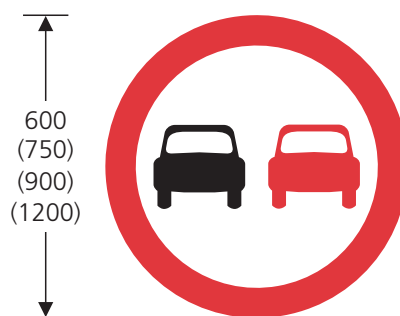

632 No overtaking

May be used with diagram 554.3, 570 or 645

4.53 The “no overtaking” sign should be erected on each side of the road (direction 8) at the start of the affected length and should be supplemented by distance plates to diagram 570. At the end of the restriction, signs to diagram 632 should be used supplemented by “End” plates to diagram 645. Appropriate sign and plate sizes are specified in Appendix A.

4.54 Repeater signs to diagram 632 and distance plates should be erected at intervals not exceeding 400 m. Where a side road enables traffic to enter part way along a restricted length, signs and plates should be erected on both sides of the major road within 50 m either side of the junction so that they are seen by drivers turning right or left from the minor road. Repeater signs are the same size as the terminal signs.

STOP POLICE

4.55 The sign to diagram 633 may be placed only by a police officer in uniform or a person acting under the instructions or authority of the chief officer of police. The sign gives an instruction to drivers not to proceed beyond it. It may be placed on a highway for a period not exceeding seven days in accordance with section 67 of the Road Traffic Regulation Act 1984. By virtue of regulation 54 of the Traffic Signs Regulations and General Directions 2002, a police officer, or anyone acting under police instructions, may place a flashing blue lamp with the sign.



633 Vehicular traffic must not proceed beyond the sign where displayed temporarily by a constable in uniform or a person acting under the instructions or authority of the chief officer of police

5 PROHIBITION OF TRAFFIC

GENERAL

5.1 This section describes the group of signs that prohibit traffic or categories of traffic (including pedestrians) from certain roads. It includes signs that prohibit vehicles because of their weight or size. Except where stated otherwise, the signs may be used only to give effect to a traffic regulation order etc. (direction 7). Signs relating to pedestrian zones will be found in section 11. See Appendix A for sizes of signs and supplementary plates and para 5.44 for the siting of signs.

5.2 When width, height, length or weight limit signs are used, it is important that the alternative route is clearly signed not only at the start of the diversion but also at the last place where a vehicle can divert, even though this might not be the preferred diversion route. Signing should be continued at junctions along its entire length, using directional signs including where appropriate "avoiding" or "alternative route for" legends in accordance with Schedule 16, item 32 (see also Chapter 7, paras 3.37 and 3.38). In some cases it might be more appropriate to sign advisory

lorry routes using signs to diagrams 2805, 2806 and 2806.1 or by incorporating black lorry route panels on primary route and non-primary route directional signs where permitted (see Schedule 16, item 25).

5.3 Advance warning of certain restrictions may be given by incorporating the prohibitory sign into direction signs or advance direction signs in accordance with Schedule 16, item 31 and as indicated in diagram 2003 (see also Chapter 7). These are not a substitute for the terminal signs that indicate the start of the restriction (see para 5.44). Unless the restriction begins at the junction, either on the main road or on the side road, a distance plate should be included so that drivers can judge whether they can reach a particular property or destination before reaching the restriction. It should be noted that exception plates cannot be included on these signs. The restrictions that may be signed in this way are:



2805 Advance direction sign indicating a route advised for goods vehicles

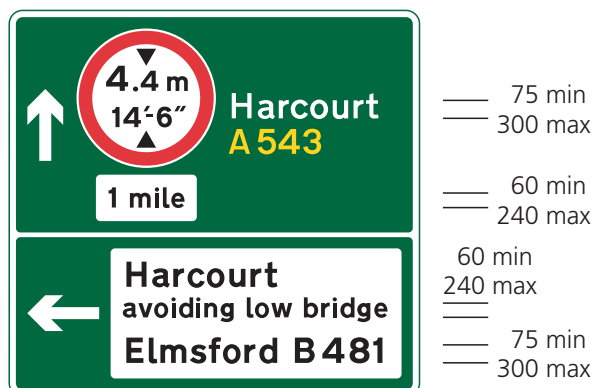

2003 Advance direction sign indicating a height restriction ahead with an alternative route to the left (Sign on a primary route)

- (i) No vehicles (diagram 617 with diagram 618.1 varied to "No vehicles" with or without a distance; exceptions are not permitted)
- (ii) No motor vehicles (diagram 619)
- (iii) No motor vehicles except solo motor cycles (diagram 619.1)
- (iv) No solo motor cycles (diagram 619.2)
- (v) Environmental weight limit (diagram 622.1A)
- (vi) No horse-drawn vehicles (diagram 622.5)
- (vii) No towed caravans (diagram 622.7)
- (viii) No vehicles carrying explosives (diagram 622.8)
- (ix) Structural weight limit (roundel only from diagram 626.2A)
- (x) Width limit (diagram 629 or 629A)
- (xi) Length limit (diagram 629.1)
- (xii) Height limit (diagram 629.2 or 629.2A)
- (xiii) No buses (diagram 952).

5.4 An alternative to incorporating a prohibitory sign in a directional sign is to use a sign to diagram 818.3 or 818.4. In many cases this can reduce the overall size of an advance direction sign as shown in figure 5-1 and should be considered where sign overload is likely to occur.

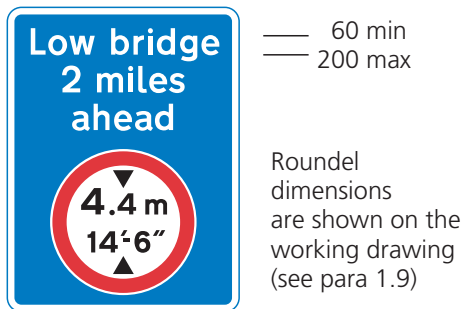

818.3 Mandatory height limit at low bridge ahead

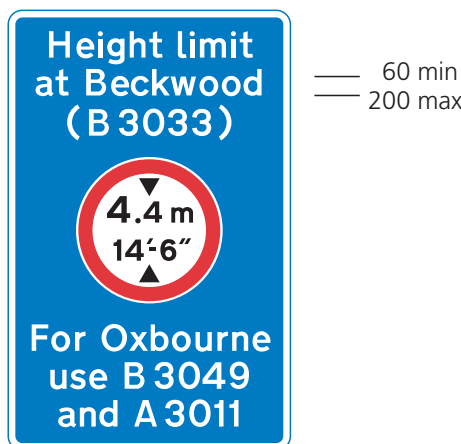

818.4 Mandatory height limit ahead and indication of alternative route

The legend, with the appropriate roundel, may indicate a weight, width or length limit. An arrow may be added (with "ahead" omitted). The location and alternative route shown on diagram 818.4 may be varied as appropriate and may include a reference to a motorway junction. A diversion route symbol may be added. The sign to diagram 818.3 may include an alternative route. The distance may be varied (see Appendix B). Details of the permitted variants are shown in Schedule 16 and in the table below each diagram in the Regulations

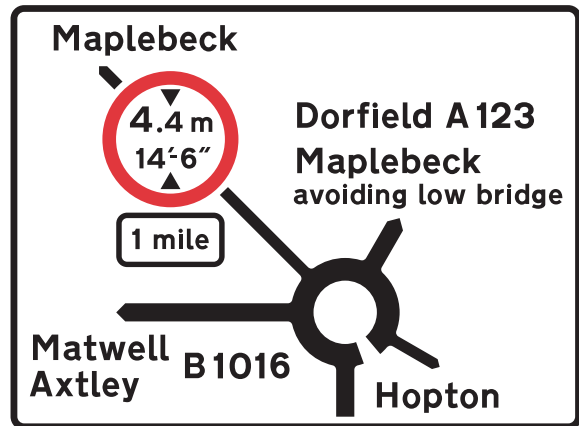

Single sign: This can be very large and might be difficult to site where there is limited verge width

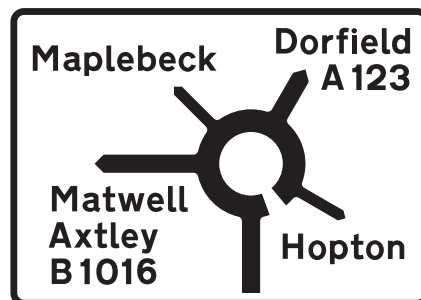

Two signs: These can provide a more compact arrangement. The sign to diagram 818.3 or 818.4 should be sited upstream of the advance direction sign for the junction

Figure 5-1 Alternative methods of indicating a restriction on a road at a junction ahead

ALL VEHICLES PROHIBITED AND PLAY STREET

5.5 The sign to diagram 617 prohibits all vehicles including ridden pedal cycles and horse-drawn vehicles. Normally it is used either for play streets (where vehicles are admitted only for access) or for shopping streets closed to vehicles and where even ridden pedal cycles would be a hazard to pedestrians. The sign must always be used in combination with a supplementary plate to either diagram 618 or 618.1. The signs are used where the prohibition applies to the whole of the road in both directions; they should not be used to indicate one-way or tidal-flow traffic systems. The majority of vehicle-free shopping streets are likely to be pedestrian zones, where a sign to diagram 618.2, 618.3 or 618.3A should be used in place of diagram 617 (see section 11).

5.6 The plate to diagram 618 is used to indicate a play street. It may be used only in combination with diagram 617 and it may be used with the road marking to diagram 1046 varied to PLAY STREET. The time of day may be varied and days of the week added, but access must be maintained at all times.

5.7 Elsewhere, diagram 617 is used with the plate to diagram 618.1 to indicate that vehicles are prohibited. The legend may be varied as below but must always include the words "No vehicles". The permitted exceptions allowing entry into the street are:

- (i) for access
- (ii) for loading (or "for loading by" plus the lorry symbol)
- (iii) permit holders (with or without an identifier)
- (iv) disabled badge holders (blue badge symbol)
- (v) buses (or local buses) – see para 15.29
- (vi) taxis
- (vii) for access to off-street premises
- (viii) any appropriate combination of the above (note that (ii) and (vii) must not be used with "for access").

In addition, the times of day may be varied or omitted, and days of the week may be added. These may relate to the period of operation of the order, to the period when the exceptions apply or to both. The recommended layouts for the various combinations of exceptions are shown on working drawing P 618.1 (see para 1.9).

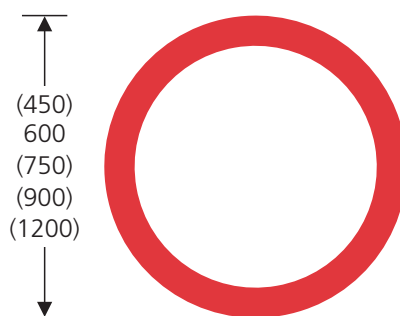

617 All vehicles prohibited

May be used only in combination with a sign to diagram 618 or 618.1



618 Play street

May be used only in combination with a sign to diagram 617 and may be used with the marking to diagram 1046 varied to PLAY STREET. The times of day may be varied or omitted



618.1 No vehicles except for access

May be used only in combination with a sign to diagram 617. See para 5.7 for permitted variants

5.8 It is unlikely that the plate to diagram 618.1 will show only the legend "No vehicles". This would be appropriate only where vehicles are prohibited at all times and access is not permitted. Example of such roads might be a public footpath or a wide footbridge (with a level approach or ramp) that has been constructed to allow the passage of emergency or maintenance vehicles. To emphasise that ridden cycles are prohibited, consideration could be given to providing a CYCLISTS DISMOUNT sign to diagram 966 (see para 17.37). There would need to be alternative access to any premises situated along the road. The length of road affected might be very short where a through route is stopped up part way along its length, effectively creating two culs-de-sac to prevent rat running. In such situations it might be possible to construct a physical barrier. Signs to diagrams 617 and 618.1 might then not be required. If the total ban on vehicles applies during part of the day only, a time period is added to the "No vehicles" plate. Alternatively, a variable message sign could be used and the plate need only display "No vehicles". The disadvantage of using a variable message sign is that drivers entering the street during the periods when this is permitted will not know that they will have to leave by a certain time.

PROHIBITION OF MOTOR VEHICLES

5.9 The sign to diagram 619 gives effect to an order which prohibits the use of a road by motor vehicles. Diagram 619.1 prohibits motor vehicles other than solo motor cycles, scooters or mopeds, and diagram 619.2 prohibits solo motor cycles.

5.10 The sign to diagram 619 is the most commonly used of the three. It is likely to be used to keep motor vehicles out of certain roads or a length of road for environmental reasons and where cyclists would not be a hazard to pedestrians. The sign should not be used to indicate one-way or tidal-flow traffic systems. However, it may be used to indicate the start of an advisory contra-flow cycle lane where it is not possible to provide a traffic island (see para 17.27). A "no motor vehicle" restriction might be appropriate for narrow streets in villages and for shopping streets in towns and cities where full pedestrianisation is not appropriate. Where there is a need to reduce the level of unnecessary traffic in a residential street, a prohibition of motor vehicles except for access might sometimes be preferable to stopping up the road and creating a cul-de-sac.

5.11 Diagram 619.1 would be used where it was acceptable to permit solo motor cycles (i.e. without side cars) to use the road where other motor traffic is prohibited. Diagram 619.2 might be used where it is required to emphasise that solo motor cycles are not permitted to use a route that has been provided for pedestrians and cyclists.

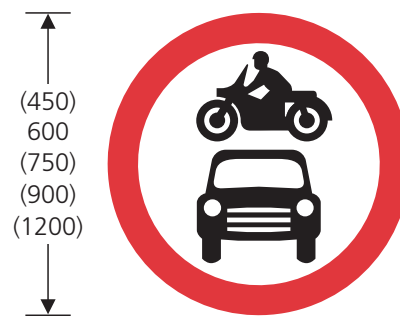

619 Motor vehicles prohibited

May be used with diagram 620 or 620.1

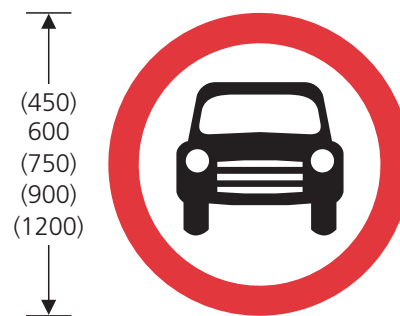

619.1 Motor vehicles except solo motor cycles prohibited

May be used with diagram 620 or 620.1

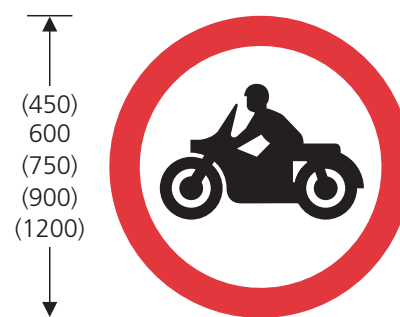

619.2 Solo motor cycles prohibited

May be used with diagram 620

5.12 A sign to diagram 619, 619.1 or 619.2, unlike the sign to diagram 617, does not have to be used with a supplementary plate. However, it is rarely desirable to deny access to premises or land adjacent to a road, so a plate to diagram 620 (Except for access) should be used with these signs if the traffic order permits. If access is permitted for loading by goods vehicles only, the signs to diagrams 619 and 619.1 should be accompanied by the exception plate to diagram 620.1. Both plates may indicate the time of day, the day of the week or the month of the year, as appropriate, where the order does not apply continuously or where the exceptions apply only at certain times. The plate to diagram 620 may be varied to show the same exceptions as for the plate to diagram 618.1 (see para 5.7). Some exceptions are not applicable when the plate is used with the sign to diagram 619.2.



620 Except for access

May be used only in combination with one of the signs to diagram 619, 619.1, 619.2, 622.1A, 622.5, 622.6, 622.7, 622.8, 629, 629A, 629.1 or 952.

Times, days and months may be added. The permitted variants detailed in para 5.7 may be used



620.1 Except for loading by goods vehicles

May be used only in combination with diagram 619 or 619.1. Times, days and months may be added

PROHIBITION OF BUSES

5.13 The sign to diagram 952 is used to give effect to a prohibition of buses. For this purpose, regulation 24(1) defines a bus as:

- (i) a motor vehicle constructed or adapted to carry more than 8 passengers; or
- (ii) local buses of any capacity.

A local bus is defined in regulation 4 as a public service vehicle used for the provision of a local service not being an excursion or tour, where "local service" has the meaning given in section 2 of the Transport Act 1985.

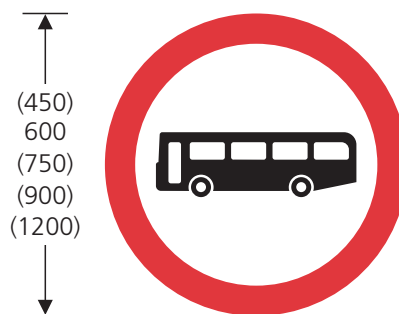

952 Buses prohibited

May be used with diagram 620 or 954.2



954.2 Local buses excluded from prohibition

The legend may be on three lines

5.14 An order prohibiting buses is likely to be made where country lanes are narrow and inappropriate for buses or where buses are likely to cause a nuisance to residents. As local buses follow scheduled routes, the prohibition will be aimed at other buses, including

school buses and tour operators. The prohibition will also apply to mini-buses (public or private) that have 10 or more seats (including the driver's seat). There might therefore be exceptions to the prohibition. The sign to diagram 952 may be used with a supplementary plate to either diagram 620 (Except for access) or 954.2 (Except local buses). The latter is appropriate where the order applies to a local bus route and it is required to prohibit other buses (e.g. where the road might be used as a short cut to a tourist destination that attracts a large number of tour buses). The permitted variants of diagram 620 that would be appropriate for a bus prohibition are:

- (i) Except for access
- (ii) Except permit holders (with or without an identifier)
- (iii) Except local buses
- (iv) Except for access to off-street premises.

"Except local buses" is the same legend as diagram 954.2, although diagram 620 allows the addition of times, days and months, whereas diagram 954.2 does not. "Except permit holders" would be appropriate for school buses and other buses entitled to use the route. To aid enforcement, an identification code could be displayed in a prominent position on the vehicle. "Except for access to off-street premises" might apply to a bus garage on the road where it is desirable to keep the number of vehicles to a minimum by prohibiting buses not using the garage.

PROHIBITION OF GOODS VEHICLES (OTHER THAN STRUCTURAL WEIGHT LIMIT)

5.15 The sign to diagram 622.1A is used to give effect to an order prohibiting goods vehicles with a plated maximum gross weight exceeding that shown on the sign (indicated in tonnes). The restriction applies to such vehicles even if they are unladen or they are the towing tractors of articulated vehicles and in these conditions their weight is below that shown on the sign. This sign is used when goods vehicles are prohibited for environmental reasons, e.g. where roads are narrow and unsuitable for large vehicles, or to protect residents from the nuisance caused by lorries in residential streets. The sign is not used for structural limits, such as those to protect weak bridges (see paras 5.31 to 5.33).

5.16 The sign to diagram 622.1A may indicate 7.5 or 18 tonnes. 7.5 tonnes is the more common weight limit to be signed as this includes all heavy goods vehicles with the rear red and yellow markings (including LONG VEHICLE). This aids vehicle recognition for enforcement purposes. The larger vehicle of 18 tonnes is one of the sizes included in the Departmental Standard BD 21/01 "The Assessment of Highway Bridges and Structures" (see para 1.3) and is the heaviest rigid vehicle that may be driven on two axles, again making recognition and enforcement easier.

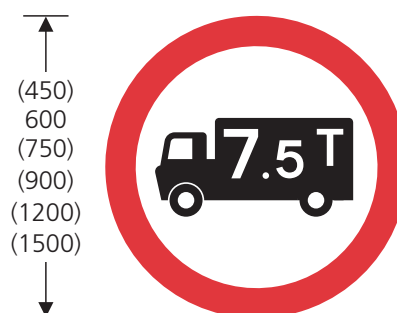

622.1A Prohibition of goods vehicles exceeding the maximum gross weight indicated

"7.5T" may be varied to "18T". May be used with diagram 554.3 or 620

5.17 As this is an environmental weight limit there may be exceptions, in which case a plate to diagram 620 would be used with diagram 622.1A. The appropriate permitted variants of diagram 620 are:

- (i) Except for access
- (ii) Except for loading
- (iii) Except for access to off-street premises.

Times, days and months may be added to the plate where the lorry ban does not apply at all times or where the exceptions apply only at certain times and not for the full duration of the prohibition.

5.18 Where a road is prone to ice or snowdrifts during most winters, an order can be made to prohibit goods vehicles for safety reasons when traffic signs are displayed. In this case the sign to diagram 622.1A should be supplemented by the "Ice" plate to diagram 554.3, varied to "Snowdrifts" if appropriate (see Chapter 4, paras 11.7 and 11.8).

5.19 The sign to diagram 622.2 is used to indicate the termination of the restriction signed by diagram 622.1A. There is no specific requirement to provide end of restriction signs and they would have little value where there are no exceptions to the goods vehicle prohibition. However, where there are exceptions, for example to allow loading, it is helpful to the driver to know where the restriction ends and hence where it becomes lawful to park the vehicle in an appropriate place (for purposes other than loading) without contravening the order.

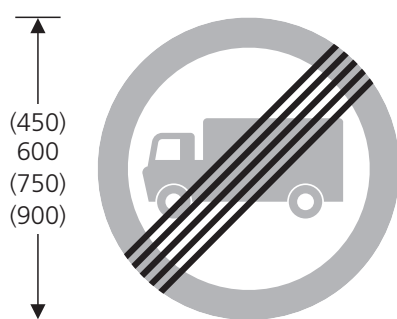

622.2 End of prohibition of goods vehicles

PROHIBITION OF ARTICULATED OR TRACK LAYING VEHICLES

5.20 The sign to diagram 622.4 gives effect to an order prohibiting articulated (see regulation 4) or track laying vehicles from a length of road, the legend reading “No articulated vehicles” or “No track laying vehicles” as appropriate. The signs would be used where, because of their physical nature, roads are not suitable for such vehicles. It is therefore a physical limit rather than an

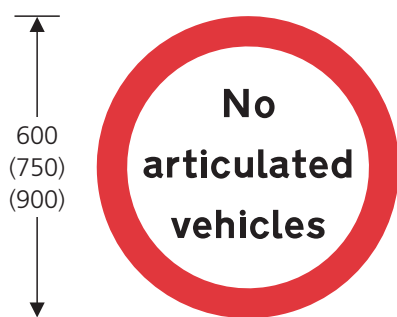

622.4 Articulated vehicles prohibited

“No articulated vehicles” may be varied to “No track laying vehicles”. May be used with diagram 554.3

environmental limit and for this reason the Directions do not allow a supplementary exception plate to be used with the sign. The only plate that may be used is the “Ice” plate to diagram 554.3 (see Chapter 4, paras 11.7 and 11.8).

PROHIBITION OF HORSE-DRAWN VEHICLES AND ACCOMPANIED HORSES

5.21 The sign to diagram 622.5 is used to give effect to an order prohibiting horse-drawn vehicles. It is likely to be used in areas where such vehicles operate and would apply to roads that are unsuitable for them or where they could themselves create a hazard to other road users.

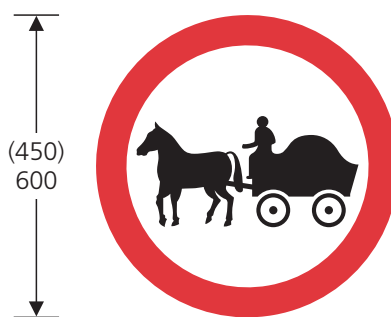

622.5 Horse-drawn vehicles prohibited

May be used with diagram 620

5.22 The sign to diagram 622.6 is likely to be used to indicate a byelaw prohibiting horses, both ridden and accompanied. It might be used to protect a route intended for use by pedestrians and cyclists only.

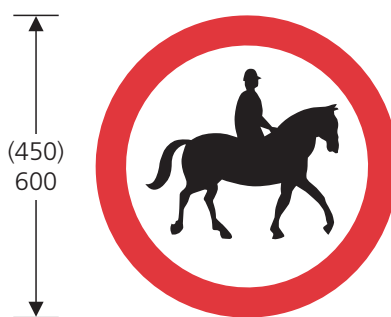

622.6 Ridden or accompanied horses prohibited

May be used with diagram 620

5.23 Where appropriate, the signs may be accompanied by the supplementary plate to diagram 620 (Except for access).



PROHIBITION OF TOWED CARAVANS

5.24 The sign to diagram 622.7 is used to give effect to an order prohibiting towed caravans. This might be used at difficult hills or narrow roads where an alternative route is available. It could also be used to protect unsuitable roads (e.g. narrow village streets or residential areas) close to a touring caravan site. If appropriate, the plate to diagram 620 (Except for access) may be used.

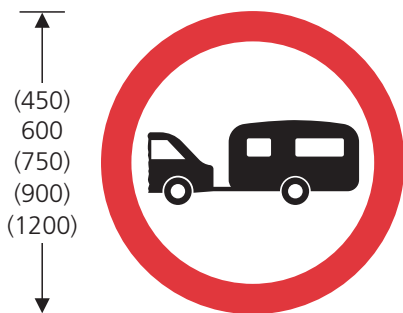

622.7 Towed caravans prohibited

May be used with diagram 620

PROHIBITION OF VEHICLES CARRYING EXPLOSIVES

5.25 The sign to diagram 622.8 is used to give effect to an order that prohibits vehicles carrying explosives from using a length of road. This might

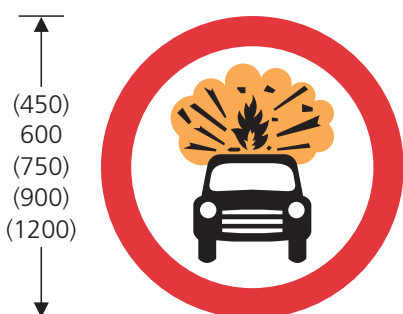

622.8 Vehicles carrying explosives prohibited

May be used only in combination with diagram 622.9. May also be used with diagram 620

622.9 No explosives

May be used only in combination with diagram 622.8. "No explosives" may be varied to "No inflammables or explosives"

be used at tunnels where the danger from such vehicles is likely to be greater or perhaps in urban or residential areas close to premises where explosives are manufactured. The need for the signs, other than at tunnels, is likely to be in areas known to have regular movement of explosives or inflammable materials. The sign must be accompanied by a plate to diagram 622.9 indicating either "No explosives" or "No inflammables or explosives". The plate to diagram 620 (Except for access) may be used where appropriate.

PROHIBITION OF CYCLING

5.26 The sign to diagram 951 is used to give effect to a prohibition of cycling made under an order, or, more often, imposed by a byelaw. It is mainly used where there are pedestrian routes through housing estates which are not suitable for cycling because either their width or the visibility along them is not sufficient. In order to make such areas more accessible, local authorities are encouraged to provide suitable facilities for cyclists (see section 17 for the signing of cycle facilities). The sign to diagram 951 should not be used to indicate the end of a shared pedestrian and cycle facility (see para 17.36).

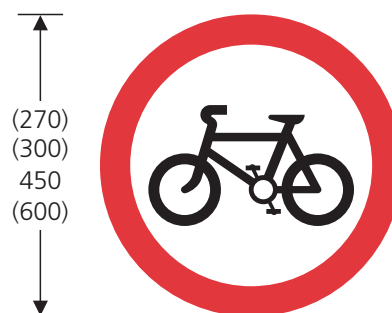

951 Riding of pedal cycles prohibited

PROHIBITION OF PEDESTRIANS

5.27 The sign to diagram 625.1 is used to give effect to an order to prohibit pedestrians. It is likely to be used in urban areas where inner ring roads etc. do not have any frontage development or footways, especially where such roads include flyovers and underpasses. The sign might also be appropriate where pedestrians are able to gain access to a tram-only route.

5.28 The Motorways Traffic (England and Wales) Regulations 1982 prohibit pedestrians from motorways and the sign to diagram 2901 is used to give effect to those Regulations. The sign to diagram 625.1 should not be used for this purpose.



625.1 Pedestrians prohibited

PROHIBITION OF TRAFFIC ON MOWN VERGE

5.29 Traffic, including pedestrians and animals, may be prohibited from using verges that are maintained in mown or ornamental condition. The sign to diagram 651 will always indicate that motor vehicles and cycles are prohibited. It may indicate that animals or pedestrians or both are also prohibited. The various layouts are shown on working drawing P 651 (see para 1.9).

5.30 A sign facing oncoming traffic should be provided at the start of the mown verge and after every road junction on the same side of the road to which the restriction applies. Signs should also be provided where traffic can enter from a junction on the opposite side of the road. For very long verges it may be desirable to provide repeater signs. The prescribed size of sign varies from 20 mm minimum to 40 mm maximum x-height. It is recommended that the largest size is used on roads where the 85th percentile speed is in excess of 40 mph. Intermediate signs may have a smaller x-height. For roads where



651 Prohibition of traffic on mown verge

An arrow may be added, pointing horizontally to the left or to the right. The word "animals", or the diagram 625.1 symbol together with the word "pedestrians", or both words and the diagram 625.1 symbol may be omitted

the 85th percentile speed is less than 30 mph, a 20 mm x-height should be sufficient for all signs.

STRUCTURAL WEIGHT LIMIT

5.31 Paras 5.15 to 5.19 give details of signs used to prohibit goods vehicles for environmental reasons. The weight limit prohibition sign to diagram 626.2A indicates a structural limit and applies to all types of vehicle, including buses. The sign is used to give effect to an order prohibiting a vehicle above the maximum gross weight specified on the sign from driving on a weak bridge. When the legend in the upper panel is varied to read "WEAK ROAD", it is used where an order has been made because the condition of a road is such that its use by heavy vehicles is liable to damage it.

5.32 The sign may indicate weights of 3T, 7.5T, 10T, 13T, 18T, 26T and 33T; these correlate to the classification divisions in Departmental Standard BD 21/01 "The Assessment of Highway Bridges and Structures" (see para 1.3).

5.33 Specifying gross vehicle weights makes enforcement simpler as it is necessary only to check the vehicle's plated weight against that on the sign, eliminating the need for a vehicle to be taken to a weighbridge for checking. Where an assessment shows that a structure can carry any unladen vehicle, and this has been allowed for in the order, the sign to diagram 626.2A may incorporate, as a bottom panel, the sign to diagram 627.1 (Except empty vehicles).

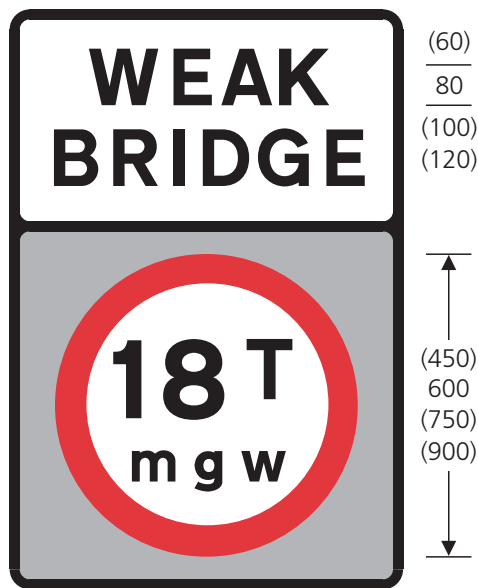

626.2A Maximum weight of vehicle on bridge

"18T" may be varied to "3T", "7.5T", "10T", "13T", "26T" or "33T". "BRIDGE" may be varied to "ROAD"



627.1 Exemption for unladen vehicles

May be used only in combination with diagram 626.2A

WIDTH AND LENGTH LIMITS

5.34 The sign to diagram 629 is used to give effect to an order prohibiting all vehicles exceeding the indicated width from being driven along a road. The order may be imposed to prevent entry to roads physically incapable of accommodating larger vehicles or to protect the environment by preventing unnecessary intrusion by large vehicles. In the latter case a physical feature might need to be installed to enforce it. Provision might be needed to permit buses to use the road and also to permit access. Where buses are excluded from an environmental width or

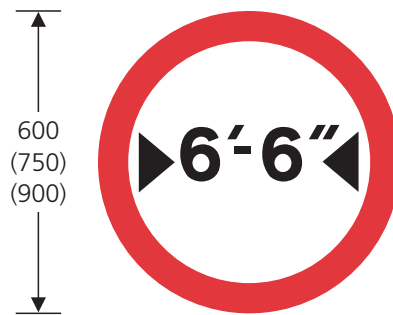

629 Width restriction

May be used with diagram 554.3, 620, 954 or 954.2

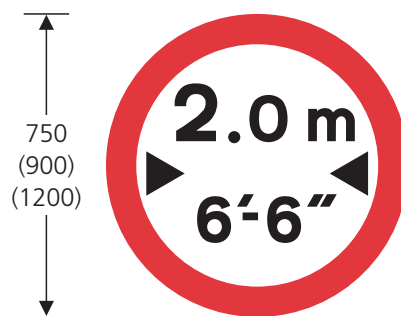

629A Width restriction in metric and imperial units

May be used with diagram 554.3, 620, 954 or 954.2

length limit, it might sometimes be preferable to impose a lorry ban with signs to diagram 622.1A (see paras 5.15 to 5.19) unless there are other large vehicles that are to be prohibited from using the road.

5.35 The maximum width permitted, in imperial units, should be 6 inches less than the narrowest part of the road, rounded to the nearest 6 inches downwards. If this narrow part is long and not straight it might be necessary to increase the clearance to allow for long vehicle overhang at bends. If the limit is introduced for environmental reasons, a width of 6 ft 6 in is frequently used, as this excludes most lorries.

5.36 The sign to diagram 629A is a combined metric and imperial version of the width limit sign. In order to maintain equivalent legibility, it is one step larger in size than diagram 629 (see Appendix A). It may be used in place of the imperial-only version, but metric units alone must not be used. It is recommended that

this sign is used in preference to the sign to diagram 629. The metric dimension should be obtained by measuring the narrowest part of the road in metres to two decimal places, subtracting 0.15 metres and deleting the second decimal digit.

5.37 The sign to diagram 629.1 is used to give effect to an order prohibiting vehicles exceeding the indicated length from being driven along a road. The order may be imposed to prevent entry to roads that are unsuitable for long vehicles or to protect the environment. In the latter case, a length limit might be preferable to a weight limit (see paras 5.15 to 5.19) as this can be more flexible in targeting a specific group of vehicles than the weight limits of either 7.5 tonnes or 18 tonnes that can be shown on the sign to diagram 622.1A. The length limit sign applies to all long vehicles, not only goods vehicles.

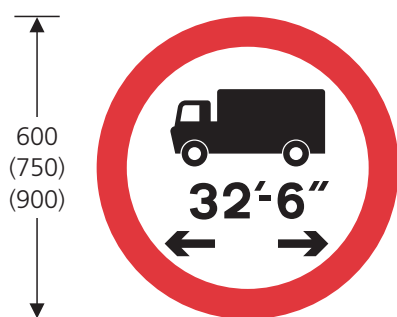

629.1 Length restriction

May be used with diagram 554.3, 620, 954 or 954.2

5.38 The vehicle length (in feet and inches) to be shown on the sign to diagram 629.1 will depend on any physical constraints along the road, particularly sharp bends, or, in the case of an environmental limit, the size of vehicle to be prohibited. Metric units may be substituted for imperial (see working drawing P 629.1), but the sign must then be used alongside one displaying imperial units only (Schedule 16, item 2). It is recommended that both the imperial and metric sign should be used wherever practicable. The metric dimension is obtained by converting the imperial dimension to metres and deleting the second and any subsequent decimal digit.

5.39 Where a width or length limit has been imposed for environmental reasons, the order may provide an exception for access to premises and land adjacent to the road, in which case the supplementary plate to diagram 620 (Except for

access) should be mounted below the sign. Exceptions may also be made for buses (diagram 954) or local buses (diagram 954.2). The permitted variants of diagram 620 that might be appropriate for an environmental width or length restriction are:

- (i) Except for access
- (ii) Except for loading
- (iii) Except permit holders (with or without an identifier)
- (iv) Except buses (same as diagram 954)
- (v) Except local buses (same as diagram 954.2)
- (vi) Except for access to off-street premises.

The above exceptions may be combined as appropriate, but (i) is not used with either (ii) or (vi), and (iv) is not used with (v). Times, days and months may be added to the diagram 620 plate where the restriction does not apply for 24 hours and for every day of the year or where the exceptions apply at different times to the main order.

5.40 Where the exceptions described in para 5.39 apply only to one section of the road and it is not physically possible to accommodate wide or long vehicles beyond the point where access is permitted, additional signs to diagram 629, 629A or 629.1 (without exception plates) should be provided. These should be located in accordance with the order. This would normally be immediately after the last available access point to premises or the last place where vehicles are able to turn round.

5.41 Where a road is prone to ice or snowdrifts during most winters, an order can be made to prohibit vehicles over a certain width or length when traffic signs are displayed. In this case the signs to diagram 629, 629A or 629.1 should be supplemented by the "Ice" plate to diagram 554.3, varied to "Snowdrifts" if appropriate (see Chapter 4, paras 11.7 and 11.8).

HEIGHT LIMIT

5.42 Signs to either diagram 629.2 (imperial units) or 629.2A (imperial and metric units) prohibiting vehicles above a certain height are used mainly at non-arch bridges and other structures with a

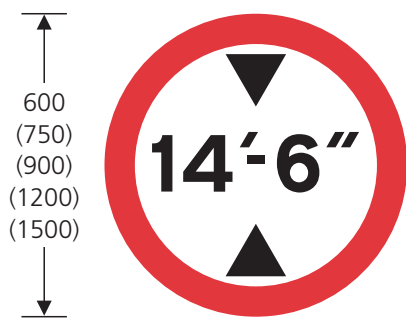

629.2 Height restriction

May be used with diagram 530.2

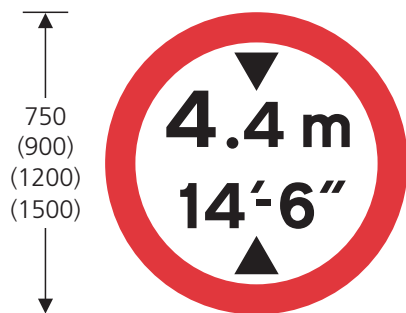

629.2A Height restriction in metric and imperial units

May be used with diagram 530.2

headroom less than 16'-6" (5.03 m), as they can give more effective protection than warning signs. In such circumstances they can be provided without the need to make a traffic regulation order (direction 7(3)). These signs should not be used at arch bridges, as the main risk to these is from vehicles which, although low enough to pass through the central part of the arch, might strike the curved shoulder of the structure. It is recommended that the sign to diagram 629.2A is used in preference to the imperial-only sign, but in order to maintain equivalent legibility, it is one step larger in size than diagram 629.2 (see Appendix A). Further guidance on the use of mandatory height limit signs at bridges, including height calculation and diversion route signing, can be found in Chapter 4, section 7.

5.43 Signs to diagram 629.2 or 629.2A may be used elsewhere to give effect to an order, but note that exception plates cannot be used with these signs. Care must be taken in deciding which lengths of road

are to be covered by the order, to ensure that access to premises is not affected. Where headroom is restricted by overhead cables, such as at a level crossing on an electrified railway or tramway, warning signs to diagram 779 with a supplementary plate to diagram 780A, 780.1A or 780.2A should be used (see Chapter 4, paras 21.9 to 21.12).

SITING OF SIGNS

5.44 Direction 8 sets out the requirements for the siting of signs that indicate the beginning of a restriction, requirement, prohibition or speed limit (see para 1.19). These requirements apply to all signs in this section, other than diagram 651 (prohibition of traffic on a mown verge; see paras 5.29 and 5.30). In general, the signs must be erected on each side of a single carriageway road or on each side of the carriageway in the direction of travel on a dual carriageway road. However, on a single carriageway road one sign only is required, together with any appropriate supplementary plate, if any of the following apply:

- (i) the restriction applies only to one side of the road. This could apply to the pedestrian prohibited sign (diagram 625.1) where there is a footway on one side of the road only and pedestrians are prohibited from using the verge on the other side.
- (ii) the restriction commences on a side road at a junction where the main road is one way. The sign should be sited and orientated so as to be clearly visible to traffic turning into the side road. Normally it would be located on the right hand side of the road where traffic turns left into that road and on the left hand side where traffic turns right.
- (iii) the restriction commences on a side road at a junction where the main road is two way, the side road has a carriageway width less than 5 m and the centre of the sign is within 2 m of the edge of the carriageway. Again, the sign should be sited so as to be clearly visible to traffic turning into the side road, from whatever direction.

6 PROHIBITION OF WAITING AND LOADING

GENERAL

6.1 Management of road space, in respect of stationary vehicles, comprises either negative or permissive controls both of which can apply to the carriageway, footway and verge. Negative controls prohibit waiting and loading, and generally use yellow signs and markings (but see para 6.3). Permissive controls provide on-street parking places and loading bays, and use white signs and markings. This section deals with signs for negative controls. Signs for permissive controls, including those combined with waiting and loading prohibitions, are covered in section 7. Section 9 covers the more restrictive “no stopping” orders, except red routes which can be found in section 10. For zonal controls see section 11 (Pedestrian Zones), section 12 (Controlled Parking Zones) and section 13 (Restricted Zones).

6.2 Waiting and loading prohibitions on the side of a road generally apply from the carriageway centre line to the highway boundary. The prohibition therefore applies to any verge, footway or cycle track as well as to the carriageway.

6.3 Standard exemptions to a waiting prohibition are not shown on the signs. These exemptions include stopping to pick up or set down passengers, and causing a vehicle to be stationary for the purposes of loading or unloading goods from that vehicle. Loading generally refers to commercial loading or to objects that are too heavy or bulky to be carried very far by hand, but does not include time for purchasing the goods. Where loading is not permitted, additional signs are provided. These have a white background, to contrast with the yellow “no waiting” signs. Disabled badge holders are permitted to park for up to three hours where there is a waiting, but not a loading prohibition. Where a length of road is not suitable for parking by disabled badge holders, a prohibition of loading should be considered. However, if a loading provision is necessary, a loading bay should be provided as this cannot be used by disabled badge holders (see paras 7.27 to 7.29). A prohibition of loading still permits drivers to pick up and set down passengers.

6.4 Road markings comprise continuous yellow lines for waiting prohibitions and yellow kerb marks for a loading prohibition. Further details are given in Chapter 5, section 20 (see para 20.3 in Chapter 5 in respect of the use of transverse marks on yellow lines). The tables below the signs illustrated in this

section indicate the appropriate road markings, if any, that are to be used in conjunction with the upright signs.

6.5 For sign design, size and siting see paras 6.31 to 6.37. Details of the correct design for most permitted variants are shown on the working drawings (see para 1.9). Reference should always be made to these.

PROHIBITION OF WAITING AT ANY TIME

6.6 As the double yellow line to diagram 1018.1 means no waiting at any time for a period not less than four consecutive months, signs are no longer prescribed for a prohibition of waiting that is in force for 24 hours a day, every day of the year. This restriction is now imposed solely by the road markings. Where signs to the former diagram 637 (no waiting at any time) prescribed by the Traffic Signs Regulations and General Directions 1994 are still in place there is currently no time limit for their removal. However, they cannot be replaced if they become worn, damaged or go missing. There are other signs which may be varied to indicate no waiting at any time, but only in the circumstances described below (see also table 6-1). Where there is also a loading prohibition, the sign to diagram 638 is used for a 24-hour prohibition and the sign to diagram 638.1 for a prohibition that applies for only part of the day. These signs must be accompanied by the kerb marks to diagram 1020.1 or 1019 as indicated in table 6-2.

6.7 The sign to diagram 637.3 is used where a prohibition of waiting at any time applies for a period less than 12 months of the year, but for at least four consecutive months. Such a prohibition is likely to be imposed where there is seasonal traffic, for example at a holiday resort. The sign is used with the double yellow line to diagram 1018.1. The Regulations do not allow the date to be omitted in order to replicate the sign to diagram 637 described in para 6.6, nor should the date be varied to a twelve month period. If there is also a loading prohibition, the sign to diagram 640 is used, with the upper panel varied to diagram 637.3. If the loading prohibition applies for 24 hours each day and for a period of at least four consecutive months, the double kerb marks to diagram 1020.1 are used, otherwise the single kerb mark to diagram 1019 should be used.

6.8 Where the “no waiting at any time” prohibition applies to a period of less than four consecutive months in the year or less than seven days a week, the sign to diagram 639 is used. This is varied to “At any time”, with the addition of the period or days of the week as appropriate. Diagram 639 is used with the single yellow line (diagram 1017) and never with the double yellow line (diagram 1018.1). Where there is also a loading prohibition, the combined sign shown in diagram 640 is used, varied as appropriate. The corresponding road markings will be the single yellow line (diagram 1017) and the single kerb mark (diagram 1019). Double kerb marks (diagram 1020.1) would not normally be used because the loading prohibition is unlikely to apply for 24 hours each day and for a period of at least four consecutive months, as this would be a longer period than that for the waiting prohibition.



637.3 Continuous prohibition of waiting for at least four consecutive months

Permitted variants	An arrow may be added pointing to the left or to the right. “1 May-30 Sept” may be varied to any period of not less than four consecutive months.
Road markings	1018.1



638 Continuous prohibition of loading and unloading

Permitted variants	An arrow may be added pointing to the left or to the right.
Road markings	1020.1

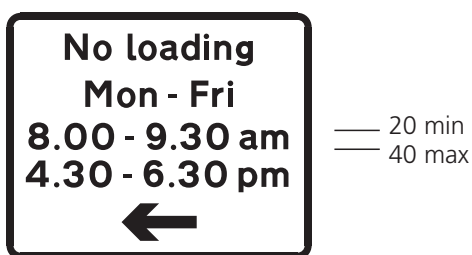

638.1 Prohibition of loading and unloading during the periods shown

Permitted variants	The arrow may be reversed or omitted. The time periods may be varied and dates may be added.
Road markings	1020.1 when indicating a period of at least four consecutive months. 1019 for any other period. (See table 6-2)

Table 6-1 Examples of the use of “no waiting at any time” plates

Waiting restriction	Sign diagram no.	Road marking diagram no.
At any time	None used	1018.1
At any time 1 May - 30 Sept	637.3	1018.1
At any time 1 Jul - 31 Aug	639	1017
At any time Mon - Sat	639	1017

Table 6-2 Examples of the use of road markings with loading restriction plates

Loading restriction	Sign diagram no.	Road marking diagram no.
At any time	638	1020.1
At any time 1 May - 30 Sept	638.1	1020.1
At any time 1 Jul - 31 Aug	638.1	1019
At any time Mon - Sat	638.1	1019
Any period less than 24 hrs	638.1	1019

PROHIBITION OF WAITING FOR LESS THAN 24 HOURS

6.9 When the prohibition of waiting applies for a period less than 24 hours each day, diagram 639 is used, with the appropriate times displayed. The sign may be varied to include dates if the prohibition does not apply all year round. The associated marking is always the single yellow line to diagram 1017. Where a prohibition of loading also applies, the combined sign to diagram 640 is used, together with the single yellow line and the single kerb mark (diagram 1019).



639 Prohibition of waiting during the period indicated

Permitted variants	The arrow may be reversed or omitted. The time period may be varied and a date may be added.
Road markings	1017

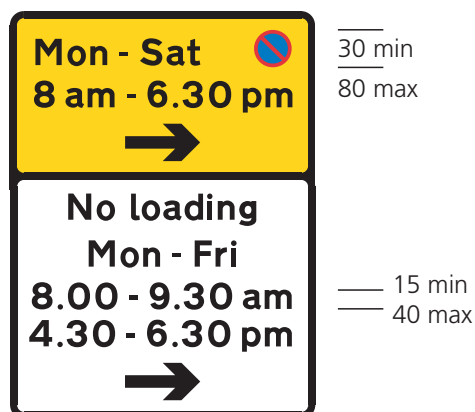

640 Prohibition of waiting and of loading and unloading during the periods indicated

Permitted variants	One or both of the arrows may be reversed or omitted. The time periods may be varied and dates may be added. The upper panel may be varied to diagram 637.3 or 650.3. The lower panel may be varied to diagram 638 (see figure 6-3).
Road markings	As for diagrams 637.3, 639 and 638.1. Additionally 1028.2 when upper panel is varied to diagram 650.3 (see para 6.14).

PROHIBITION OF WAITING ON VERGE OR FOOTWAY

6.10 As described in para 6.2, a prohibition of waiting extends from the centre of the road to the highway boundary. However, there might be certain situations where it is required to prohibit waiting on the verge or footway, but not on the main carriageway. This is most likely on rural roads subject to an order that prohibits stopping on the main carriageway (i.e. a 24-hour rural clearway; see paras 9.3 to 9.8). It might be desirable to prevent waiting on a verge because the ground is soft or newly seeded, or perhaps for road safety or security reasons, such as near an airfield. In this case, the sign to diagram 637.1 is used, with no road markings. It may indicate "verge", "footway" or both, and the "no waiting" symbol may be varied to the "no stopping" symbol shown in diagram 642. The latter applies where the order prohibits stopping rather than waiting.



637.1 Continuous prohibition of waiting on verge or footway

Permitted variants	An arrow may be added pointing to the left or to the right. The sign shown in diagram 642 may be substituted for the symbol. The words "verge or" or "or footway" may be omitted.
Road markings	None

6.11 In London, parking on the footway or verge is unlawful unless authorised by a resolution of the local authority under section 15(4) of the Greater London Council (General Powers) Act 1974 and indicated by the appropriate signs and markings (see section 8). Elsewhere in urban areas, orders are required to prohibit verge and footway parking. In many cases the use of the sign to diagram 637.1 is not appropriate and therefore new zonal signs are being developed to inform drivers that they are entering an area where parking on the verge and footway is prohibited. These signs require authorisation (see para 2.1) and local authorities wishing to implement such a scheme should enter into discussions with the Department at an early stage.

NO WAITING EXCEPT TAXIS, AMBULANCES OR POLICE VEHICLES

6.12 At a taxi rank, other vehicles may be prohibited from either waiting or stopping (see paras 9.25 to 9.32 for “no stopping” signs). Two “no waiting” signs are prescribed. The sign to diagram 650.2 is used where the prohibition of waiting and the operation of the taxi rank apply during the same time period. The sign to diagram 650.3 is used where the exception for taxis applies only for part of the period that waiting is prohibited. Where the periods of operation for the taxi rank and the prohibition of waiting are not continuous, separate signs to diagrams 639 and 650.2 should be used; for example, where the taxi rank operates overnight from 11 pm to 5 am and the waiting prohibition applies from 8 am to 6 pm.

6.13 The sign to diagram 650.2 does not prohibit loading. Where it is required to prohibit loading, a “no stopping” taxi rank should be provided, with a sign to diagram 650.1 (see paras 9.25 to 9.32). As the sign to diagram 650.3 indicates a waiting prohibition that extends beyond the operational period of the taxi rank, it may be used as the upper panel to the sign to diagram 640 when a loading prohibition also applies.

6.14 The road marking for a taxi rank is the yellow bay to diagram 1028.2 (see Chapter 5, para 20.12). This is used even when the upright sign is to diagram 640. Where waiting restrictions apply outside the hours of operation of the taxi rank, the single yellow line to diagram 1017 is used within the bay marking. This does not apply to the sign to diagram 650.2



650.2 Prohibition of waiting by vehicles other than taxis during the period indicated

Permitted variants	An arrow may be added pointing to the left or to the right. The time period may be varied or omitted; a date may be added. “taxis” may be varied to “ambulances” or “police vehicles”.
Road markings	1028.2



650.3 Continuous prohibition of waiting by vehicles with an exemption for taxis during the period indicated

Permitted variants	An arrow may be added pointing to the left or to the right. “At any time” and the time period may be varied, and a date may be added. “taxis” may be varied to “ambulances” or “police vehicles”.
Road markings	1028.2 and either 1017 or 1018.1

unless accompanied by the sign to diagram 639 (see para 6.12). The double yellow line to diagram 1018.1 is used with diagram 650.3 when waiting is prohibited at all times, except for taxis during the specified hours. Where the taxi rank operates at all times, the appropriate sign is diagram 650.2, with the time period omitted. In this case, no yellow lines are used within the bay marking. Where there is a prohibition of loading and the sign to diagram 650.3 forms the upper part of diagram 640, single or

double kerb marks to diagram 1019 or 1020.1 respectively are provided as appropriate. Figure 6-1 shows various examples of signing and marking taxi ranks.

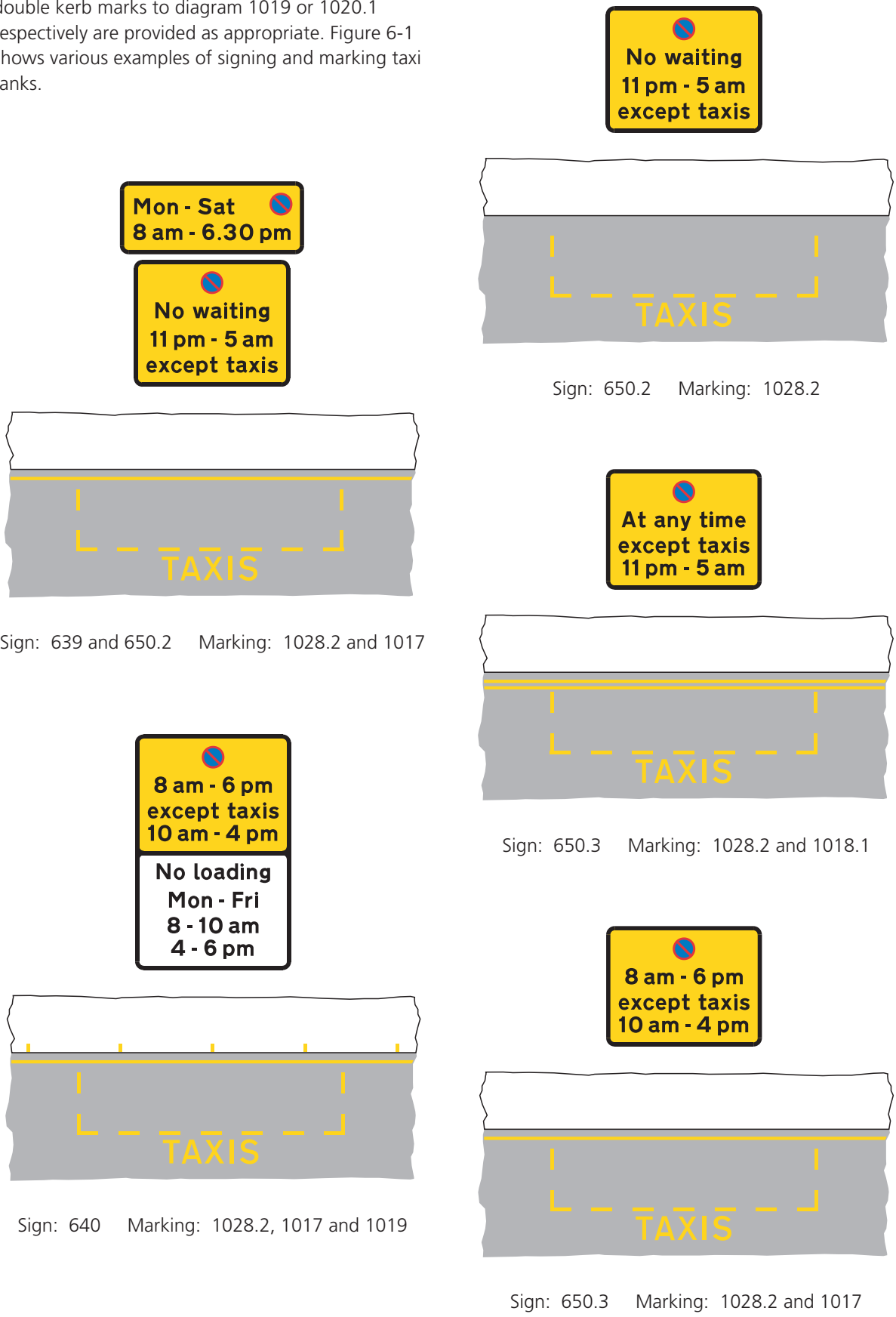

Figure 6-1 Examples of taxi rank signing and marking

6.15 Where a taxi rank is used for other purposes, such as a loading bay, during times when the rank is not operational, the sign to diagram 639.1B is used. The upper panel is varied to either diagram 650.2 or 650.3 as shown in figure 6-2. See paras 7.30 to 7.32 for further details, including the appropriate bay markings.



Figure 6-2 Variant of diagram 639.1B indicating a loading bay that is used as an overnight taxi rank (see table 7-4 for road markings)

6.16 The informative sign to diagram 857.1 may be used to display fare tables and any additional information such as the number of taxis allowed to wait in the stand and the conditions of hire. As the sign is mainly for the information of customers, it should normally face onto the footway. Other mounting positions may be adopted, e.g. it may face the carriageway if the information relates to the way in which taxis may use the stand.

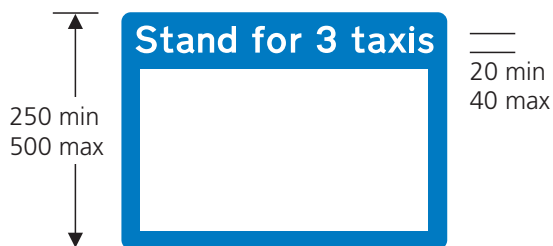

857.1 Information relating to a taxi rank

The number of taxis indicated may be varied. Information relating to taxi services may be shown in the white space in any colour of lettering not exceeding 25mm in height. The white space may be omitted (see working drawing P 857.1)

6.17 The Regulations allow the legend “taxis” on the signs to diagrams 650.2, 650.3 and 640 (when the upper panel is varied to diagram 650.3) to be varied to “ambulances” or “police vehicles”. Likewise the legend TAXIS forming part of the bay marking to diagram 1028.2 may be varied to AMBULANCES or POLICE. Paras 6.12 to 6.14 and figure 6-1 apply to these variations in the same way that they apply to taxi ranks.

PROHIBITION OF WAITING BY GOODS VEHICLES AND BUSES

6.18 The sign to diagram 640.2A gives effect to an order prohibiting waiting (but not loading) by any goods vehicle with a maximum gross weight of either 5 tonnes or 7.5 tonnes as indicated on the sign. The order may also refer to buses, either in addition to, or in place of goods vehicles. The bus

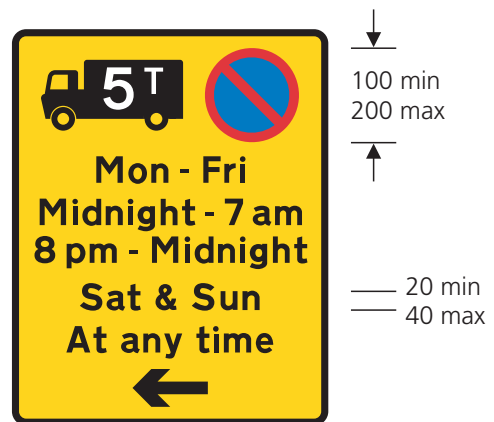

640.2A Prohibition of waiting by goods vehicles

Permitted variants	The arrow may be reversed or omitted. The time periods may be varied and dates may be added. “5T” may be varied to “7.5T”. The bus symbol shown in diagram 952 may be added below or substituted for the lorry symbol. The lorry and bus symbols shall face right when the arrow points to the right and the relative position of these symbols and the “no waiting” symbol shall be reversed (see working drawing P 640.2A).
Road markings	None

symbol from diagram 952 must then either be added to, or substituted for the lorry symbol. Restrictions are normally applied overnight and at weekends as an environmental measure.

6.19 The sign is used either as a repeater sign within a controlled parking zone that applies only to commercial vehicles (see paras 12.15 to 12.18) or as the only sign on roads not forming part of a zone. In both cases, road markings are not used and enforcement depends on the upright signs only. At the start or end of any restriction that is not within a zone, the sign should include an arrow indicating the length of road to which the restriction applies. On other signs the arrow is omitted. In a zone, the Regulations require that at least one sign is provided on each side of every road. For roads not within a zone, additional signs might be required as there is no zone entry sign. In this case, the aim should be to provide signs at approximately 60 m intervals on each side of the road.

6.20 Care must be taken to ensure that drivers do not associate the sign to diagram 640.2A with any yellow lines that relate to other waiting restrictions that might be imposed, particularly as these are likely to apply at different times. It is therefore recommended that the sign be co-located with the sign to diagram 639 or 640 as appropriate.

PROHIBITION OF WAITING IN OFF-HIGHWAY LOADING AREAS

6.21 The signs to diagrams 640.3, 640.4 and 640.5 are used to give effect to an order made under section 61 of the Road Traffic Regulation Act 1984 to control parking in off-highway goods vehicle loading areas.

6.22 As such areas are off-highway, the consent of the owners and occupiers of the loading area must be obtained before commencing the order-making procedure. It is also likely that the order will need to be enforced by the local authority and not the police.

6.23 The restriction is signed by upright signs alone and it is therefore preferable that orders are applied only to areas which have clearly defined boundaries.

6.24 The sign to diagram 640.3 should be erected at each entrance to an area to which an order applies and repeater signs to diagram 640.4 used in



640.3 Entrance to a designated off-highway loading area in which waiting restrictions apply

Permitted variants	The time period may be varied and a date may be added.
Road markings	None



640.4 Waiting prohibited in a designated off-highway loading area except by permitted vehicles

Permitted variants	The time period may be varied and a date may be added.
Road markings	None



640.5 End of a designated off-highway loading area in which waiting restrictions apply

Permitted variants	None
Road markings	None

larger areas as necessary. A sign to diagram 640.5 should be erected at each exit from the area, but if the area is small with a combined entrance and exit directly onto a public highway, this sign may be omitted.

6.25 These signs are not for use on the public highway. Loading bays on the highway should be signed using diagram 660.4 (or diagram 639.1B varied to incorporate diagram 660.4, see section 7) together with road markings to diagram 1028.3, 1032 or 1033.

TEMPORARY PROHIBITION OF WAITING AND LOADING

6.26 A temporary prohibition of waiting is indicated by signs to diagram 636. The sign may only be placed by a traffic authority if a temporary traffic regulation order has been made, or for up to seven days by the police in an emergency. The prohibition may temporarily revoke an existing order or impose an order where no order was previously in force.

6.27 The name of the traffic authority or police force responsible for the sign, or the word "Police" or "POLICE" may be added above or below the roundel. As the prohibition applies at all times that the sign is displayed, there is no permitted variant to allow the addition of a time period or the days of the week. An arrow may be added to indicate the start of the prohibition. This should be placed below the roundel. The yellow background does not have a prescribed shape as this depends on the method of mounting (see working drawing P 636). The yellow background does not have a border. The sign is prescribed in two sizes; 275 mm diameter for use on portable stands or trestles, and 200 mm, which is the maximum that will fit on a three-sided "cone". The sign must not be mounted on a curved surface.

6.28 The sign to diagram 636.1 is used to indicate a temporary prohibition of loading. Where there is a permanent 24-hour prohibition of waiting indicated by double yellow lines, the sign is used on its own. Otherwise there is likely to be a temporary prohibition of waiting and the "No loading" sign would be combined with the temporary "no waiting" sign as shown on working drawings P 636 and P 636.1 (see para 1.9).

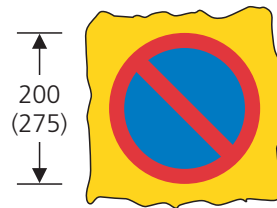

636 Temporary prohibition of waiting

Permitted variants	An arrow may be added pointing to the left or to the right. The name of the police force or traffic authority, or the word "Police" or "POLICE" may be added above or below the roundel.
Road markings	None



636.1 Temporary prohibition of loading and unloading

Permitted variants	The legend may be on one line.
Road markings	None

6.29 Yellow road markings are not used with these signs, although any existing markings (and signs) will of course be left in situ. However, if the temporary prohibition is likely to last for several months, consideration should be given to providing more permanent signs, together with appropriate road markings, in accordance with para 6.6. If the temporary prohibition applies for part of the day only (e.g. when works are in progress), signs and markings should be provided in accordance with para 6.9. Where it is not possible to provide road markings (e.g. because works are taking place on the carriageway), the temporary 24-hour prohibition signs to diagrams 636 and 636.1 should be used.

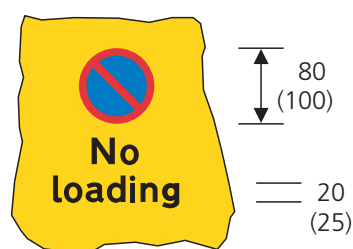

**640.1 Temporary suspension of parking
(Indication on parking meter cover)**

Permitted variants	“during meter control” may be added. “No loading” may be omitted.
Road markings	None

6.30 Where a parking meter is suspended, the sign to diagram 640.1 is used as a temporary cover. This may indicate a prohibition of waiting or a prohibition of both waiting and loading. Where the temporary prohibition applies only during the hours of operation of the parking meters within a meter zone, the legend “during meter control” is added. The words “No waiting” or “No unloading” are not prescribed and must not be used.

SIGN DESIGN, SIZE AND SITING

6.31 The detailed design of signs for waiting and loading restrictions is set out on the appropriate working drawings and in section 12 of Chapter 7. Where more than one sign is provided at the same location, they should not be merged into a single multi-panel sign unless this is prescribed by the Regulations, e.g. diagram 640. Where new traffic regulation orders are to be introduced, restrictions should be kept as simple as possible to avoid complex traffic signs that might be difficult for drivers to understand. For example, a prohibition that applies overnight every day of the week is simply signed as 10 pm - 6 am. If the prohibition did not apply on Sunday night and Monday morning, the signing would be more complex and potentially confusing; e.g. Monday 10 pm - Midnight; Tues - Sat Midnight - 6 am, 10 pm - Midnight; Sunday Midnight - 6 am.

6.32 A restriction always applies at all times unless qualified by an indication that it applies only at specific dates or times. It will lead to confusion, and

undermine understanding of restrictions signed according to this convention, if expressions like “Mon - Sun” are used. Similarly, restrictions apply on public holidays unless signs specifically indicate that they do not.

6.33 Single panel signs for a permanent prohibition of waiting and loading are generally prescribed with an x-height in the range 20 mm minimum to 40 mm maximum. The appropriate x-height is determined by the need to ensure conspicuity rather than by the speed of traffic. Therefore the smaller x-heights are more appropriate for signs with larger amounts of information. For this reason, the double-panelled sign to diagram 640 is prescribed with a minimum x-height of 15 mm. Choice of x-height will depend on prevailing conditions and the design of the sign. In a quiet narrow residential street, a 20 mm x-height is likely to be adequate even for the smallest signs (e.g. a sign to diagram 639 with the legend “8 am - 6 pm”). However, in a busy high street or a wide suburban road, a larger x-height such as 25 mm is likely to be appropriate, particularly if the sign does not have high target value. The largest size of 40 mm x-height is likely to be appropriate on urban dual carriageways or on other roads with a speed limit of 50 mph or more. This applies to the sign to diagram 637.1 (prohibition of waiting on the verge or footway) when used on a rural road subject to the national speed limit. Signs for off-highway loading areas (see paras 6.21 to 6.25) have a single size of 40 mm x-height (50 mm for the legend “Loading area” on diagram 640.3).

6.34 Signs, other than the “no waiting on verge or footway” sign to diagram 637.1 (see para 6.37), should be erected parallel to the kerb, facing the carriageway and sited at approximately 60 m intervals (on each side where the restriction applies to both sides of the road). This will normally be achieved by fixing the signs on every lamp column within the restricted length of road. Where there are no lamp columns or other suitable mounting points, posts will need to be erected. Providing conspicuity is not compromised, signs may be mounted at the back of the footway on posts, walls or railings. This is likely to be preferable where the footway is narrow. In environmentally sensitive areas where the post is sited at the back of the footway, consideration might be given to painting it a similar colour to the adjacent building (direction 41 allows a post to be any single colour, including its natural colour).

6.35 Signs should be erected within 15 m of the start and end of the prohibition. Where there is a change in the prohibition but no change in the road marking (i.e. seasonal double yellow line to a twelve month double yellow line, or a single yellow line where the time period changes), signs for each prohibition should be mounted either side by side or one above the other at the changeover point. Each sign should include an arrow indicating the direction in which the prohibition extends. The double or

single yellow line must have a transverse mark at the changeover point (see Chapter 5, para 20.3). If the loading prohibition does not change, the arrows should be applied to the waiting prohibition part of the sign. In this case, an alternative to providing two signs to diagram 640 would be to provide two signs to diagram 639 and one sign to diagram 638.1 (without an arrow). Figures 6-3 to 6-9 give examples of signing changeover points. Where there is more than one sign, they may be mounted on a grey backing board; this need not extend beyond the top and bottom of the assembly, or beyond the sides of the widest sign.

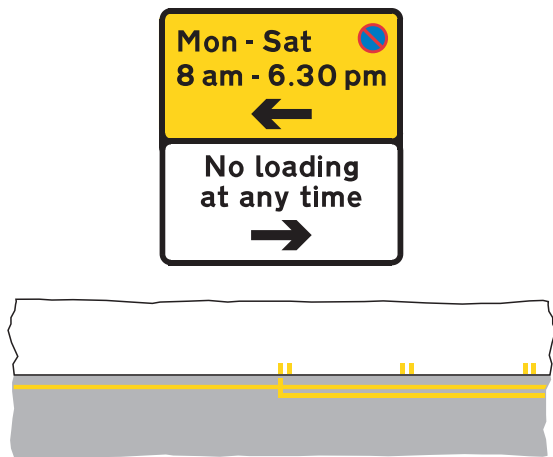

Figure 6-3 Change from day-time prohibition of waiting to both no waiting and no loading at any time



Figure 6-4 Change from seasonal no waiting at any time to all year round no waiting at any time

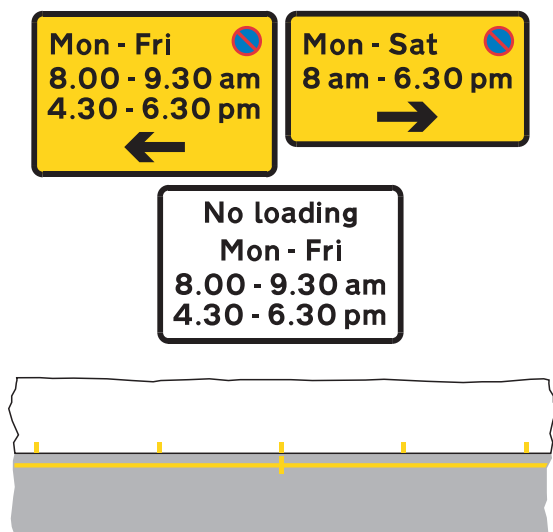

Figure 6-5 Change from peak-hour prohibition of waiting to day-time prohibition of waiting with no change to peak-hour prohibition of loading

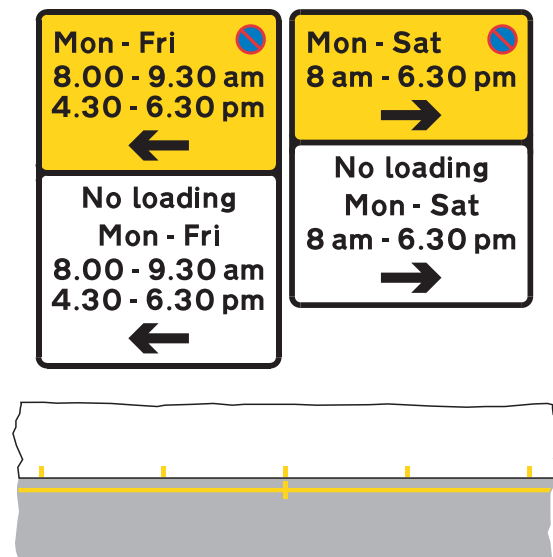

Figure 6-6 Change from peak-hour prohibition of waiting and loading to day-time prohibition of waiting and loading

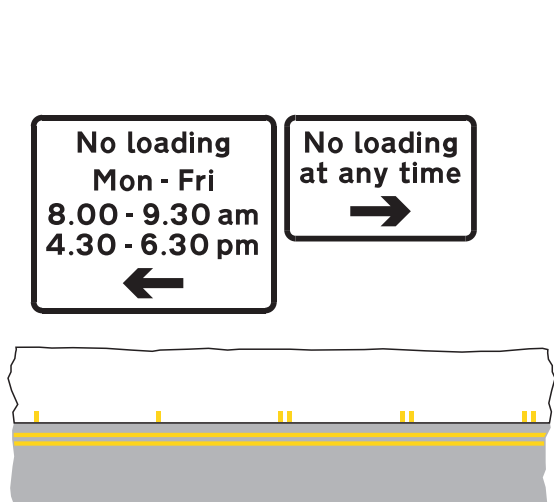

Figure 6-7 Prohibition of loading changes from peak-hour to at any time, with no change to prohibition of waiting at any time

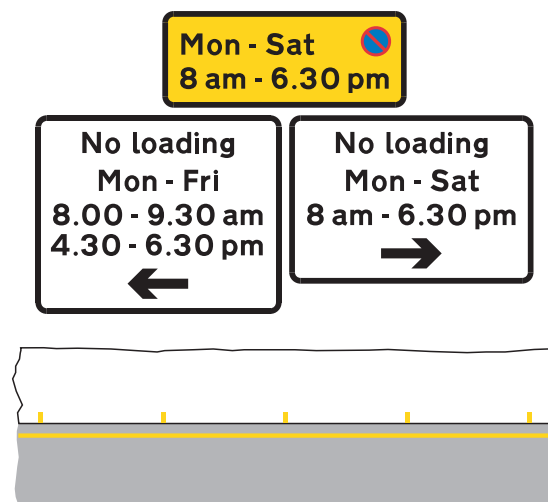

Figure 6-8 Change from peak-hour prohibition of loading to day-time prohibition of loading with no change to day-time prohibition of waiting

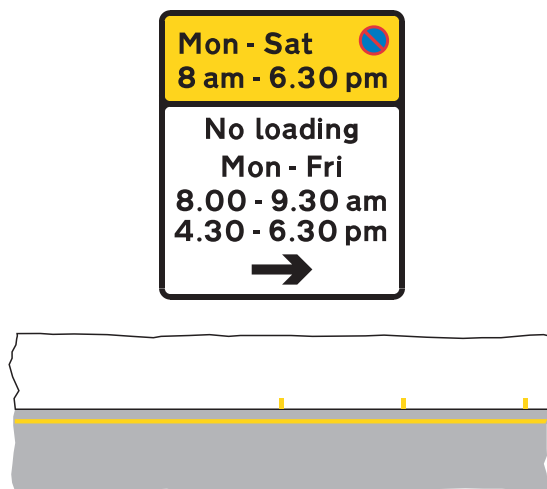

Figure 6-9 Start of peak-hour prohibition of loading with no change to day-time prohibition of waiting

6.36 Where a loading prohibition commences at a point where the waiting prohibition does not change, a sign to diagram 640, with an arrow in the lower panel only, should be erected. Where the loading prohibition changes, but the waiting prohibition does not, it is recommended that one sign to diagram 639, together with two signs to diagram 638.1 should be used. If the waiting prohibition applies at all times, then the only signs

used where a loading prohibition commences or changes will be those to diagrams 638 and 638.1 incorporating arrows. In the situations described in this paragraph, as the waiting prohibition does not change, the double or single yellow line will not have a transverse mark. See figures 6-7 to 6-9 for examples of signing. See Chapter 5, para 20.7 to 20.10 for details of the “no loading” kerb marks to diagrams 1019 and 1020.1.

6.37 The sign to diagram 637.1 (prohibition of waiting on the verge or footway, see para 6.10) is used without a road marking and therefore the first and last sign indicating where the prohibition starts and finishes should normally include an arrow. In village locations where a verge is being protected from parked vehicles, the start and end might be obvious and arrows might not be necessary.

Intermediate signs should be provided as appropriate. In most cases, including rural roads subject to the national speed limit, signs should be provided at approximately 30 m intervals. This spacing is the same as for waiting restriction signs in pedestrian zones (see para 11.19) and restricted zones (see para 13.8) where there are no yellow lines to draw attention to the prohibition.

7 ON-STREET PARKING AND LOADING

GENERAL

7.1 An on-street parking **place** is that part of the highway set aside for stationary vehicles. This might be an uncontrolled lay-by or parking area at the side of the main carriageway, or it might be part of a road (including a lay-by) subject to controls imposed by a traffic regulation order etc. A controlled parking place is usually indicated by a parking **bay** which is a defined area marked on the carriageway where vehicles should be parked. An exception might be where an entire road is designated as a parking place and entry signs indicate the restrictions that apply (see para 7.15). Parking bays are prescribed as diagrams 1028.3, 1028.4, 1032 and 1033 (see Chapter 5, section 20) and must be used only to indicate the effect of an order etc. (direction 7). A parking bay indicated by diagram 1032 or 1033 comprises individual parking **spaces** for single vehicles. Bay markings are always accompanied by upright signs, except for diagram 1028.4 when used for a motor cycle bay without any time limit (although a sign to diagram 801 with the plate to diagram 804.4 may be provided), and diagrams 1032 and 1033 when used in conjunction with parking meters. Bay markings are always white and upright signs (except diagram 801) have a white background. This indicates that permissive controls are in operation. Yellow markings and signs are used for negative controls (see section 6), although "No loading" signs are white (see para 6.3).

7.2 The provision of parking places (e.g. permit holder only bays) does not require the establishment of a controlled parking zone. On-street parking controls can apply to any road whether or not it is within a controlled zone. For guidance on the signing of controlled parking zones see section 12.

7.3 For sign design, size and siting see paras 7.45 to 7.52. Design details for most permitted variants are shown on the working drawings (see para 1.9). Reference should always be made to these.

GENERAL PARKING PLACES WITHOUT TIME LIMIT OR PAYMENT

7.4 The sign to diagram 801 is used as an informative sign, generally on a rural road, when indicating a lay-by or off-road parking area that has no restrictions and does not require the provision of a bay marking. A sign to diagram 2501 is normally used in advance of the lay-by or parking area.

7.5 Diagram 801 may be used in combination with a supplementary plate to diagram 804.1, 804.2, 804.3 or 804.4 to indicate a parking place reserved for goods vehicles, cars, caravans or solo motor cycles respectively. Where the parking place is for buses only, the sign to diagram 969 should be used. In each case an order will be required (direction 7) as the parking place is restricted to use by a particular class of vehicle. The signs do not have permitted variants and therefore they can be used only where the reserved parking place operates at all times.

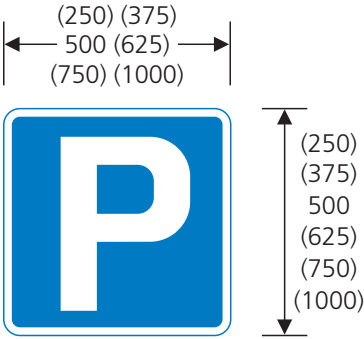

801 Parking place

May be used with diagram 804.1, 804.2, 804.3 or 804.4

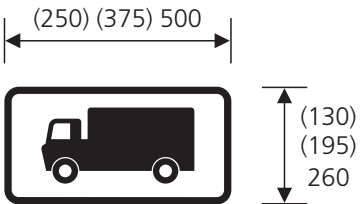

804.1 Parking place for goods vehicles

May be used only in combination with diagram 801

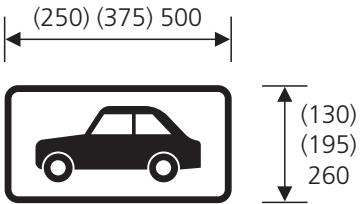

804.2 Parking place for motor cars

May be used only in combination with diagram 801

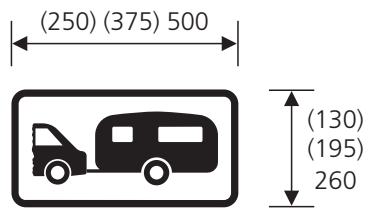

804.3 Parking place for caravans and motorised caravans

May be used only in combination with diagram 801

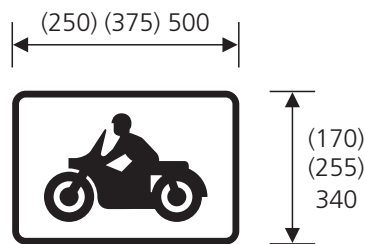

804.4 Parking place for solo motor cycles

May be used only in combination with diagram 801

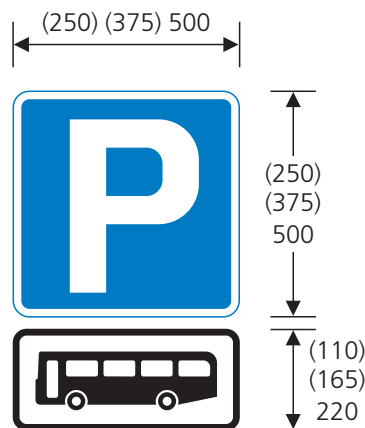

969 Parking place for buses

7.6 Bay markings are normally used with the above signs (see table 7-1), although there might be circumstances where such markings are not required, e.g. within a lay-by. The sign to diagram 801, when used without a supplementary plate, does not require an order, but any bay marking with which it is used does. It is unusual to provide such an arrangement along the side of a road, as although it

would indicate an area suitable for parking, it would otherwise have no more effect than if no signs or markings were provided at all. The situations where it would however be appropriate to make an order and use a bay marking with a sign to diagram 801 without a supplementary plate are:

- (i) where echelon parking along the side of a road is required and the marking to diagram 1033 is used
- (ii) in the centre of the carriageway where either diagram 1028.4 or 1033 would be used
- (iii) in a controlled parking zone to indicate areas where there are no parking restrictions (see section 12).

The motor cycle bay (diagram 1028.4 with the appropriate legend) may be used without an upright sign (see para 7.1).

Table 7-1 Bay markings used with signs to diagrams 801 and 969

Sign diagram no.	Road marking diagram no.
801	1028.4, 1032 or 1033, each with no legend
801 plus 804.1	1028.3 with no legend
801 plus 804.2	1028.4, 1032 or 1033, each with no legend
801 plus 804.3	1028.4 with no legend
801 plus 804.4	1028.4 with no legend, or with the legend SOLO MOTORCYCLES ONLY, SOLO M/CYCLES ONLY or SOLO M/CS ONLY
969	1028.3 with the legend BUSES

7.7 Signs for cycle parking places are shown in diagrams 968 and 968.1. These have no permitted variants, are not used with road markings and do not require an order. They are generally associated with cycle racks and storage facilities.

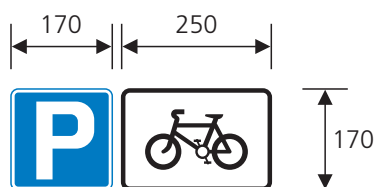

968 Parking place for pedal cycles

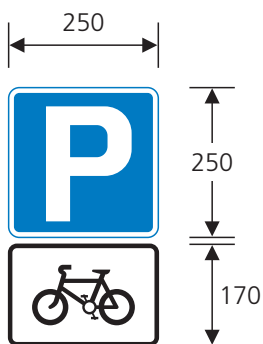

968.1 Parking place for pedal cycles

omitted where there is unlimited parking for a particular class of vehicle and times of operation are shown. Where the parking place operates at all times and there is no limit on waiting, a sign to diagram 801(with or without a supplementary plate) or 969 should be used as appropriate (see para 7.5).

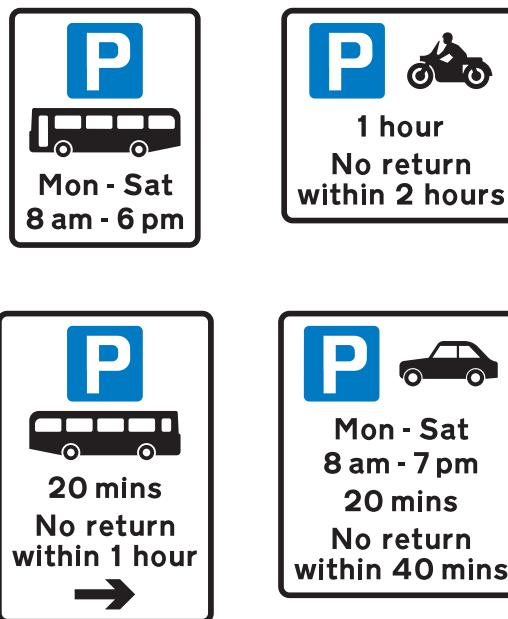

The car, motor cycle and bus symbol shall face to the left except where the sign includes an arrow pointing to the right, in which case the symbol shall face to the right

Figure 7-1 Permitted variants of diagram 661.1

LIMITED WAITING

7.8 The sign to diagram 661.1 indicates a free parking place where certain restrictions apply. The sign may include the times of operation, a particular class of vehicle (car, solo motor cycle or bus), and a limited waiting period, together with the time period during which a vehicle may not return. Examples are shown in figure 7-1. Outside the times of operation there are no restrictions on parking unless there are signs and markings to indicate otherwise. Where no class of vehicle is shown, the parking place may be used by any vehicle. The limited waiting period is



661.1 Limited waiting

An arrow may be added pointing to the left or to the right. The time periods may be varied. The name of the traffic authority may be added. The car, motor cycle or bus symbol may be added

Table 7-2 Bay markings used with the sign to diagram 661.1

Vehicle type	Road marking diagram no.
All vehicles	1028.4, 1032 or 1033, each with no legend
Motor car	1028.4, 1032 or 1033, each with no legend
Solo motor cycle	1028.4 with no legend, or with the legend SOLO MOTORCYCLES ONLY, SOLO M/CYCLES ONLY or SOLO M/CS ONLY
Bus	1028.3 with the legend BUSES

7.9 The sign must be used with a bay marking to diagram 1028.3, 1028.4, 1032 or 1033 (direction 24(1)), as specified in table 7-2.

PERMIT PARKING

7.10 Where a parking place is reserved for permit holders, a sign to either diagram 660 or 660.3 is used. The latter is effectively a permitted variant of diagram 660 and illustrates the use of permit identifiers. Diagram 660 may be varied for non-permit use at a bay reserved for large or slow vehicles, in which case it must be used with the bay marking to diagram 1028.3 varied to LARGE OR SLOW VEHICLES ONLY. Other permitted variants of diagram 660 are "Card holders only", "Doctor permit holders only", "Business permit holders only" and "Resident permit holders only". The bay markings used with the sign are specified in table 7-3.

7.11 Permit parking is provided where residents could have difficulty in parking close to their homes because road space would otherwise be taken up by commuters, shoppers etc. The use of the word "Resident" is optional; however it might help to identify the users of a permit scheme, particularly where the permit identifiers described in para 7.12 are not used. Permits may also be issued for other purposes, such as doctor permits to allow doctors to park close to a surgery where off-street parking is not available, and business permits to allow owners, managers or other permit holders to park close to their business premises, particularly if loading and unloading of vehicles is required.



660 Parking place for permit holders

An arrow may be added pointing to the left or to the right. Times, days and months may be added. The name of the traffic authority may be added. Permit identifiers may be added. "Permit holders" may be varied to "Card holders", "Doctor permit holders", "Large or slow vehicles", "Business permit holders" or "Resident permit holders" (any other class of permit holder requires authorisation)



660.3 Parking place for resident permit holders

An arrow may be added pointing to the left or to the right. Times, days and months may be added. The name of the traffic authority may be added. The permit identifiers may be varied. "Resident permit holders" may be varied to "Permit holders", "Doctor permit holders" or "Business permit holders" (any other class of permit holder requires authorisation)

Table 7-3 Bay markings used with signs to diagrams 660 and 660.3

Type of user	Road marking diagram no.
Permit holders	1028.4, 1032 or 1033, each with no legend, or 1028.4 with the legend PERMIT HOLDERS ONLY
Card holders (not diagram 660.3)	1028.4, 1032 or 1033, each with no legend
Doctor permit holders	1028.4, 1032 or 1033, each with either no legend or with the legend DOCTOR, or 1028.4 with the legend PERMIT HOLDERS ONLY
Business permit holders	1028.4, 1032 or 1033, each with no legend, or 1028.4 with the legend PERMIT HOLDERS ONLY
Resident permit holders	1028.4, 1032 or 1033, each with no legend, or 1028.4 with the legend PERMIT HOLDERS ONLY
Large or slow vehicles (not diagram 660.3)	1028.3 with the legend LARGE OR SLOW VEHICLES ONLY

7.12 Signs for permit parking may include permit identifiers as shown in diagram 660.3, and may use numerals in addition to letters (e.g. A1, A2 etc.). Identifiers might be necessary where schemes for different permit holders are in operation in adjacent areas. Each scheme would have its own identifier (e.g. "A" for one scheme and "B" for another) shown on the respective signs. To provide flexibility for residents, permit schemes may overlap so that some roads are common to two or more schemes. The signs on these roads would include the permit identifiers for each scheme as shown in diagram 660.3. Permit identifiers are often used in conjunction with a controlled parking zone (see section 12). For a stand-alone scheme, permit identifiers are not normally necessary. Identifiers are not used when diagram 660 is varied to "Card holders only" or to "Large or slow vehicles only".

7.13 Where permit identifiers are used, the letters and numerals must be from the Transport alphabet; there is no provision in regulation 13(7) for a different lettering style. The characters and the patch on which they are placed may be varied in size and may be in any contrasting colours, although the recommended size is as dimensioned on working drawing P 660.3 (see para 1.9). The recommended colours are white characters on black patches as shown in diagram 660.3.

7.14 Signs to diagrams 660 and 660.3 may be varied to include times of operation; examples are shown in figure 7-2. Outside those times any vehicle may park

in the bay unless there are signs and markings to indicate otherwise.

7.15 Where parking in an entire road is reserved solely for permit holders and where no other parking or loading activities are permitted, it might be possible to provide signs at the entrance to the road and dispense with signs and bay markings within the road itself. Figure 7-3 shows a typical entry sign. It should be noted that such signs are not prescribed by the Regulations and will require authorisation (see para 2.1). Design details are provided on working drawing NP 434, available from the Department on request. Many roads will not be suitable for this type of signing and any proposed scheme should be discussed with the Department at an early stage. The most likely candidates would be a cul-de-sac or a small network of roads with little or no through traffic. This type of signing might be appropriate in an environmentally sensitive area, or near a large sports stadium where parking restrictions are required only on certain days of the year (see para 7.41). The entry signs may be supplemented by signs to diagram 660 or 660.3, used as reminders in the individual streets. In this case a special direction should be sought from the Department (see para 2.1) to allow the signs to be used without bay markings. Any part of a road may include a prohibition of waiting (which would apply equally to permit holders) and be signed and marked as described in section 6. Signs indicating the end of the permit holder parking area will be needed, unless it is a cul-de-sac, and again these will require authorisation.

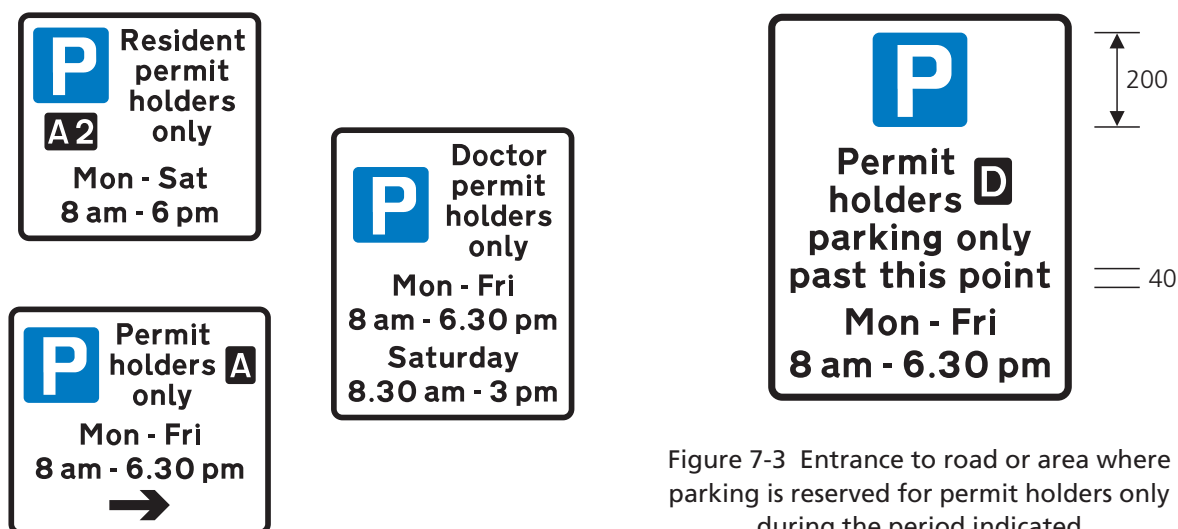

Figure 7-2 Permitted variants of diagrams 660 and 660.3

Figure 7-3 Entrance to road or area where parking is reserved for permit holders only during the period indicated

This sign is not prescribed by the Regulations and requires authorisation

DISABLED BADGE HOLDER PARKING

7.16 Disabled badge holders may usually park on single or double yellow lines for up to three hours in England and Wales; in Scotland there is no time limit. In Northern Ireland, although the three-hour limit applies, parking is not permitted on yellow lines within 15m of a junction. Disabled badge holders may not wait where there is a ban on loading or in a few areas where local schemes apply. They might also be exempt from limits on parking times or parking charges imposed on other users. Where there is a high demand for parking or where vehicles regularly load and unload on yellow lines, the provision of parking bays for disabled badge holders might be advantageous. Such bays are generally wider than ordinary parking bays, are not normally time limited and encourage disabled badge holders to park in the most appropriate locations.



661A Parking place for disabled badge holders

An arrow may be added pointing to the left or to the right. Times, days and months may be added. The name of the traffic authority may be added

7.17 The sign to diagram 661A may be used to give effect to an order which designates reserved parking places for disabled badge holders only. The orange badge symbol shown on diagram 661 of the 1994 Regulations has been replaced by the blue badge symbol shown in diagram 661A and all new signs must incorporate this symbol. Existing signs with the orange symbol may remain in place until 1 January 2010. The blue badge symbol always faces to the right, even when the sign incorporates an arrow pointing to the left.

7.18 The sign must be used with a bay marking to either diagram 1028.3, 1032 or 1033, in each case with or without the legend DISABLED. Diagram 1032 is a standard bay which should be used at its largest width of 2700mm. The other two bay markings have an increased width suitable for disabled badge

holder parking. See section 20 in Chapter 5 for further details regarding bay markings.

7.19 The times of operation may be included on the sign as shown on working drawing P 661A (see para 1.9). Outside these times any vehicle may park in the bay unless signs and markings indicate otherwise.

7.20 Disabled badge holder bays are often provided near facilities such as shops, doctors' surgeries and railway stations. However, there might be a need to provide bays that enable disabled people to park close to their homes in areas that either have parking bay provision for other road users (permit or otherwise) or where there are no parking controls but kerb space is often fully occupied by parked vehicles. Where other disabled badge holders are likely to deprive a resident of the use of the space, a resident permit holder bay should be considered, with the permit issued only to the designated person. The upright sign for this bay would be to diagram 660 or 660.3 and would need its own unique permit identifier. The bay marking would be to diagram 1028.4 with no legend. The bay marking to diagram 1028.3 cannot be used in this case without a special direction from the Department (see para 2.1).

PAY AND DISPLAY PARKING

7.21 The signs to diagrams 661.2A, 661.3A and 661.4 are for use in association with on-street pay and display schemes. The sign to diagram 661.2A includes an arrow indicating the direction to the nearest ticket machine. A second arrow may be added pointing in the opposite direction when the sign is sited between two machines. Where the ticket machine is on the other side of the road, the arrow should be omitted and the legend "Pay at machine" varied to either "Pay at machine across road" or "Pay at machine opposite". The sign to diagram 661.3A is used when sited close to the ticket machine. The sign to diagram 661.4 indicating "Have you paid and displayed?" is a reminder to drivers and is optional. The working drawings P 661.2A, P 661.3A and P 661.4 (see para 1.9) show the correct designs for these signs and their variants.

7.22 The signs to diagrams 661.2A and 661.3A must be used with the bay marking to diagram 1028.4, 1032 or 1033, in each case with no legend. The times of operation may be included on these two signs (see working drawings P 661.2A and



661.2A "Pay and Display" parking place

The arrow may point to the left. A second arrow pointing in the opposite direction may be added. The arrow may be replaced by the legend "across road" or "opposite". Times, days and months may be added. The name of the traffic authority may be added

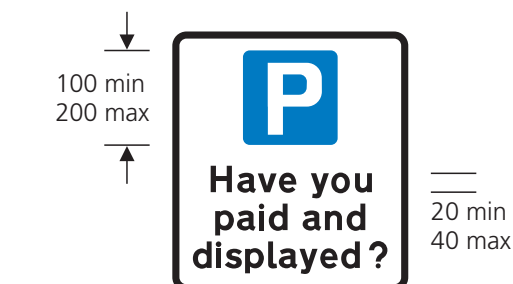

661.4 Reminder to drivers to obtain and display parking ticket (Alternative types)

The name of the traffic authority may be added



661.3A Location of "Pay and Display" ticket machine

Times, days and months may be added. The name of the traffic authority may be added

P 661.3A). Outside these times any vehicle may park in the bay without payment unless signs and markings indicate otherwise (e.g. a prohibition of waiting). A time limit on the duration of parking may also be shown on the signs in a similar manner to diagram 661.1. Where the period during which a vehicle may not return is not specified, the limited parking period is expressed as "Max stay 2 hours" where the time shown represents the maximum period for which a ticket may be purchased.

7.23 A parking place identifier, similar to a permit identifier (see paras 7.12 and 7.13), may be added to all pay and display signs, including the sign to diagram 661.4. This may be necessary where two pay and display schemes operate in adjacent roads and a ticket purchased from a machine in one road is not valid for parking in the other. To avoid driver confusion, it is recommended that wherever possible two or more different schemes (such as long stay and short stay parking) should not be introduced in the same road. However, where it is necessary to provide

adjacent bays that belong to two different schemes, two separate signs to diagram 661.2A should be erected side by side on the boundary. Each sign should have its own parking place identifier with an arrow pointing towards the appropriate ticket machine. There should also be separate bay markings for each scheme, set apart by a distance of at least 100 mm. When a pay and display parking bay is adjacent to a different type of bay such as a permit holders only bay, care should be taken in siting signs so that drivers are not misled into purchasing a ticket and parking in the wrong bay. Ticket machines also need to be sited carefully, for the same reason.

VOUCHER PARKING

7.24 Voucher parking involves the purchase of a voucher from a suitable local outlet, e.g. a nearby shop. It has the advantage that money is not kept in machines on site, there is reduced capital cost and less on-street clutter. The disadvantage is that vouchers are available only when the shops are open, which might reduce the times of operation of a scheme. Voucher parking is often more convenient for local people than for those making the occasional journey into a town. This tends to give priority for on-street parking to local people, encouraging others to use off-street car parks where available.

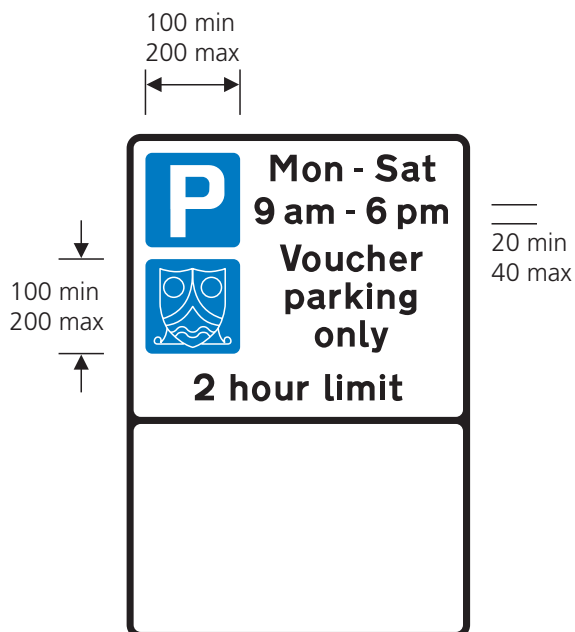

660.5 Parking place reserved for voucher parking during the period indicated

An arrow pointing to the left or to the right may be added to the upper panel. The time periods may be varied. The name of the traffic authority may be added. The words "and resident permits", "and business permits" or "and permits" may be added after "Voucher parking". The voucher parking symbol is to be varied to correspond with the voucher design within the size shown. Information about the voucher parking scheme may be shown in the lower panel. The lower panel may be omitted

7.25 A bay reserved for voucher parking is indicated by a sign to diagram 660.5. The voucher symbol shown on the sign may be varied within the size shown in the diagram, but must correspond to the design shown on the vouchers themselves. Information about the voucher scheme, such as charges and where vouchers may be purchased, should be shown on the lower panel of the sign and not in the upper panel. If this information is given elsewhere, the lower panel may be omitted. The sign must be used with a bay marking to diagram 1028.4, 1032 or 1033, in each case with no legend.

7.26 The parking bays may be shared with permit holders and the legend on the sign varied as shown on working drawing P 660.5 (see para 1.9). The bay marking is as described in para 7.25; it is not

appropriate to add the legend PERMIT HOLDERS ONLY to diagram 1028.4. Voucher parking may also be implemented as a controlled parking zone (see section 12).

LOADING BAYS

7.27 A parking place may be reserved for loading only, either by any class of vehicle or by goods vehicles. The provision of a loading bay reserves space for deliveries or for customers collecting goods, where it might otherwise be taken up by lawfully parked vehicles, including those of disabled badge holders parked on yellow lines where loading is not prohibited. Disabled badge holders may use loading bays, other than those reserved for goods vehicles, but only for as long as is necessary for the purposes of loading or unloading.



660.4 Part of the carriageway reserved for loading and unloading

An arrow pointing to the left or to the right may be added. The symbol may face to the right. Times, days and months may be added. The name of the traffic authority may be added. "Loading only" may be varied to "Goods vehicle loading only"

7.28 A loading bay is indicated by the sign to diagram 660.4. The loading symbol on the sign generally faces to the left unless an arrow pointing to the right is added; the symbol would then be reversed. Times of operation may be included on the sign as shown on working drawing P 660.4 (see para 1.9). Outside these times any vehicle may park in the bay unless signs and markings indicate otherwise (e.g. a prohibition of waiting and loading during peak periods). The order may include a time limit, which should be shown on the sign, but it needs to be sufficient to accommodate the most time-consuming loading operation likely to take place. This will depend on the nature of the business conducted in adjacent premises. Unless there is a

large demand for loading or a possibility that drivers might abuse the bay by combining loading with ordinary parking, a time limit should be avoided, so that the loading operation is allowed to take as long as is necessary. The bay may be used for loading by any vehicle unless the sign is varied to "Goods vehicle loading only".

7.29 The sign to diagram 660.4 must be used with a bay marking to diagram 1028.3 or 1032, each with the legend **LOADING ONLY**, or 1033 with no legend. The bay to diagram 1028.3 has the largest maximum width (3600mm) and is therefore the most appropriate for goods vehicle loading. Where the loading bay is used mainly by cars or small vans and has been provided to allow customers to collect large purchases from nearby shops, the smallest width of bay to diagram 1028.3 (2700mm) might be adequate. Diagrams 1032 and 1033 are also more appropriate for smaller vehicles.

PARKING AND LOADING BAYS WITH PROHIBITION OF WAITING AND LOADING AT CERTAIN TIMES

7.30 Where a parking or loading bay does not operate continuously, and there is a prohibition of waiting at certain times, a sign to diagram 639.1B should be used. This comprises either two or three panels depending on whether there is a prohibition of loading. The upper panel is yellow and gives details of the waiting restrictions. It is based on the sign to diagram 639 (see para 6.9) and may be varied to either diagram 650.2 or 650.3 (see para 6.12) where the parking or loading bay is used as a "no waiting" taxi rank at other times, perhaps overnight. The centre panel, if any, will include details of the loading prohibition. The top and centre panel will therefore be similar in design to diagram 640 (see para 6.9). The lower panel gives details of the parking or loading conditions. It may indicate limited waiting, permit parking, disabled badge holder parking, pay and display parking, voucher parking, a loading bay, shared-use parking or disc zone parking. It has the same design as one of the signs described previously in this section, other than diagrams 801 and 661.4, or the same design as the shared-use bay sign (see paras 7.33 to 7.37) or the "disc zone" sign to diagram 662 (see para 12.5). The permitted variants that apply to the individual signs for these parking bays also apply to the lower panel of diagram 639.1B. Examples of permitted variants of diagram 639.1B are shown in figure 7-4.

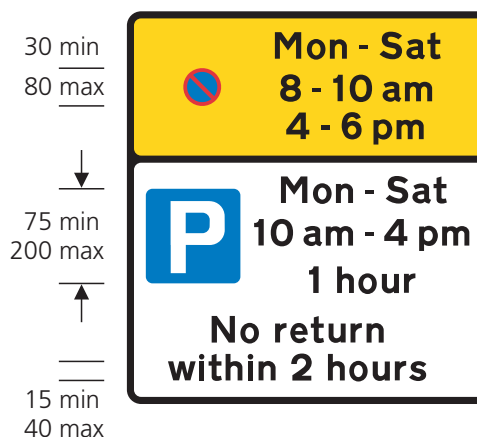

639.1B Prohibition of waiting at certain times and limited waiting at other times

The upper panel may be varied in a similar manner to diagram 639, or varied to diagram 650.2 or 650.3. The lower panel may be varied in a similar manner to diagram 661.1, or varied to diagram 660, 660.3, 660.4, 660.5, 660.6, 660.7, 661A, 661.2A, 661.3A or 662. A middle panel to diagram 638.1, with the size of legend as shown for diagram 639.1B, may be added

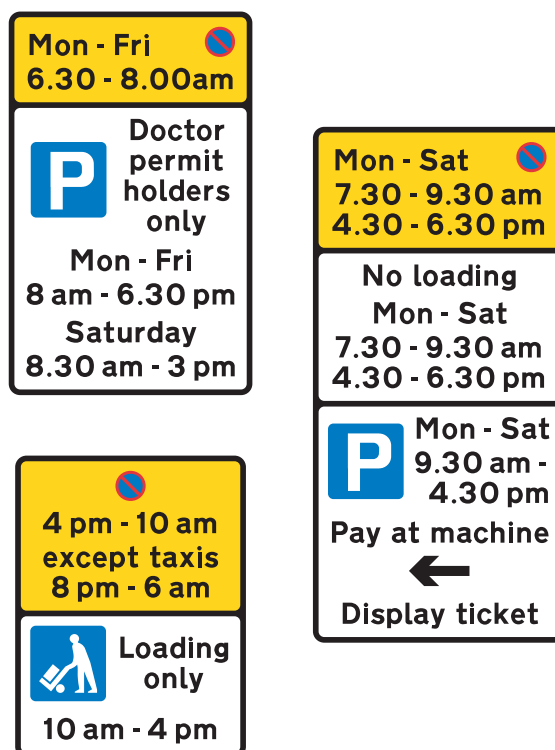

Figure 7-4 Permitted variants of diagram 639.1B

Table 7-4 Road markings used with the sign to diagram 639.1B

Panel	Sign diagram no.	Road marking diagram no.
Upper	639 No waiting 650.2 No waiting except taxis 650.3 No waiting except taxis	1017 1017 (diagram 1028.2 not used) (see para 7.32) 1017 (diagram 1028.2 not used) (see para 7.32)
Middle	No loading	1019
Lower	660 Permit holders Card holders Doctor permit holders Large or slow vehicles Business permit holders Resident permit holders 660.4 Loading Goods vehicle loading 660.5 Voucher parking 660.6 Permit holders/limited waiting 660.7 Permit holders/pay and display 661A Disabled badge holders 661.1 Limited waiting With car symbol With motor cycle symbol With bus symbol 661.2A Pay and display 661.3A Pay and display 662 Disc zone (see section 12)	1028.4, 1032 or 1033, each with no legend, or 1028.4 with the legend PERMIT HOLDERS ONLY 1028.4, 1032 or 1033, each with no legend 1028.4, 1032 or 1033, each with either no legend or with the legend DOCTOR, or 1028.4 with the legend PERMIT HOLDERS ONLY 1028.3 with the legend LARGE OR SLOW VEHICLES ONLY 1028.4, 1032 or 1033, each with no legend, or 1028.4 with the legend PERMIT HOLDERS ONLY 1028.4, 1032 or 1033, each with no legend, or 1028.4 with the legend PERMIT HOLDERS ONLY 1028.3 or 1032 each with the legend LOADING ONLY, or 1033 with no legend (see para 7.32 if upper panel is 650.2 or 650.3) 1028.3 or 1032 each with the legend LOADING ONLY, or 1033 with no legend (see para 7.32 if upper panel is 650.2 or 650.3) 1028.4, 1032 or 1033, each with no legend 1028.4, 1032 or 1033, each with no legend 1028.4, 1032 or 1033, each with no legend 1028.3, 1032 or 1033, each with either no legend or with the legend DISABLED 1028.4, 1032 or 1033, each with no legend 1028.4, 1032 or 1033, each with no legend 1028.4 with no legend, or with the legend SOLO MOTORCYCLES ONLY, SOLO M/CYCLES ONLY or SOLO M/CS ONLY 1028.3 with the legend BUSES 1028.4, 1032 or 1033, each with no legend 1028.4, 1032 or 1033, each with no legend 1028.4, 1032 or 1033, each with no legend

NOTE: When lower panel is varied to diagram 660.3 (Resident permit holders, Permit holders, Doctor permit holders, Business permit holders), road markings apply as for the lower panel when varied to diagram 660.

7.31 The time periods for parking and for the prohibition of waiting should not overlap. The format “no waiting from 8 am to 6 pm except limited waiting from 10 am to 4 pm” (diagram 639.1A in the 1994 Regulations) is no longer used. “except” is omitted and the prohibition of waiting expressed as two separate periods; “8 - 10 am” and “4 - 6 pm”. The upper panel when varied to diagram 650.3 will have to indicate a time period other than “At any time” on the top line. However, there might be situations where it is appropriate to use the expression “At any time” in the upper panel, whether or not it has been varied to indicate a taxi rank. For example, the parking bays might not operate on a particular day of the week because a market is held on that day and the waiting prohibition applies for 24 hours.

7.32 The sign is used with a parking bay appropriate to the lower panel, a single yellow line to indicate the prohibition of waiting in the upper panel and, if appropriate, single kerb marks to indicate a prohibition of loading. Where the single yellow line continues beyond the bay, and the upright signs indicate different waiting restrictions, a transverse mark as described in para 6.35 is not required. The end of the bay is sufficient to indicate a change in the restrictions. Where the upper panel is varied to either diagram 650.2 or 650.3, the yellow taxi rank bay marking to diagram 1028.2 is not used. The bay marking will be white and appropriate to the lower panel. In this case the bay marking should have no legend as this would conflict with its use by taxis. Where this is a loading bay to diagram 1028.3, a special direction is required from the Department (see para 2.1) as the Directions currently require the legend **LOADING ONLY** to be used. A single yellow line to diagram 1017 is still used to indicate the prohibition of waiting even though there is an exception for taxis. Table 7-4 specifies the appropriate markings to use.

SHARED-USE PARKING BAYS

7.33 The Regulations prescribe signs for permit parking bays that may be used by other vehicles at either the same or different times. The sign to diagram 660.6 is used where there is time-limited parking, and diagram 660.7 where there is pay and display parking in addition to permit parking. The legend “Permit holders” may be varied to “Resident permit holders”, “Business permit holders”, “Doctor permit holders” or “Card holders”.

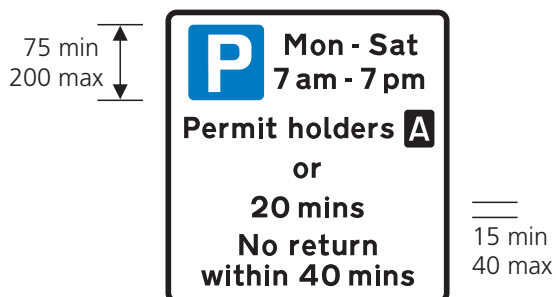
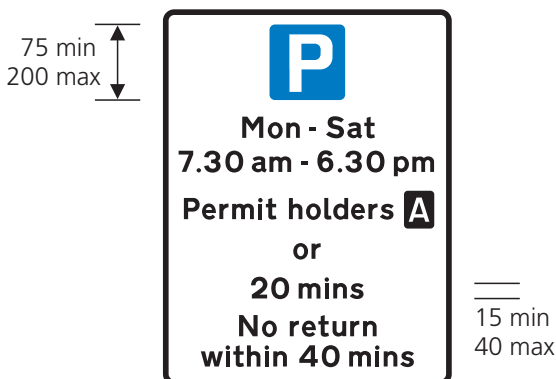
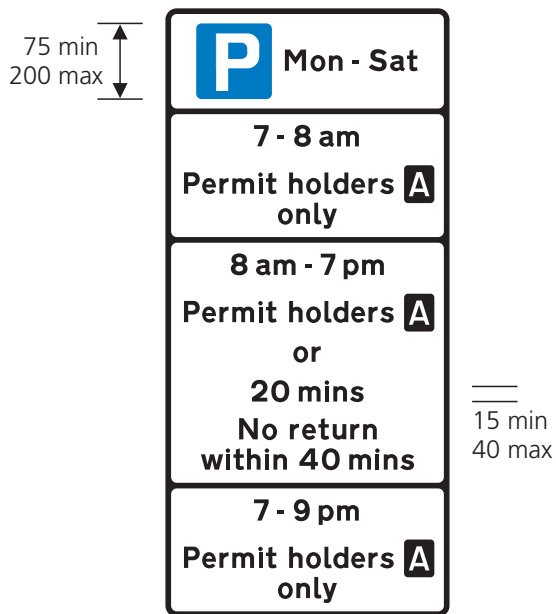

660.6 Parking place for permit holders with limited waiting by others at specified times (Alternative types)

See paras 7.33 to 7.37 for permitted variants

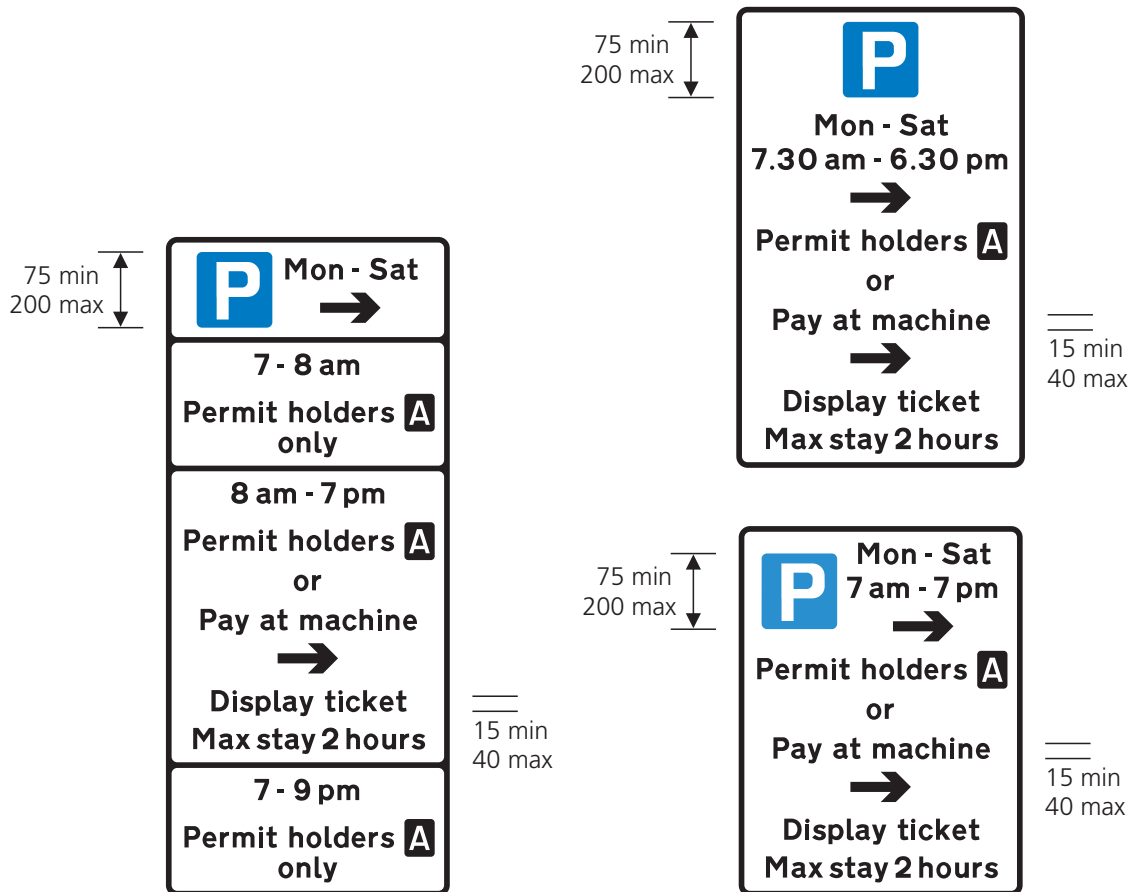

660.7 Parking place for permit holders with paid limited waiting by others at specified times (Alternative types)

See paras 7.33 to 7.37 for permitted variants

7.34 A bay might simply have dual use throughout the period of operation, in which case the sign would have a single panel in the format “Permit holders or” followed by a description of the other type of parking (limited waiting, or pay and display). The conditions that apply to the other parking do not apply to permit holders. Because the bay is shared at all times, the word “only” is not used after the words “Permit holders”. Where the bay has different uses at different times, the sign is divided into separate panels, one for each time period during the day. Each time period might have exclusive use (e.g. permit holders only) or shared use (e.g. permit holders or pay and display). The time periods should be shown in chronological order.

7.35 As shared-use bays are predominantly permit bays, permit holders are likely to be able to park throughout the day without any further restrictions. However, it might be desirable to reserve the bays

for permit holders at certain times of the day only, such as early morning and early evening. At other times, the conditions that apply to other users would also apply to permit holders. The appropriate panel on the sign would show only limited waiting or pay and display parking with no reference to permit holders (see figure 7-5).

7.36 The arrow near the top of each sign shown in diagram 660.7 indicates the start of the parking place and should be omitted when the sign is not located at the end of the bay. An arrow may be added to diagram 660.6. The arrow lower down the sign to diagram 660.7 indicates the direction to the ticket machine. This part of the sign can be varied in the same manner as diagram 661.2A (see para 7.21).

7.37 The time periods shown on the signs can be varied as appropriate. However, as the signs can be quite complex and hence large, it is recommended

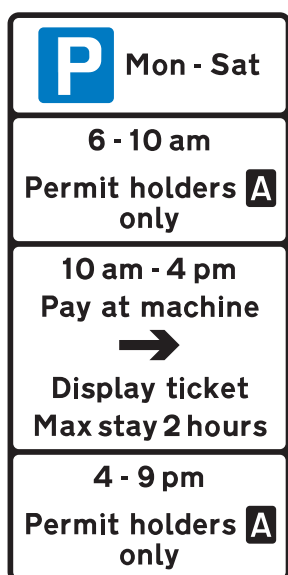
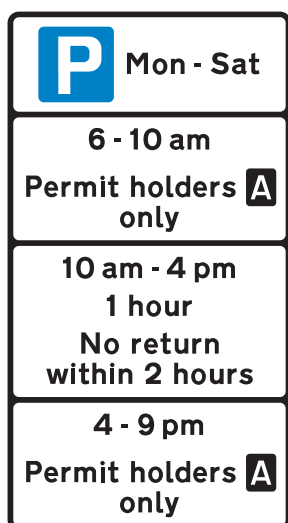

Permit parking does not apply between 10 am and 4 pm in the above examples. All vehicles are subject to the same parking conditions during that period

Figure 7-5 Permitted variants of diagrams 660.6 and 660.7

that the time periods and conditions shown apply for each day of the week that the bay is operational (e.g. Monday to Saturday or every day of the week). To have different conditions applying on different days will result in complicated signs and might confuse drivers. Where different conditions do apply, it might be necessary to use separate signs, for example where parking conditions on Sundays differ from those for the other days of the week.

7.38 Where a prohibition of waiting also applies at certain times of the day, a sign to diagram 639.1B (see paras 7.30 to 7.32) should be used, the lower panel being varied to either diagram 660.6 or 660.7.

7.39 The signs to diagram 660.6 and 660.7 must be used with a bay marking to diagram 1028.4, 1032 or 1033, in each case with no legend. As the bay is not for the exclusive use of permit holders, it is not appropriate to vary diagram 1028.4 to PERMIT HOLDERS ONLY.

OTHER PARKING ARRANGEMENTS

7.40 Where signing and marking of certain on-street parking arrangements is not possible under the current Regulations and Directions, it will be necessary to seek authorisation from the Department (see para 2.1). However, traffic authorities should carefully consider the signing requirements for proposed traffic regulation orders. It is very easy for signs to become over-complicated, resulting in sign overload and sign clutter. Not only can this make comprehension by road users difficult but it is likely to be detrimental to environmentally sensitive areas, and can lead to enforcement difficulties.

7.41 Roads in the vicinity of a football stadium or similar venue might need parking controls on match days to reserve road space for resident permit holders. Signs for the prohibition of waiting and those that indicate parking conditions will normally make reference to "Match days" or "Event days" and will require authorisation. Additional signs are used to indicate the date of the next match or event. In certain areas, the signs described in para 7.15 might be appropriate. This would avoid the need to mark out parking bays required only for a limited number of days throughout the year. It would also reduce the number of upright signs needed. Where the match day controls are additional to existing controls, the signs become more complex. Consideration should therefore be given to applying the same controls throughout the year, such as permit holders only at all times, so that reference to match days is not required. This would simplify the signing and would not require authorisation. However, this might not be always be possible, particularly where there are parking bays for non-permit holders and these are required for permit holders on match days. It might be possible to impose controls so that only certain lengths of

road need additional signing for match days, the remainder having controls that are the same throughout the year.

7.42 Where a very short cul-de-sac is to be used for loading only, an alternative to providing loading bays, where that is not practicable, is to designate the road as a parking place for loading and unloading only. A sign based on figure 7-6 could then be erected at the entrance to the road. This is not prescribed and requires authorisation (see para 2.1).

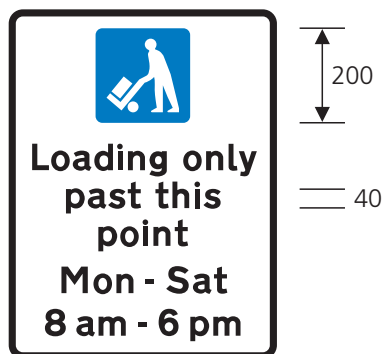

Figure 7-6 Entrance to road or area where parking is reserved for loading or unloading only during the period indicated

This sign is not prescribed by the Regulations and requires authorisation

7.43 Where the sign to diagram 639.1B is used to indicate a taxi rank shared with a parking or loading bay, the upper panel of the sign may be varied to diagram 650.2 or 650.3 (no waiting except taxis) (see paras 7.30 to 7.32). However, it cannot be varied to diagram 650.1 (no stopping except taxis) without authorisation from the Department (see para 2.1). It is not appropriate to use two separate prescribed signs, one to diagram 650.1 and the other to indicate a parking or loading bay, as the Directions do not permit both signs to be used with the same road marking. Diagram 650.1 must be used only with the marking to diagram 1028.2 (yellow taxi bay); this is not appropriate for a parking or loading bay. A new shared-use bay marking has therefore been devised for use with the authorised version of diagram 639.1B where the upper panel has been varied to diagram 650.1. This marking, which also has to be authorised by the Department, is similar to diagram 1028.3 or 1028.4 with no

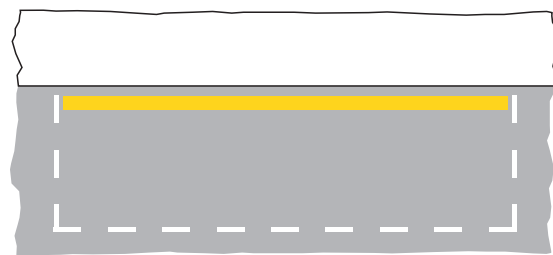

Figure 7-7 Example of a shared “no stopping” taxi rank and loading bay

The sign and road marking are not prescribed by the Regulations and require authorisation

legend. It includes the wide yellow line alongside the kerb as prescribed for both bus stop clearways (diagram 1025.1) and the “no stopping” taxi rank (diagram 1028.2 variant). An example of a sign and the road marking is shown in figure 7-7.

7.44 There might be some locations where a parking bay has shared use and where an appropriate combined sign is not prescribed by the Regulations, e.g. loading only and disabled badge holder parking at different times of the day. Although two separate prescribed signs could be used, it might not be possible to provide a bay marking that is common to both signs. In the case of the shared loading and disabled badge holder bay, the only common road marking is diagram 1033 when no legend appears (echelon parking with the narrower standard bay). Diagrams 1028.3 and 1032 must have the legend **LOADING ONLY** when used with the sign to diagram 660.4 (loading only) and this legend cannot be used with diagram 661A (disabled badge holders only). Therefore a special direction from the Department is required (see para 2.1) to allow diagram 1028.3 without any legend to be used with both diagram 660.4 and 661A. An alternative would be to apply for authorisation for a combined loading and

disabled badge holders sign. The above principles apply also to other combinations of parking bays. However, the shared use of bays in this manner is likely to result in more complicated signs and may lead to enforcement difficulties, particularly as the bay marking cannot have legend describing its use (such as LOADING ONLY or DISABLED).

SIGN DESIGN, SIZE AND SITING

7.45 The detailed design of signs for on-street parking and loading is set out on the appropriate working drawings (see para 1.9), with additional guidance in section 12 of Chapter 7. **Note that panel dividers are always the same width as the sign border.** A restriction always applies at all times unless qualified by an indication that it applies only at specific dates or times. It will lead to confusion, and undermine understanding of restrictions signed according to this convention, if expressions like "Mon-Sun" are used. Similarly, restrictions apply on public holidays unless signs specifically indicate that they do not.

7.46 Where new traffic regulation orders are to be introduced, parking controls should be kept as simple as possible to avoid over-complicated traffic signs that might be difficult for drivers to understand. Where a shared-use bay includes different provisions on different days, it might be possible to simplify the sign by using the legend "At other times", although this will require authorisation. An example is shown in figure 7-8. Where public holidays are excluded from the order, this should be indicated on the signs, otherwise drivers will not know that the parking controls do not apply on these days.

7.47 Most of the signs for parking and loading bays are prescribed with an x-height in the range 20 mm minimum to 40 mm maximum. The appropriate x-height for such signs is determined by the need to ensure conspicuity rather than by the speed of traffic. Therefore the smaller x-heights are more appropriate for signs displaying larger amounts of information. For this reason, the potentially large signs to diagrams 639.1B, 660.6 and 660.7 (but not diagram 660.5) are prescribed with a minimum x-height of 15 mm. Selection of x-height will depend on prevailing conditions and the design of the sign. In a quiet, narrow residential street the smallest prescribed size is likely to be adequate for any sign. However, in a

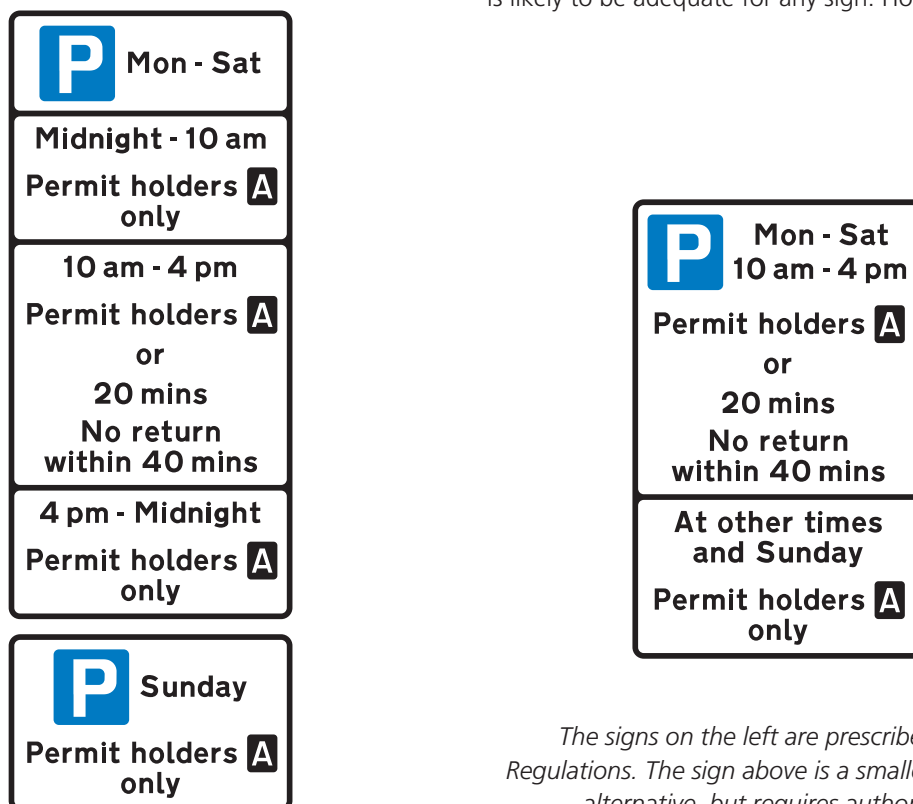

The signs on the left are prescribed by the Regulations. The sign above is a smaller and simpler alternative, but requires authorisation

Figure 7-8 Use of the expression "At other times" (see para 7.46)

busy high street or a wide suburban road, a larger x-height, such as 25 mm, is likely to be required unless the sign has high target value. The largest size of 40 mm x-height should be used where a sign needs to be made more conspicuous in areas where there are background distractions and perhaps where the sign is mounted at the back of the footway. Where two separate signs are mounted together at a point where parking controls change, they should both have the same x-height.

7.48 The “parking place” sign to diagram 801 is prescribed in six sizes, ranging from 250 mm square to 1000 mm square. The larger sizes are used for lay-bays and parking areas on high-speed roads. The three smallest sizes of 250 mm, 375 mm and 500 mm are used for on-street parking places and, where appropriate, should be mounted above a vehicle-type supplementary plate (diagram 804.1, 804.2, 804.3 or 804.4) of the same width. The “bus parking place” sign to diagram 969 is also prescribed with widths of 250 mm, 375 mm and 500 mm. Sign size will depend on location and the amount of background distraction. In narrow roads the smallest size should be adequate, but for wide roads or where signs are mounted at the back of the footway a larger sign might be required. Larger signs might also be appropriate where parking is provided in an area separate from the main carriageway, such as in the centre of a town square.

7.49 On-street parking and loading signs are normally erected parallel to the kerb, facing the carriageway. Where conspicuity is not compromised, signs may be mounted at the back of the footway on posts, walls or railings to minimise street clutter. This is also likely to be preferable where the footway is narrow. In environmentally sensitive areas where the post is sited at the back of the footway, consideration might be given to painting it a similar colour to the adjacent building (direction 41 allows a post to be any single colour, including its natural colour).

7.50 Signs should be provided at approximately 30 m intervals, i.e. half the distance recommended for signs indicating a prohibition of waiting (see para 6.34). As white bay markings denote a place where a driver might be able to park, information about the permitted parking is required at more frequent intervals, particularly where the bay marking does not have any legend to indicate the type of user. The first sign should be no more than 15 m from the end of the bay. Where the length of the bay is less than 30 m, a sign mounted at the mid-point should

therefore be sufficient (but see para 7.51). Where the road marking to diagram 1032 or 1033 is used, it is not necessary to provide a sign for each individual space. The whole run of parking spaces should be treated as a single bay for the purposes of signing (i.e. signs should be placed at approximately 30 m intervals). It should be noted that the start and end of a parking bay to either diagram 1032 or 1033 is marked with a double transverse line, and that individual spaces within the bay are marked with a single transverse line. The upright signs apply to the whole length of the bay between the double transverse lines at each end. To minimise the possibility of driver confusion, wherever practicable the intermediate signs should be sited in line with the single transverse lines to emphasise that a particular sign does not apply to a single parking space.

7.51 Where two different parking bays are side by side (e.g. a loading bay adjacent to a disabled badge holder bay), consideration should be given to mounting two signs side by side, preferably on a grey backing board, at the changeover point. Each sign should include an arrow pointing in the direction of the respective bay. This should minimise the risk of drivers parking in the wrong bay by mistake and incurring a penalty. Where the assembly would not be too tall, the signs could be mounted one above the other. The sign with the left-pointing arrow should be at the top.

7.52 Where a footway has vehicle crossovers serving private accesses, it is preferable to terminate parking bays at each crossover to avoid the possibility of parked vehicles blocking vehicular access to adjacent property. However, as the Directions require that each bay has an upright sign, this could lead to a proliferation of signs where each individual property has a crossover. A possible solution might be to provide a continuous bay along the length of the road and to mark each crossover with the advisory “keep clear” marking to diagram 1026.1. Another possibility would be to consider whether the type of signing described in para 7.15 is appropriate.

SUSPENSION OF A PARKING OR LOADING BAY

7.53 Where it is required to suspend a parking or loading bay, e.g. to enable works to be carried out, a temporary sign should be provided. These are not prescribed by the Regulations, other than for parking meters (see para 6.30), and guidance should therefore be sought from the Department.

8 VERGE OR FOOTWAY PARKING

GENERAL

8.1 In London, parking is not permitted on the footway or verge unless a resolution of the local authority under section 15(4) of the Greater London Council (General Powers) Act 1974 authorises the provision of parking places, either partially or wholly on the footway. Elsewhere, vehicles are not specifically prohibited from parking on the footway or verge (although it is unlawful to drive on the footway), unless (a) an order has been made (see para 6.11) or (b) there is a prohibition of waiting; this normally applies from the centre of the carriageway to the highway boundary (see para 6.2). Outside London, an order that bans footway parking may designate certain sections of footway as parking places.

8.2 On some residential streets, parked vehicles restrict the passage of through traffic and make access by emergency vehicles very difficult. The problem can often be resolved by the introduction of a prohibition of waiting, perhaps on one side of the road only. However, in areas of dense housing where off-street parking is very limited, such a prohibition could disadvantage residents. If this is the case, the provision of footway parking could be considered.

8.3 Care should be taken when selecting suitable sites; the remaining width of footway needs to be wide enough for pedestrians and should allow for two push chairs to pass each other. There could also be serious implications for visually impaired pedestrians and other disabled persons, such as those who use wheelchairs or electric scooters, as they might find their way obstructed. The minimum clear width for pedestrians should therefore be 1500 mm. It might be better to provide parking bays partially on the footway on both sides of the road rather than parking bays wholly on the footway on one side with carriageway parking on the other. This would evenly distribute available footway width on both sides of the road, although it would not be practicable if one footway is very narrow or non-existent. In some roads, the provision of parking bays partially on the footway on one side only might be sufficient to allow safe passage of through traffic. The footway should also be of suitable construction to allow vehicle parking. Where there is a scheme to improve a road, the opportunity should be taken to consider the provision of lay-bys as an alternative to footway parking.

8.4 Parking bays provided on the footway should normally operate at all times. Drivers should not be expected to park on the footway for part of the day and wholly on the carriageway at other times. This would be inconvenient and confusing, particularly where a bay has been marked partially on the footway and partially on the carriageway. Where there is a specific need to keep the footway clear and, in the case of bays partially on the footway, to keep the carriageway clear at certain times of the day, there should be a prohibition of waiting at the appropriate times. Where, in exceptional circumstances, parking is permitted on the footway for only part of the day and on the carriageway at other times, bay markings should not be provided (see para 8.6).

USE OF SIGNS AND MARKINGS

8.5 Signs to diagrams 667, 667.1 and 667.2 are used to indicate that parking may take place partially on the footway. Signs to diagrams 668, 668.1 and 668.2 indicate that parking is permitted wholly on the footway. These six diagrams include a symbol which shows the footway to the left of the carriageway. Where, from the driver's point of view, the parking bays are on the right hand side of the road and the signs face oncoming traffic, the symbol is reversed to show the footway to the right of the carriageway. Where a sign is mounted parallel to the kerb and includes an arrow (see para 8.12), the symbol shall show the footway to the right of the carriageway when the arrow points to the left and vice versa. The symbol then represents the true situation when looking in the direction of the arrow. Sign design details are set out on the appropriate working drawings (see para 1.9).

8.6 The signs described in para 8.5 may be used without any road markings. This would be appropriate where parking is allowed on a verge unsuitable for road markings or where there is no specific requirement for a designated parking place as described in section 7. Where bay markings are to be provided they must be to diagram 1028.4; no other marking is prescribed for verge or footway parking. For a bay that is wholly on the footway the three-sided version only must be used, the fourth boundary being the kerblines. The Regulations do not prescribe the four-sided marking for use wholly on the footway (i.e. remote from the kerb). This version

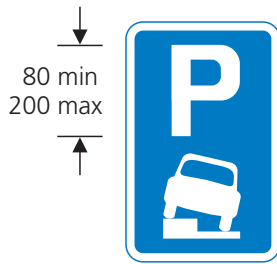

667 Vehicles may be parked partially on the verge or footway

An arrow may be added pointing to the left or to the right. The symbol of the car on the footway may be reversed in a mirror image

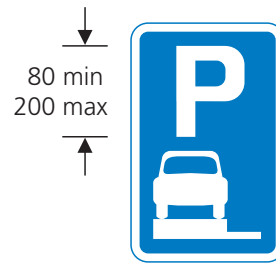

668 Vehicles may be parked wholly on the verge or footway

An arrow may be added pointing to the left or to the right. The symbol of the car on the footway may be reversed in a mirror image



667.1 Vehicles may be parked partially on the verge or footway during the period indicated

An arrow may be added pointing to the left or to the right. The time period may be varied. "In marked bays" may be added to or substituted for the time period. The symbol of the car on the footway may be reversed in a mirror image



668.1 Vehicles may be parked wholly on the verge or footway during the period indicated

An arrow may be added pointing to the left or to the right. The time period may be varied. "In marked bays" may be added to or substituted for the time period. The symbol of the car on the footway may be reversed in a mirror image



667.2 End of area where vehicles may be parked partially on the verge or footway

The symbol of the car on the footway may be reversed in a mirror image



668.2 End of area where vehicles may be parked wholly on the verge or footway

The symbol of the car on the footway may be reversed in a mirror image

of the marking is used for a bay that is partially on the footway and partially on the carriageway; no markings shall be omitted for that part of the bay which is on the carriageway. Where conditions apply to the parking place (see para 8.10), any legend associated with the marking to diagram 1028.4 must always be placed on the carriageway side of the bay and not on the footway. As the Regulations do not prescribe diagram 1028.3 for footway parking, a special direction from the Department will be required (see para 2.1) to allow diagram 1028.4 with no legend to be used with diagrams 660.4, 661A etc. If the legend LOADING ONLY, DISABLED etc. is required, the bay marking will need to be authorised.

8.7 Direction 8 requires a sign to diagram 667, 667.1, 668 or 668.1 to be located where footway parking commences. This sign normally faces oncoming traffic, but may be mounted parallel to the kerb (see para 8.12), in which case it should include an arrow pointing to the left or to the right as appropriate (see para 8.5). On a two-way road a sign must be provided at each end of the bay, whether facing oncoming traffic or parallel to the kerb. A sign to diagram 667.2 or 668.2, facing oncoming traffic, indicates the end of footway parking. On a two-way road it should be mounted back to back with the start sign at each end of the bay. Where a start sign is parallel to the kerb, it is not necessary to provide a sign to diagram 667.2 or 668.2 at the same location. There is no specific requirement to provide repeater signs as direction 11 does not apply to signs indicating footway parking (but see para 8.8).

8.8 The start sign would normally be to diagram 667 or 668, whether or not bay markings have been provided. Any individually marked bay would need to be signed separately as described in para 8.7. Where parking bays are interrupted by private accesses, trees and street furniture, an alternative is to provide a sign to diagram 667.1 or 668.1 with the lower panel varied to "In marked bays". Such a sign need only be erected at each end of the run of bays and should face oncoming traffic (see figure 8-1). Signs for intermediate bays would not usually be required. However, separate signing should be provided where the run of bays is interrupted by a road junction or a kerbed private access, or where a section of the road between the bays is subject to a prohibition of waiting. Additional signs might be required where there is a road junction opposite the parking bays and drivers entering from that road need to be made aware of the parking requirements.

Repeater signs to diagram 667 or 668 are optional and may be provided as considered necessary, mounting them on lamp columns if appropriate. Repeater signs are more likely to be necessary where road markings have not been provided.

8.9 Where the parking place operates for only part of the day, the sign to diagram 667.1 or 668.1 is used showing the appropriate times. The legend "In marked bays" should be added above the time period when the signs are used as described in para 8.8. At other times there should be a prohibition of waiting (see para 8.4), signed in accordance with section 6 and with signs located so as not to obstruct the parking bay or the footway. Where possible they may be co-located with the footway parking signs. A yellow line to diagram 1017 should be provided along the edge of the carriageway. This will run through the middle of a marked bay where this is partially on the footway (see figure 8-2). Where parking is wholly on the footway, double yellow lines to diagram 1018.1 (no waiting at any time) should not be provided as a means to prevent parking on the carriageway, as the restriction would apply equally to the footway (see para 6.2). Any repeater signs indicating parking on the footway should be to diagram 667.1 or 668.1, showing the appropriate time periods; it is not necessary to include the legend "In marked bays" where the road marking to diagram 1028.4 has been provided.

8.10 Where conditions apply to the parking place, such as permit parking, limited waiting or pay and display, signs should be provided as described in section 7 at the intervals specified in para 7.50, and must include the appropriate variant of the bay marking to diagram 1028.4 (see para 8.6). Sometimes it will be necessary to site the upright signs at the back of the footway. A sign to diagram 667.1 or 668.1, with the legend "In marked bays", should be provided at the start of the bay or run of bays, with a sign to diagram 667.2 or 668.2 at the end. Repeater signs to diagram 667 or 668, indicating footway parking, are not necessary in this case. It might sometimes be preferable to omit the start and end of footway parking signs and seek authorisation from the Department to vary parking place signs to include the footway parking symbol. Figure 8-2 shows an example of a time-limited parking bay using a non-prescribed variant of diagram 661.1, but similar signs, also requiring authorisation, could indicate other types of parking such as pay and display or permit holders only.

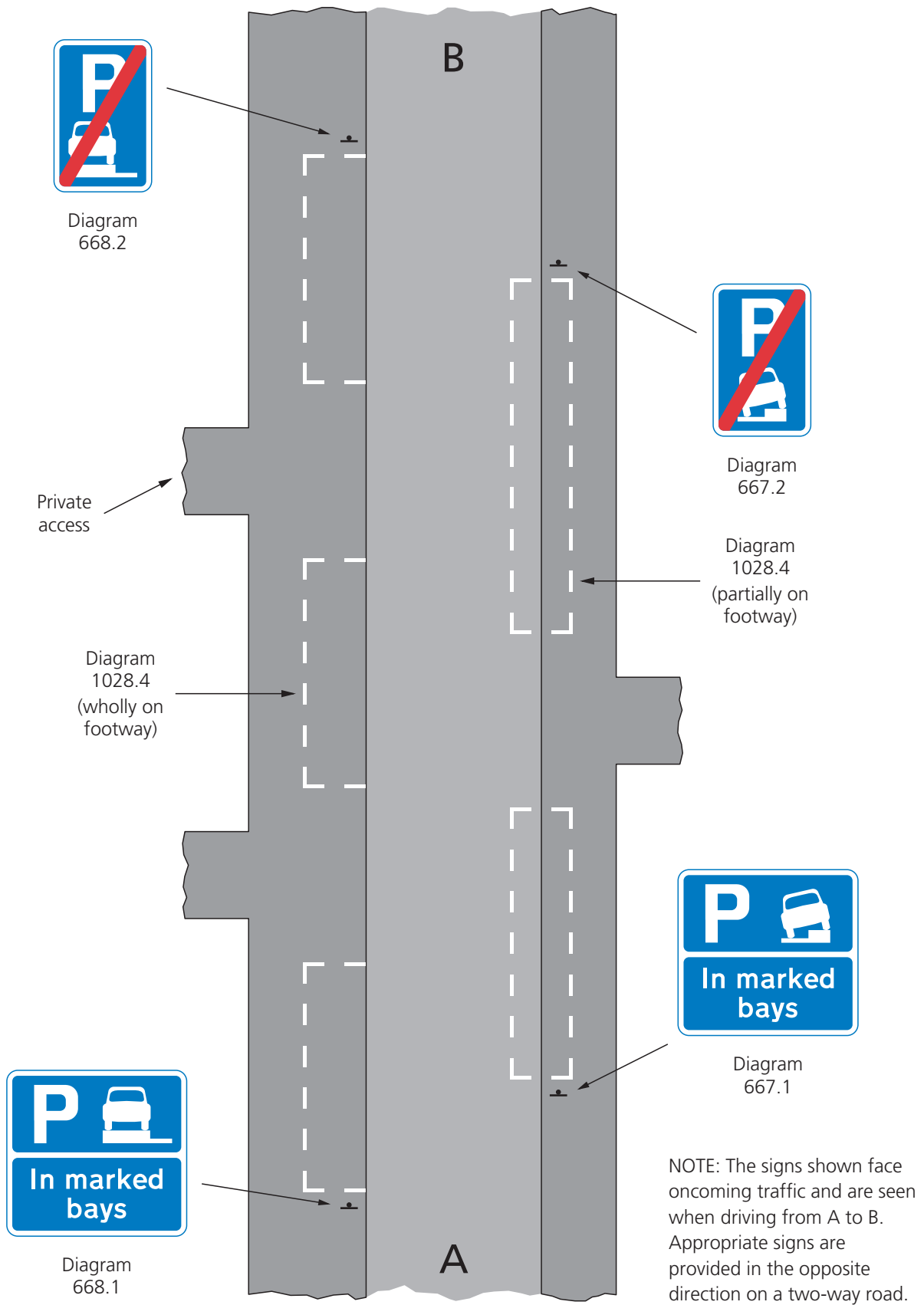

Figure 8-1 Example of signing marked parking bays wholly and partially on the footway (see para 8.8)

Table 8-1 Size of signs facing oncoming traffic (height of "P" symbol in millimetres)

Diagram No.	Marked bay	85th percentile speed of private cars (mph)			
		Up to 20	21 to 30	31 to 40	Over 40
667 & 668	Yes	80	100	120	160
	No	100 (80)	120 (100)	160 (120)	200 (160)
667.1 & 668.1	Yes	160	180	200	200
	No	160 (120)	180 (160)	200	200
667.2 & 668.2	Yes	80	100	120	160
	No	100 (80)	120 (100)	160 (120)	200 (160)

NOTE: The smaller bracketed sizes are appropriate only where special amenity considerations apply.

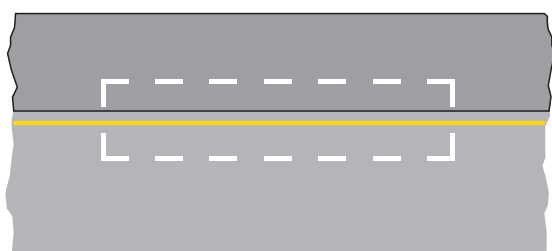

Figure 8-2 Example of a parking bay partially on the footway, with a prohibition of waiting during peak hours and limited waiting during the day-time from Monday to Saturday (see paras 8.9 and 8.10)

The upright sign is not prescribed by the Regulations and requires authorisation. Overnight and Sunday parking has been included on the sign to indicate that footway parking is available at these times

SIGN SIZE AND SITING

8.11 The signs for footway parking are prescribed with an x-height in the range 20 mm minimum to 50 mm maximum. For signs that have no legend, the size is prescribed by reference to the height of the "P" symbol, which is equal to four times the x-height. Where the sign faces oncoming traffic and is intended to be read from a moving vehicle, its size needs to be appropriate to the circumstances. Signs need to be larger when the 85th percentile speed is higher, where there is a time plate that drivers need to read, and where there are no bay markings to make the footway parking more conspicuous. Appropriate sizes are shown in table 8-1. Where signs are parallel to the kerb, the smaller sizes are likely to be appropriate. Intermediate sizes might be required to increase conspicuity where signs are mounted at the back of the footway or where bay markings have not been provided.

8.12 The start and end signs are normally mounted to face oncoming traffic. However, there might be situations where it is more practical to mount signs parallel to the kerb, similar to other parking signs. In these circumstances an end sign is not required. A start sign is located at each end of the parking bay and shall include an arrow as described in para 8.5, pointing in the direction of footway parking. The arrow should not be used to indicate that there is footway parking along another road, to the left or to the right. Although the Regulations permit the addition of an arrow to the end sign (diagrams 667.2 and 668.2) it is unlikely that there will be situations where this will be appropriate. Where bay markings are not provided, the start of footway

parking should always be indicated by diagram 667 or 668, with arrows, mounted parallel to the kerb. If the signs were to face oncoming traffic (without arrows), they could be mistaken for repeater signs, tempting drivers to park in advance of them where footway parking is prohibited. Signs to diagrams 667.1 and 668.1 may be mounted parallel to the kerb, particularly where they indicate a time period rather than the legend "In marked bays" and where they are used as repeater signs. Signs located at each end of a parking bay should include an arrow. Where a sign to diagram 667, 667.1, 668 or 668.1 is mounted parallel to the kerb, the footway parking symbol should always have the footway shown to the left except where the sign includes an arrow pointing to the left; the symbol is then reversed.

8.13 Where used, repeater signs do not have to be erected at any specific intervals. The siting of these will depend on the need to remind drivers that

footway parking is permitted, particularly where there are no bay markings. Locating signs immediately adjacent to the parking bay might not be practicable where posts would be in the middle of the footway and be a hazard to pedestrians. However, existing lamp columns might be suitable for mounting the signs, either parallel to the kerb or back to back facing oncoming traffic. Elsewhere, it might be necessary to mount the signs at the back of the footway on posts, walls or railings, but care must be taken to ensure that conspicuity is not compromised.

8.14 Where signs are provided to indicate waiting restrictions or parking controls, they should be in accordance with the size and siting requirements set out in sections 6 and 7 respectively. It might be necessary to mount these signs at the back of the footway (see para 8.13).

9 CLEARWAY AND NO STOPPING SIGNS

GENERAL

9.1 Signs for waiting and loading prohibitions can be found in section 7. This section deals with signs for the more restrictive prohibition of stopping, except red route signs and markings which are covered separately in section 10.

9.2 Generally, a “no stopping” prohibition does not allow a private vehicle to stop for any purpose (except in an emergency or where exempted in the order), even to pick up and set down passengers. Signs therefore need to be seen from a moving vehicle. They should be of a sufficient size for the speed of traffic and should face oncoming vehicles (but see paras 9.16, 9.23 and 9.28), otherwise drivers might need to stop to read them, thereby committing an offence. Guidance on sign size and siting is given under each topic below.

24-HOUR RURAL CLEARWAY

9.3 A 24-hour clearway order prohibits stopping on the main carriageway for any purpose at all times. It is suitable for use only on semi-urban or rural roads where there are very few premises requiring access from the main carriageway. Its main purpose is to ensure the free flow of traffic on major inter-urban routes, especially dual carriageway roads and single carriageway primary routes. The restriction applies to the main running carriageway, slip roads and any acceleration and deceleration splays included in the order. It does not apply to verges, footways, lay-bys and other highway areas. To enable drivers to stop for a break, there should be lay-bys at frequent intervals. They should also be provided for isolated properties on the route where no off-carriageway area is available for parking and loading.

9.4 The clearway would not normally continue through a village or small settlement. Where there is a need to keep the main carriageway clear of stationary vehicles, a 24-hour prohibition of waiting is more appropriate as this allows the picking up and setting down of passengers and, where not also prohibited, loading and unloading.

9.5 There might sometimes be a need to prevent parking on the verge where the ground is soft or newly seeded, or for road safety or security reasons, such as near an airfield. This can be achieved by making an order prohibiting either waiting or

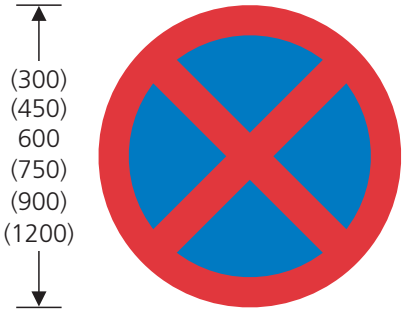

642 No stopping on main carriageway

May be used in combination with diagram 570 or 645

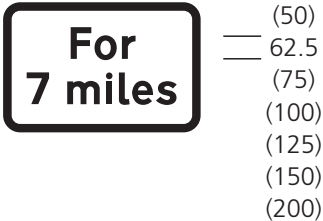

570 Distance in miles over which 24-hour clearway extends (when used in combination with diagram 642)

The distance may be varied (see Appendix B)

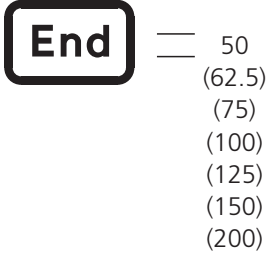

645 End of 24-hour clearway (when used in combination with diagram 642)

stopping on the verge and using the sign to diagram 637.1 as described in paras 6.10 and 6.37.

9.6 The start of the clearway is indicated by signs to diagram 642 together with supplementary plates to diagram 570 indicating the restricted length in miles; this must be to the *nearest whole mile* if the distance is greater than three miles. The signs must

be erected on each side of the road or, in the case of a dual carriageway, on the near side and on the central reservation (direction 8). The end of the clearway is indicated by a sign to diagram 642 supplemented by an "End" plate to diagram 645. These signs should be erected on each side of the carriageway, mounted back to back with the commencement signs where appropriate. Smaller repeater signs, which may alternate from one side of the carriageway to the other, should be placed at intervals of approximately 1600m in each direction where the speed limit is 60 mph or more. Where the speed limit is 40 or 50 mph, the spacing should be reduced to 1100 m and 1350 m respectively, to maintain an interval between successive signs of approximately 60 seconds. Where street lighting is provided, the repeater signs may be mounted on the lamp columns.

9.7 Where a road joins or crosses a clearway, a commencement sign to diagram 642 should be erected on each side of the carriageway of that road to face traffic approaching the junction. The supplementary arrows prescribed by the 1994 Regulations as diagrams 643 and 644 are no longer used. A distance plate is not used as in most cases traffic can turn either left or right into the clearway. However, distance plates should be provided if the road is a slip road leading to a dual carriageway. For traffic turning into the side road and leaving the clearway it will normally be sufficient to provide a single sign to diagram 642 together with an "End" plate on the left hand side of the minor road. Complex junctions with splitter islands, link roads or slip roads might require additional signs.

9.8 Appropriate sign and plate sizes are specified in Appendix A. No road markings are used in conjunction with a 24-hour clearway.

URBAN CLEARWAY

9.9 The urban clearway prohibits stopping during peak periods, but is effectively a prohibition of waiting and loading as drivers may stop to pick up and set down passengers. It applies to both sides of the carriageway and is indicated by the sign to diagram 646 erected on each side of the road to face oncoming traffic. The sign indicates two time periods representing the morning and evening peak periods; it cannot be varied to show a single time period such as 8 am to 6 pm. As road markings are

not used with urban clearways, signs should be provided in both directions just after each side road junction. The signs should be sited a sufficient distance from the junction to enable them to be read by drivers turning into the clearway, but generally no more than 45 m measured from the backline of the side road. Care will need to be taken when siting signs at a staggered crossroads or where junctions are very close together. Where junctions are more than 400m apart, additional signs should be provided to maintain a spacing of not more than 400m. The end of the clearway is indicated by the sign to diagram 647. In most cases, this will be mounted on both sides of the road back to back with the commencement sign to diagram 646. Signs to diagrams 646 and 647 are not normally provided on side roads that join or cross an urban clearway.

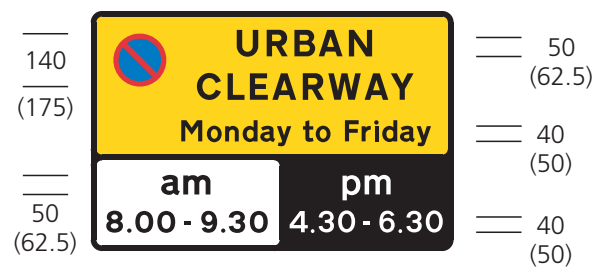

646 No stopping for the periods indicated, except to pick up or to set down passengers

The times of day and days of the week may be varied

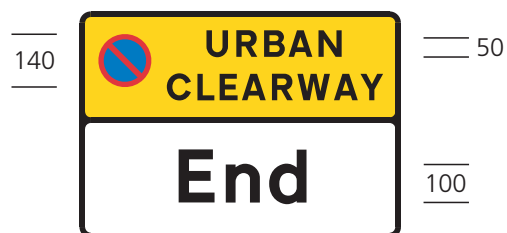

647 End of restriction on stopping

9.10 The Regulations prescribe two sizes for the sign to diagram 646. The larger size would normally be used on roads with a speed limit of 40 mph or more. Only one size is prescribed for diagram 647.

9.11 An urban clearway should be introduced only where there are no other on-street parking controls, even if they operate at a different time of day. The provision of a prohibition of waiting with time plates could be confusing to drivers as could a time-limited parking bay that operates off-peak, implying that outside those times (during peak periods) the bay can be used without limit. The only additional restriction that could sensibly be applied would be a 24-hour prohibition of waiting to protect junctions. Where other controls are required, the urban clearway should be replaced by a prohibition of waiting and loading and signed accordingly.

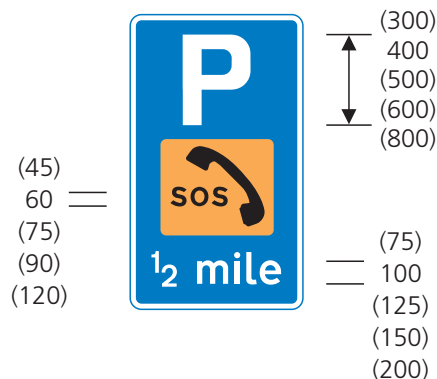

2713.1 Distance to parking place with emergency telephone

The distance may be varied (see Appendix B) or omitted. An arrow pointing to the left or to the right may be added. The "P" symbol may be placed to the left of the orange panel or omitted

NO STOPPING EXCEPT IN EMERGENCY

9.12 Where a lay-by has been provided for the sole purpose of accommodating an emergency telephone, an order can be made prohibiting stopping by any vehicle other than in an emergency. This prohibition is indicated by a sign to diagram 642.3 which has no permitted variants; it applies at all times and cannot include a period that is less than 24 hours or less than seven days a week. The sign must be used with the double yellow line road marking to diagram 1018.1 (direction 24(1)). Yellow kerb marks to diagram 1020.1 denoting a prohibition of loading are not used. The yellow lines should extend for the whole length of the lay-by. Normally one sign to diagram 642.3 adjacent to the emergency telephone will be sufficient; this should be orientated to face vehicles entering the lay-by.



Location of emergency lay-by with telephone

Distance to emergency lay-by with telephone

2713.1 Permitted variants indicating a lay-by for emergency use only



642.3 No stopping in lay-by except in emergency

May be used only in conjunction with diagram 1018.1

9.13 Two sizes of sign are prescribed. The choice of x-height will depend on local circumstances. In most situations the smaller size will be sufficient. The larger size should be used where it is required to make the sign more conspicuous.

9.14 The sign to diagram 2713.1 is an informatory sign used to indicate to drivers approaching a lay-by that it has an emergency telephone. Where the whole lay-by is for emergency use only as described in para 9.12, the "P" symbol is omitted as shown on working drawing P 2713.1 (see para 1.9). This sign is placed adjacent to the main carriageway where the lay-by commences and faces oncoming traffic. An advance sign, including a distance, should normally be provided approximately half a mile before the lay-by. The size of these signs depends on the speed of traffic and is shown in table 9-1.

Table 9-1 Size of emergency lay-by sign

85th percentile speed of private cars (mph)	Size of diagram 2713.1 (x-height of distance) (mm)
Up to 30	75
31 to 40	100
41 to 50	125
51 to 60	150
Over 60	200

NO STOPPING ON ENTRANCE MARKINGS

9.15 Guidance on the use of the KEEP CLEAR marking to diagram 1027.1 can be found in Chapter 5, paras 22.19 to 22.25. Where this marking is to be enforced by the making of an order, a sign to diagram 642.2A is required. It may be used outside a hospital or a fire, police or ambulance station, as well as at school premises. The time period shown may be varied as appropriate but the legend “during term time” must not be used. This legend is not prescribed by the Regulations as not all drivers will be familiar with the exact dates of each school term, particularly as these can vary from one area to another. When the “no stopping” order applies at all times, the time period is omitted as shown on working drawing P 642.2A (see para 1.9). The expression “at any time” must not be used as this does not comply with Schedule 16, item 38.



642.2A No stopping on entrance markings

May be used only in conjunction with the marking to diagram 1027.1. The time period may be varied or omitted. The “no stopping” symbol may be placed centrally above the top line of legend

9.16 The sign to diagram 642.2A is prescribed in only one size. As drivers should not stop on a KEEP CLEAR marking unless they already know they are outside its operational hours, it is not essential for it to face oncoming traffic, although this will make it more conspicuous and leave no doubt about when it applies. Where the road is two way, at least two signs will be required if they are to face oncoming traffic, one facing in each direction. In many situations the two signs can be mounted back to back near the centre of the road marking. Where this is not practicable (e.g. outside a fire station) the two signs should be erected separately near each end of the marking. Where more than one marking is used, in accordance with Chapter 5, para 22.21, a sign to diagram 642.2A will be required for each marking.

9.17 Where both the KEEP CLEAR marking and the mandatory sign to diagram 642.2A are used on a road that is also subject to a prohibition of waiting, the latter should be independently signed, with the yellow line to diagram 1017 or 1018.1 running behind the KEEP CLEAR marking (see para 22.25 in Chapter 5). As waiting restriction signs are spaced at approximately 60 m intervals (see para 6.34), it is possible that there might not be such a sign alongside the KEEP CLEAR marking. However, it would be helpful to drivers to provide a sign (except where the restriction is no waiting at any time) as a reminder that waiting restrictions apply during times when the prohibition of stopping does not. The sign could be co-located with diagram 642.2A. This also applies within a controlled parking zone, where upright signs are normally dispensed with (see para 12.2). Where the prohibition of waiting applies only during times that are covered by the stopping prohibition, yellow lines and signs are not needed, except that yellow lines are still required within a controlled parking zone (see para 12.1(a)(i)). The signing and marking of a prohibition of loading should be treated in the same way as the prohibition of waiting.

BUS STOP CLEARWAYS

9.18 Before the 2002 Regulations came into force, an order was required for a bus stop clearway. The significance of the bus stop clearway markings shown in diagrams 1025.1, 1025.3 and 1025.4 (see Chapter 5, paras 17.20 to 17.23) is now specified and standardised by regulation 29(1) so that they can be used to convey the prohibition specified

in Part I of Schedule 19 (see Appendix C for full details). There is no longer a requirement for a traffic regulation order. Regulation 10(1) makes it an offence to fail to comply with the indication given by these markings. There is no longer a specific requirement (under the Road Traffic Regulation Act 1984) to consult on the introduction of a new bus stop clearway, but it is strongly recommended that those likely to be affected should be consulted over the location and times of operation of the proposed restrictions. It should be noted that Schedule 19 permits taxis to stop in a bus stop clearway to pick up or set down passengers.

9.19 Schedule 19, paragraph 2 and direction 25(1) both require that the road marking is used in conjunction with an upright sign to either diagram 974 or 975. The time period shown on the sign may be varied or omitted as appropriate. It must not be changed to the expression "at any time" as this does not comply with either Schedule 16, item 38 or Schedule 19, paragraph 2(a).

9.20 Diagram 974 is used where the road marking legend is BUS STOP and diagram 975 where the road marking legend is BUS STAND. In Schedule 19, paragraph 1(a) the definition of a "clearway" includes both bus stops and bus stands, whereas the definition of a "bus stop clearway" relates only to bus stops and not to bus stands. The requirement of Schedule 19, paragraph 3(a) is that a bus may stop in a "clearway" for as long as it is necessary to maintain a scheduled service, but in the case of a "bus stop clearway" there is a time limit of two minutes. Therefore, if buses are expected to stop for longer than two minutes, other than to pick up and set down passengers or for a change of crew, the clearway should be marked and signed as a bus stand.

9.21 Schedule 19, paragraph 3 allows only local buses to use a bus stop clearway; the signs to diagram 974 and 975 should therefore be varied to include the word "local" before "buses". As the meaning of the road marking is specified in Schedule 19, it is not appropriate for it to be provided at bus stops used by non-local buses, except where the marking was laid before the 2002 Regulations came into force and the bus stop clearway is supported by an order. In this case the upright sign without the word "local" may continue to be used. It is not appropriate to make a new order for a bus stop clearway with conditions different from those set out in Schedule 19. Where non-local buses need



974 Place where only buses may stop during the period indicated, for the purpose of picking up and setting down passengers

May be used only in conjunction with the marking to diagram 1025.1, 1025.3 or 1025.4, in each case indicating "BUS STOP". The time period may be varied or omitted. The word "local" may be omitted



975 Place where buses may stand and the stopping of other vehicles is prohibited during the period indicated

May be used only in conjunction with the marking to diagram 1025.1, 1025.3 or 1025.4, in each case indicating "BUS STAND". The time period may be varied or omitted. The word "local" may be omitted

to use a bus stop this should be signed only with the bus stop flag sign to diagram 970. If necessary, a prohibition of waiting and loading may be imposed (see section 6). It should be noted that the advisory bus stop marking prescribed by the 1994 Regulations as diagram 1025 or 1025.2 was no longer lawful from 1 January 2007 (regulation 3(2)(b)) and should have either been removed or converted to a bus stop clearway.

9.22 Where the bus stop clearway does not operate at all times, a prohibition of waiting might be required at other times. It is not practicable, nor

permitted by direction 22(3), to provide a yellow line to either diagram 1017 or 1018.1 within a bus stop clearway marking. However, direction 24(2) does allow a waiting restriction sign to diagram 637.3, 639 or 640 to be placed alongside a bus stop clearway, and in such circumstances exempts these signs from direction 24(1) that normally requires them to be provided only in conjunction with a road marking to diagram 1017 or 1018.1 (as appropriate). Except in the case of diagram 637.3 where the legend "At any time" cannot be varied, the time period indicated on the signs should not overlap the operational period of the bus stop clearway. If a loading ban is also required, the sign to diagram 640 should be used. Again there is no requirement to provide the associated road marking, in this case diagram 1019 or 1020.1 indicating the prohibition of loading. However, direction 22(3) does not prevent the use of such markings and it might be desirable to provide them.

9.23 As the broad continuous yellow line that forms part of the bus stop clearway marking is intended to indicate that stopping is prohibited, it is not essential that the signs to diagram 974 and 975 face oncoming traffic, particularly where the prohibition is continuous. However, where the sign shows a time period it will be helpful to drivers if the sign does face oncoming traffic. The sign should normally be located near the centre of the bay or mounted on the post that supports the bus stop sign to diagram 970, 973.2 or 973.3. Where the bus stop marking has been extended to accommodate two or more buses, it might be preferable to mount the sign close to the beginning of the bay. In these circumstances an additional sign, mounted parallel to the kerb, might be required near the centre of the bay.

9.24 The signs are prescribed with an x-height in the range of 20 mm minimum to 40 mm maximum. The smallest size is only appropriate where the sign is parallel to the kerb as the x-height is too small for the sign to be read from a moving vehicle. Where the sign faces oncoming traffic the x-height should be 40 mm.

NO STOPPING ON TAXI RANKS

9.25 The signing of a taxi rank, where waiting by other vehicles is prohibited, is dealt with in paras 6.12 to 6.17. The sign to diagram 650.1 is used where other vehicles are prohibited from stopping in a taxi rank. The road marking is the yellow bay



650.1 Prohibition of stopping by vehicles other than taxis during the period indicated

May be used only in conjunction with the marking to diagram 1028.2 varied to include the continuous yellow line shown in diagram 1025.1. An arrow pointing to the left or to the right may be added. The time period may be varied or omitted. The legend "taxis" may be varied to "ambulances" or "police vehicles"

to diagram 1028.2; this must include a broad continuous yellow line in the manner shown in diagram 1025.1 (direction 24(1)).

9.26 The time period shown on the sign to diagram 650.1 may be varied as appropriate, or omitted when the taxi rank operates at all times. For taxi ranks that operate only overnight, the signing is simplified where the operational period is the same on every day of the week; e.g. 11 pm - 5 am. If the rank did not operate Sunday night and Monday morning, the signing would be more complex and potentially confusing; e.g. Monday 11 pm - Midnight; Tues - Sat Midnight - 5 am, 11 pm - Midnight; Sunday Midnight - 5 am.

9.27 Where a prohibition of waiting, and perhaps a prohibition of loading, is required during times when the taxi rank is not operational, para 9.22 above applies in the same way that it applies to a bus stop clearway, as direction 22(3) refers to diagram 1028.2 (when used with diagram 650.1) and direction 24(2) refers to diagram 650.1. Para 7.43 deals with the situation where a "no stopping" taxi rank has shared use at different times with a parking or loading bay.

9.28 As the broad continuous yellow line that forms part of the taxi rank marking is intended to indicate that stopping is prohibited, it is not essential that the sign to diagram 650.1 faces oncoming traffic. However, where the sign shows a time period it might be helpful to drivers if the sign does face oncoming traffic. Where the rank has been designed to accommodate no more than five taxis, the sign

should normally be located near the centre of the bay. For longer taxi ranks, it might be preferable to mount a sign close to the beginning of the bay. In these circumstances additional signs, mounted parallel to the kerb, might be required near the centre of the bay. Where signs are mounted parallel to the kerb at the start and end of a taxi rank, an arrow should be added to the sign.

9.29 The signs are prescribed with an x-height in the range of 20 mm minimum to 40 mm maximum. The smallest size is only appropriate where the sign is parallel to the kerb, as the x-height is too small for the sign to be read from a moving vehicle. Where the sign faces oncoming traffic, the x-height should be 40 mm.

9.30 An informatory sign to diagram 857.1 may be provided to display fare tables and any additional information such as the number of taxis allowed to wait in the stand and the conditions of hire (see para 6.16).

9.31 The Regulations allow the legend "taxis" on the sign to diagram 650.1 to be varied to "ambulances" or "police vehicles". Likewise the legend TAXIS forming part of the bay marking to diagram 1028.2 may be varied to AMBULANCES or POLICE. Paras 9.25 to 9.29 apply to these variations in the same way that they apply to taxi ranks.

9.32 The supplementary plate "On taxi rank", prescribed by the 1981 Regulations as diagram 642.1 and used in combination with diagram 642, ceased to be lawful from 1 January 2005 (regulation 3(2)(a)(iii)). These signs should now have been replaced by diagram 650.1.

TEMPORARY PROHIBITION OF STOPPING

9.33 The sign to diagram 636.2 indicates a temporary prohibition of stopping and is used mainly by the police in an emergency. If the sign is used by a local traffic authority to indicate the effect of a temporary order, the name of the authority must be shown on the sign, replacing the name of the police authority (see direction 39(4)). In most cases where a road needs to be kept clear for planned works, a temporary prohibition of waiting and loading will be adequate (see paras 6.26 to 6.29).

9.34 The time period shown may be varied or omitted; the expression "At any time" is not used (see Schedule 16, item 38). The sign, which is prescribed in one size only, should face oncoming traffic and be placed at regular intervals along the length of road to which the restriction applies. As there is no "End" sign, the signs to diagram 636.2 should be fairly closely spaced so that it is clear where the restriction ends.

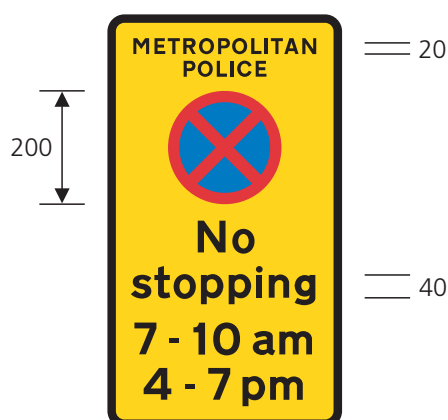

636.2 Temporary prohibition of stopping during the periods indicated

*The time periods may be varied or omitted.
The name of the police force may be varied to the appropriate force, "POLICE" or "Police", the name of the traffic authority, or omitted.
"No stopping" may be on one line*

10 RED ROUTES

10.1 Where urban roads are heavily trafficked and there is a need to control parking to maintain the free flow of vehicles, it is normally sufficient to prohibit waiting and loading at specific times of day as described in section 6. However, this does not prevent vehicles stopping for the purpose of picking up and setting down passengers, which in itself can contribute to traffic congestion on very busy roads.

10.2 A relatively new type of control is the red route, first introduced in London. This prohibits stopping, much like the rural 24-hour clearway (see section 9), but is more flexible as it does not need to operate for the whole day and provision can be made for parking and loading at certain times. Red routes are intended to be used strategically to deal with traffic problems assessed on a whole-route basis, not to deal with issues on relatively short lengths of road. Unlike the 24-hour clearway, the prohibition of stopping applies also to the verge and footway. A licensed taxi may stop to pick up or set down passengers, and the driver of a vehicle displaying a blue badge may stop to pick up or set down a disabled person; drivers of other vehicles are not permitted to stop for any purpose other than in an emergency. As the name "red route" implies, the road markings are red (but see para 10.9), so a red route has to be introduced in isolation and cannot be combined with the more conventional yellow line restriction. It is not possible to introduce a peak-hour prohibition of stopping with waiting restrictions at other times; red and yellow lines cannot both be laid along the same length of road. Therefore red route controls either operate for 24 hours or, if overnight parking can be permitted, throughout the day, typically 7 am to 7 pm.

10.3 Provision will need to be made for loading where this is essential for businesses along the route and cannot be accommodated either off-highway or on adjacent roads. A red route can therefore include

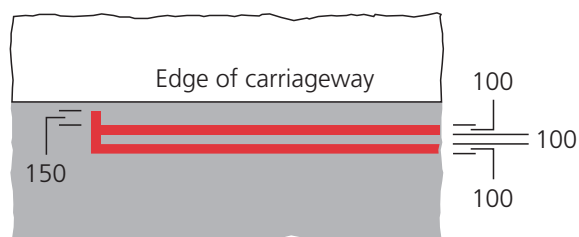

Figure 10-1 Road marking: No stopping on red route at any time



Figure 10-2 No stopping on red route

Used in conjunction with figure 10-1

loading bays which operate either for the full duration of red route control or for some shorter period. Loading bays might not be required where the red route operates during day-time hours only and loading can take place overnight. Provision may be made for on-street parking, particularly for disabled badge holders, where there is no alternative. Time-limited waiting by any vehicle might be required where small retail businesses, for example, could be adversely affected by red route controls. Parking and loading bays should normally be the exception rather than the rule and should be provided only over short lengths of road. To do otherwise could undermine the concept of the red route, which is intended to provide a road free of stationary vehicles. However, where controls that operate throughout the day (e.g. 7 am to 7 pm) are primarily intended to prevent stopping during peak hours, it will not be necessary to restrict the provision of loading and parking bays if these are required only during off-peak periods. A bay may have dual use, e.g. used both by disabled badge holders and for loading.

10.4 Figures 10-1 to 10-13 illustrate signs and markings for red routes. These are not prescribed by the Regulations and need to be authorised. An authority seeking to introduce a red route should enter into early discussions with the Department before developing a detailed scheme.

10.5 A red route that prohibits stopping at any time is indicated by a double red line (see figure 10-1, but also para 10.9), similar to the double yellow line meaning no waiting at any time. It is accompanied by the upright sign shown in figure 10-2 facing oncoming traffic. A single red line is used where the red route operates for part of the day or where it operates for 24 hours, but not on every day of the week (see figure 10-3). A typical upright sign which accompanies the single red line marking is shown in

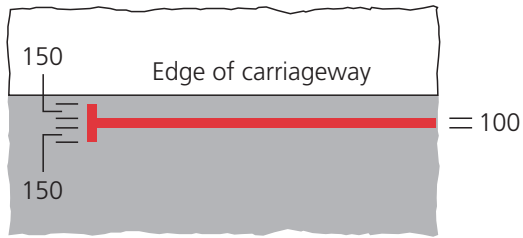

Figure 10-3 Road marking: No stopping on red route during the period indicated on the associated sign



Figure 10-4 No stopping on red route during the specified period

Used in conjunction with figure 10-3

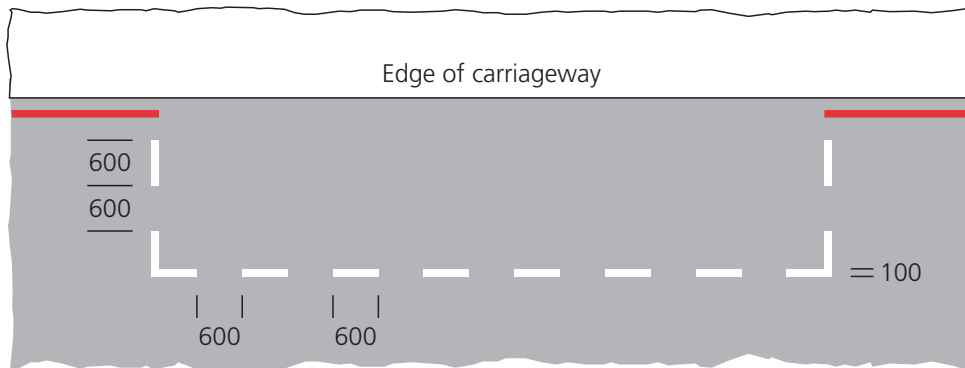

Figure 10-5 Parking or loading bay always available for a specified class of user during the period of operation of a red route

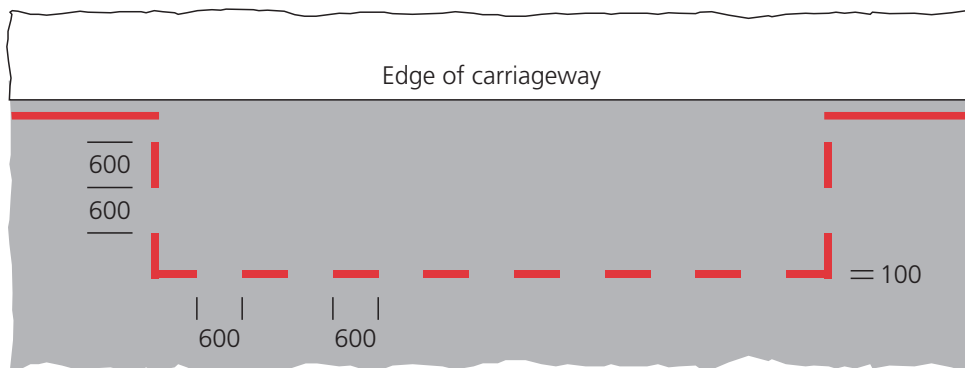

Figure 10-6 Parking or loading bay available for a specified class of user during part of the period of operation of a red route with no stopping at other times



Figure 10-7 No stopping on red route during the hours shown in the middle panel except for loading

Used in conjunction with figure 10-5



Figure 10-8 No stopping on red route during the hours shown in the middle panel except disabled badge holders

Used in conjunction with figure 10-5

figure 10-4. All upright signs should face oncoming traffic as drivers need to be able to read them without stopping, otherwise they might be committing an offence. Signs need to be sufficiently frequent for drivers to be clear what restriction applies.

10.6 Where a parking or loading bay is provided, this will be similar to diagram 1028.4 in the Regulations, but is coloured either white or red according to the times of operation. If the bay is available at all times during red route control it is coloured white. If the bay operates for only part of the day and there are times, such as peak hours, when stopping in the bay is prohibited, it is coloured red. It is not necessary, in this instance, to provide a continuous single red line alongside the kerb within the bay as the colour of the bay denotes that there are certain times when stopping is prohibited. This is different from a bay with a peak-hour prohibition of waiting where the yellow line continues through the bay (see section 6). The two types of bay marking are shown in figures 10-5 and 10-6.

10.7 Examples of upright signs for parking and loading bays are shown in figures 10-7 to 10-9 and generally comprise three panels. The uppermost is a header panel for the red route. The middle panel gives the times of operation of the red route. The lower panel gives details of the permitted parking or loading. The design of the sign is similar to diagram 639.1B in the Regulations, but differs in one

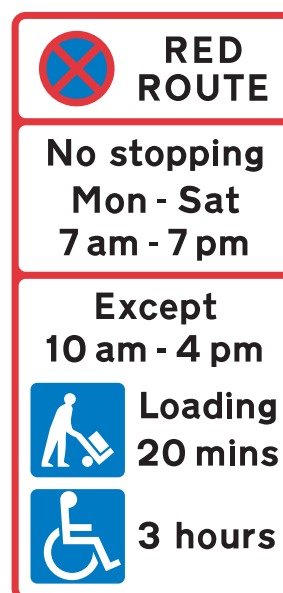

Figure 10-9 No stopping on red route during the hours shown in the middle panel except for loading and disabled badge holders during the period shown in the bottom panel

Used in conjunction with figure 10-6

important aspect. Like the predecessor to diagram 639.1B (diagram 639.1A in the 1994 Regulations), the lower panel uses the expression "Except", with the middle panel showing the full period that the red route operates. For example, if the red route operates

from 7 am to 7 pm, with a loading bay that operates from 10 am to 4 pm, the middle panel displays the legend “No stopping 7 am - 7 pm” rather than “No stopping 7 - 10 am, 4 pm - 7 pm”. Not only does this act as a reminder to drivers that the red route is operational throughout the day, but also indicates that stopping in the bay is not permitted except at the times and for the purposes set out in the lower panel. As with the signs referred to in para 10.5, all parking and loading bay signs should face oncoming traffic, otherwise a driver might be tempted to stop in a bay to read the sign, and in doing so risk the possibility of committing an offence. Where drivers are likely to approach the bay from the opposite side of the road, a sign should also face in that direction. This could be achieved by placing a sign at each end of the bay, facing outwards towards approaching traffic. For bays over 30 m in length, additional signs will be required. These may be parallel to the kerb or back to back facing traffic in each direction.

10.8 To enable buses to stop on a red route, bus stop clearways will be needed. The road marking is similar to diagram 1025.1 or 1025.4, except that the broad continuous line alongside the kerb is coloured red as shown in figure 10-10. The remainder of the marking, including the legend BUS STOP, is yellow. The upright sign is shown in figure 10-11. This should normally face oncoming traffic, as for other red route signs. However, provided the operational period is not longer than that for the red route as a whole, the sign may be mounted parallel to the kerb, as the broad continuous red line is intended to emphasise that stopping is prohibited. Unlike the prescribed bus stop clearway marking, with the broad continuous yellow line, taxis are not permitted to stop to pick up and set down passengers. Where taxis are to be allowed to use the bus stop clearway, the broad red line should be replaced by the red route double or single line as appropriate. The bus stop clearway should not operate for a shorter period than the red route controls.

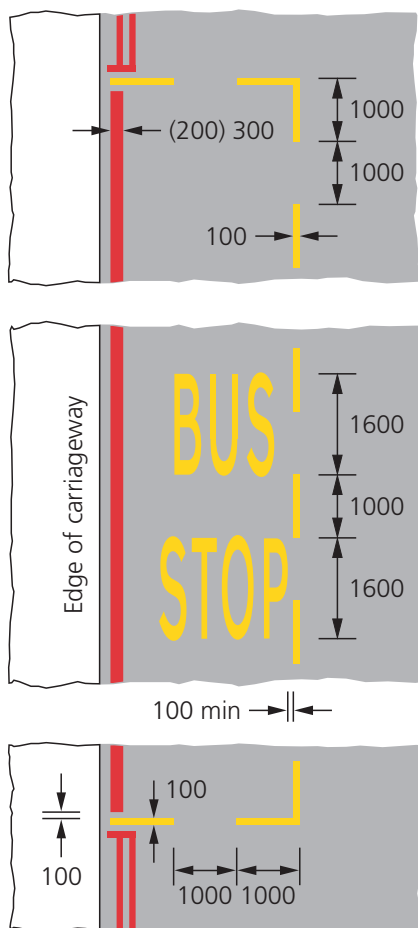

Figure 10-10 Bus stop clearway on red route

Used in conjunction with figure 10-11



Figure 10-11 No stopping on red route except buses

Used in conjunction with figure 10-10

10.9 Another type of red route is the “red route clearway”. This is similar to the 24-hour clearway described in section 9 except that, as for other red routes, it applies also to the verge and footway, not just to the main carriageway. No vehicle is permitted to stop at any time for any purpose, except in signed lay-bys. There is an exemption to allow taxis and disabled badge holders to pick up and set down passengers (see para 10.2). Where bus stops are required, the signs and road markings will be the same as those described in para 10.8, except that where taxis are permitted to use the bus stop, there will be no longitudinal lines running through the bay. The bay will need to be authorised in this case

because, without the broad yellow line, it is not prescribed by the Regulations. There are no other road markings, and the signing principles that apply to urban clearways (see paras 9.9 to 9.11) will apply to red route clearways. Where the speed limit is

higher than 30 mph, the 400 m spacing of signs between junctions should be increased proportionally so that drivers pass a sign approximately every 30 seconds (e.g. 800 m spacing at 60 mph). Figures 10-12 and 10-13 show the upright signs.



Figure 10-12 No stopping on red route clearway



Figure 10-13 End of red route clearway

11 PEDESTRIAN ZONES

GENERAL

11.1 Details of signs for roads, other than pedestrian zones, where either motor vehicles or all vehicles are prohibited can be found in section 5. Pedestrian zones are generally areas such as shopping streets where pedestrians will normally predominate and have full use of the width of the road, either at all times or at certain times of day. The roads may be fully paved for pedestrians or comprise a carriageway with separate footways.

11.2 Where alternative access to premises is available, it might be possible to prohibit all vehicles from a pedestrian zone without any exceptions. However, in most cases some form of access will be required. This might be for deliveries, disabled badge holders, buses etc. The pedestrian zone might operate for part of the day with or without exceptions, e.g. from 10 am to 4 pm, with unlimited access at other times. Alternatively, the zone might operate for a longer period, perhaps for 24 hours, with exceptions for access at certain times or at all times. Depending on the access requirements, a pedestrian zone might or might not need parking controls. It might be desirable to impose a prohibition of waiting and, possibly, loading during the hours when entry into the zone is prohibited. This would provide a means of enforcement where a vehicle has legally entered the zone and parked there but does not leave when the zone becomes operational. Where waiting and loading restrictions are needed, these should normally be signed and marked in accordance with section 6. However, if certain conditions are met, the road markings may be omitted and upright signs to diagram 637.2 provided (see paras 11.14 to 11.16).

11.3 Emergency vehicles, security cash delivery vehicles, road works vehicles, statutory undertakers' vehicles, domestic removals, funerals etc. are usually exempted from the traffic regulation order and are not signed as exceptions (see para 2.4).

ZONE ENTRY AND EXIT SIGNS

11.4 There are two types of entry sign: diagram 618.2 and diagram 618.3. The sign to diagram 618.3A is a variable message version of diagram 618.3. The exit sign to diagram 618.4 is used for all pedestrian zones. The sign to diagram 618.3, with the yellow "no waiting" panel, is intended mainly for pedestrian zones that have waiting restrictions

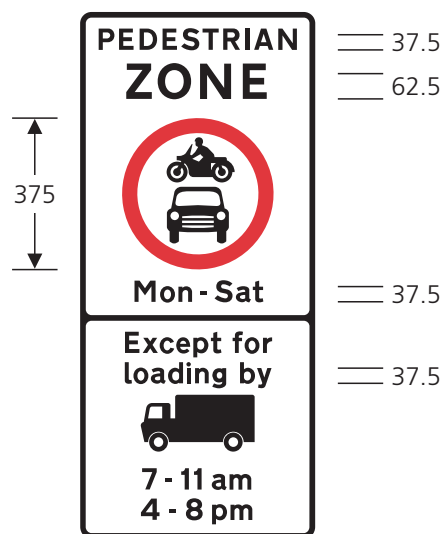
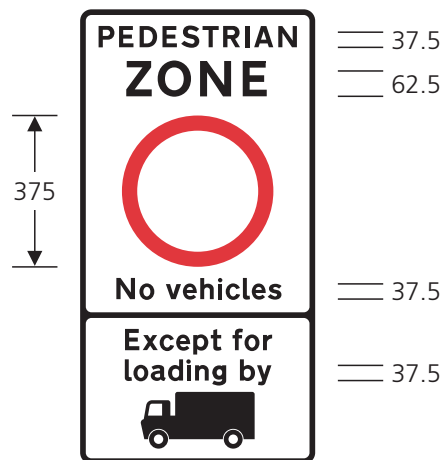

618.2 Entry to pedestrian zone restricted (Alternative types)

The time of day and days of the week may be varied or omitted. See table 11-1 for exceptions that may be shown in the lower panel

but no yellow lines, similar to the restricted zones described in section 13. The sign to diagram 618.2 has fewer variants indicating exceptions to the entry prohibition than the sign to diagram 618.3, and does not have a yellow "no waiting" panel. The sign to diagram 618.2 is used where there are no waiting restrictions within the zone because there are few or no exceptions to the prohibition of entry, or where waiting restrictions are signed in accordance with section 6. The sign to diagram 618.2 is therefore likely to be used for a pedestrian zone that operates for part of the day (e.g. 10 am to 4 pm) when all

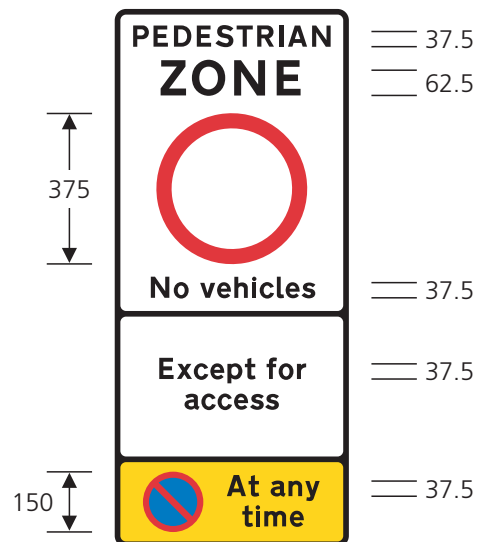
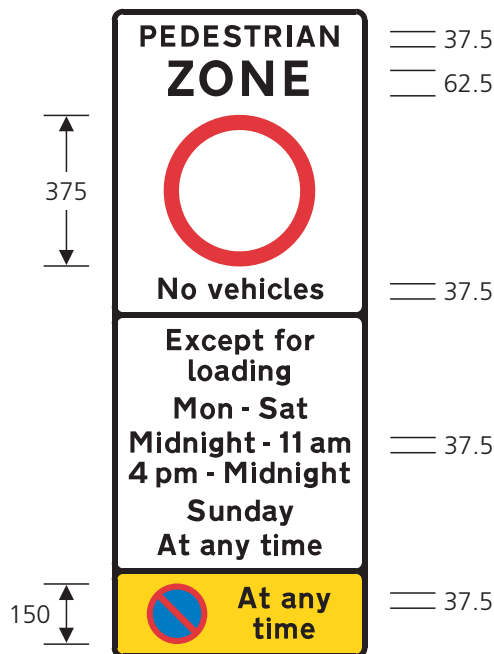
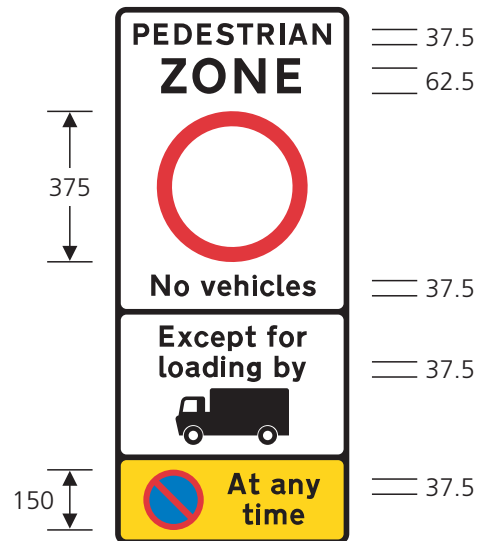
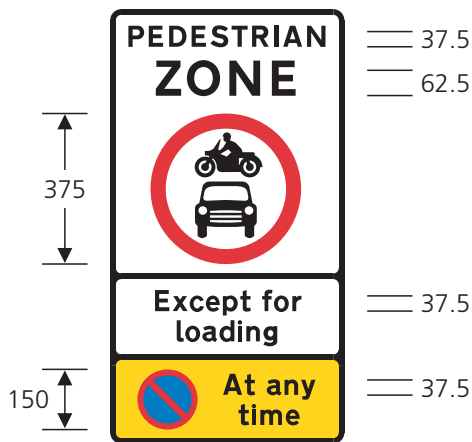

618.3 Entry to and waiting in pedestrian zone restricted (Alternative types)

618.3A Entry to and waiting in pedestrian zone restricted (Variable message sign)

The time of day and days of the week may be varied or omitted. See table 11-1 for exceptions that may be shown in the middle panel

The time period shown in the bottom panel may be varied. The diagram 617 roundel may be varied to the diagram 619 roundel and the words "No vehicles" omitted. See table 11-1 for exceptions that may be shown in the middle panel

vehicles are prohibited, and waiting restrictions are not required during that period. Where the waiting restrictions within the zone are too complex to be indicated on the sign to diagram 618.3, and where the sign to diagram 618.2 cannot be used because the exception is not prescribed for that sign (e.g. "Except for loading"), a special sign authorisation will be required (see para 2.1).

11.5 The upper panel of the entry sign will display the sign to diagram 617, with the legend "No vehicles" below, when ridden pedal cycles are not permitted within the zone. Where ridden pedal cycles are permitted, the upper panel will display the sign to diagram 619 (no motor vehicles). If ridden

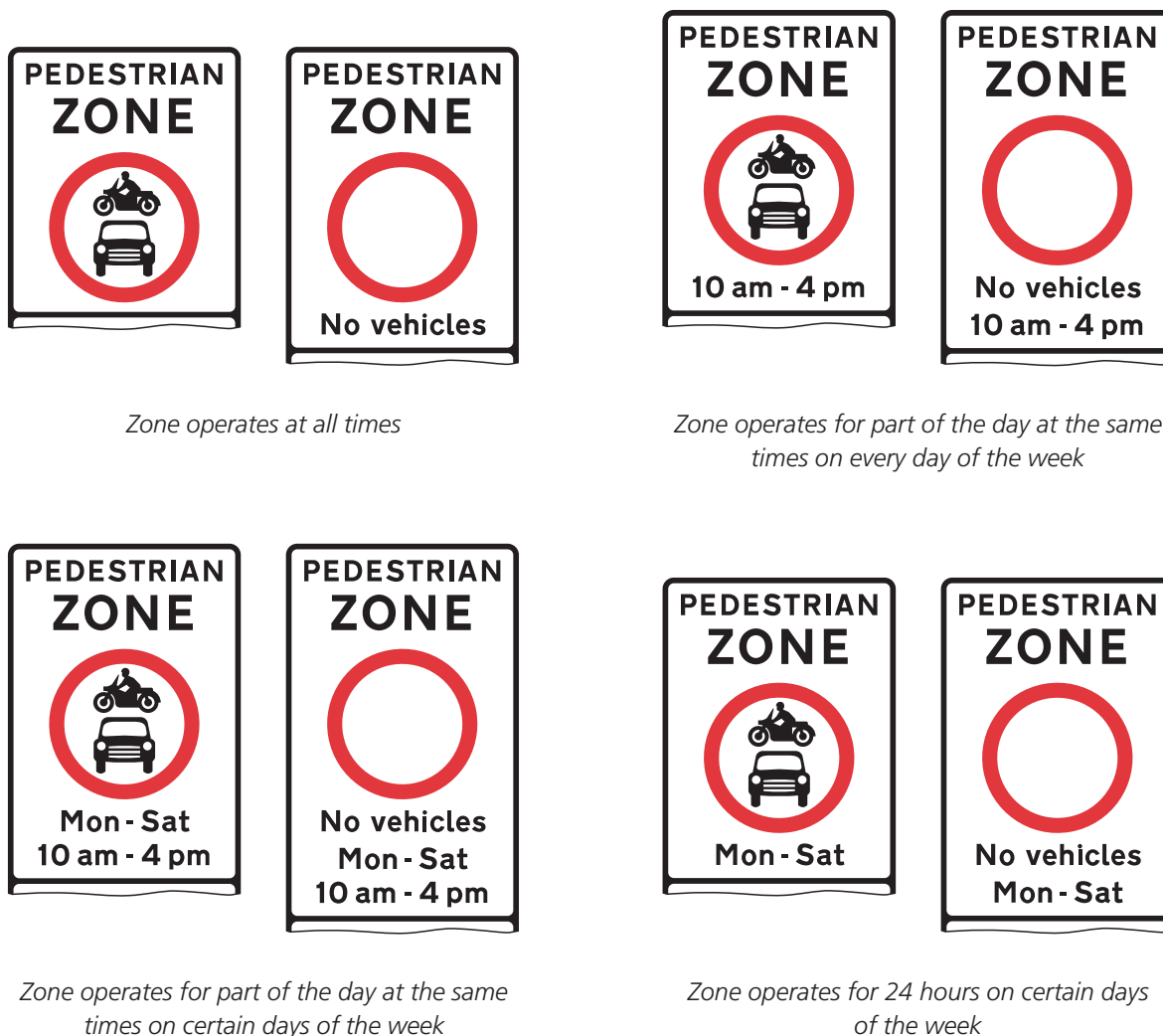

Figure 11-1 Examples of different times of operation for a pedestrian zone (diagrams 618.2 and 618.3)

pedal cycles are to be prohibited for only part of the time that the zone is operational, the entry sign will need special authorisation (see para 2.1).

11.6 Where the zone is operational for 24 hours on every day of the week, no times are shown on the sign other than those relating to the exceptions. If the zone is part time, the operational period is shown in the upper panel below the legend “No vehicles” or below the roundel to diagram 619 as appropriate. Where the zone operates only on certain days of the week and for 24 hours on those days, the days only are shown on the sign; the expression “At any time” is not used. Examples of the top panel for signs to diagrams 618.2 and 618.3 are shown in figure 11-1. The operational period is

not shown on the sign to diagram 618.3A as this is a variable message sign (see para 11.8).

11.7 The exceptions to the prohibition of entry that may be shown on signs to diagrams 618.2, 618.3 and 618.3A are set out in table 11-1. Because the sign to diagram 618.2 is likely to be used where there are no parking controls within the zone, it has fewer exceptions than the signs to diagrams 618.3 and 618.3A (see para 11.4). The more vehicles allowed in the zone, the greater the need to control parking. For example, where entry for loading by any vehicle is permitted, the prescribed sign is to diagram 618.3 or 618.3A and hence waiting restrictions are required; the bottom “no waiting” panel on these signs cannot be omitted without special authorisation. A time

Table 11-1 Permitted variants for exceptions shown on pedestrian zone entry signs

Permitted exceptions	Diagram 618.2	Diagram 618.3	Diagram 618.3A
No exceptions (omit panel - blank panel for diagram 618.3A)	YES	NO	YES
Except for loading	NO	YES	YES
Except for loading by <i>plus</i> goods vehicle symbol	YES	YES	YES
Except <i>plus</i> blue badge symbol (disabled badge holders)	YES	YES	YES
Except permit holders <i>plus</i> identification symbol where appropriate	YES	YES	YES
Except buses	YES	YES	YES
Except local buses	YES	YES	YES
Except taxis	NO	YES	YES
Except for access	NO	NO	YES

NOTE: The exceptions shown in the table, where permitted for a particular sign, may be combined except that (a) "for loading" must not be used with "for loading by" plus the goods vehicle symbol, (b) "buses" must not be used with "local buses", and (c) "for access" must not be used with "for loading" or with "for loading by" plus the goods vehicle symbol. The word "and" shall be inserted before the last variant.

period indicating when the exceptions apply (if different from the zone operational period) may be added to diagrams 618.2 and 618.3. It is recommended that where more than one exception is shown on the sign, each applies for the same time period, otherwise the sign becomes complex and difficult for a driver to assimilate. If different time periods are required for each exception, it is likely to be more appropriate to use the variable message sign to diagram 618.3A. The design of the exception panel is shown on the appropriate working drawings (see para 1.9). **Note that the panel dividers are always the same width as the sign border.**

11.8 If the restrictions change during the day or on different days of the week, a variable message sign to diagram 618.3A is recommended to avoid complex legend that can be confusing and difficult to read. These can be simple flap-type signs or automatically timed rotating planks or prisms. Light-emitting variable message signs are not normally suitable for this type of sign. The sign should show a complete blank grey or black face, as prescribed by regulation 58(1), during the times when the zone is not operational. The bottom panel cannot be shown by itself, nor can it be omitted when the other parts of the sign are being displayed. Where waiting restrictions apply for a period longer than the zone operational period, they should be indicated by signs

and markings within the zone in accordance with section 6; they are shown in the bottom panel of the sign to diagram 618.3A only when the zone is operational.

11.9 During the period that entry into the zone is prohibited, the centre panel of the sign to diagram 618.3A may be varied at different times of day to show the appropriate exceptions. This panel has a fixed size which is determined by the tallest legend to be shown. When there are no exceptions, the panel should have a white background with no legend. The permitted variant "Except for access", on its own or combined with another exception, should not be displayed for the whole period the zone is operational. It is likely that this would attract too many vehicles and could compromise pedestrian safety. It could also make parking enforcement difficult in fully paved roads where yellow lines are not provided (see paras 11.14 and 11.15). General access should be permitted only at times when it is deemed essential. Where access is required at all times, the road should be signed in accordance with section 5 and not as a pedestrian zone. It should be noted that "Except for access" is not a permitted variant of either diagram 618.2 or 618.3. A disadvantage of using a variable message sign is that it does not inform drivers when the period during which access is permitted comes to an end.

11.10 Only one size of zone entry sign is prescribed, although the overall height will vary according to the time periods and exceptions shown. The signs must be sited in accordance with direction 8 as described in para 1.19. Normally two entry signs will be required, but where para 1.19(iii) might apply (i.e. only one entry sign is required) and the road is fully paved, the carriageway width should be taken as the width that is available to vehicles entering the road. This will depend on the nature of the paving and the presence of any obstacles such as planters and trees.

11.11 Where the pedestrian zone comprises a one-way road, it should be signed in accordance with paras 4.35 to 4.43. Signs to diagram 618.2, 618.3 or 618.3A should be provided only at the entry to the zone in the direction of travel; they should not be used with or in place of the “no entry” signs to diagram 616 at the other end of the one-way road.

11.12 Where all motor vehicles are prohibited from a pedestrian zone and there are no exceptions, an alternative to the provision of zone entry signs is to physically prevent vehicles from entering. This can be achieved by the placing of barriers, bollards, street furniture, planters etc. Where it is necessary to maintain access for emergency vehicles or where the total prohibition of vehicles does not apply at all times, any physical obstruction should be removable. Signs to diagram 606, 617 or 619 may be used to supplement any barriers, but “no entry” signs to diagram 616 should not be used; these are appropriate only in one-way streets. It might be possible to permanently close one end of a pedestrian zone so that it is no longer available to through traffic. Places where emergency vehicles may enter a 24-hour zone without having to open a barrier should be sited so as to discourage other vehicles from entering.

11.13 The zone end sign to diagram 618.4, which is prescribed in one size only, should be sited as close as practicable to the point where the prohibition ends. Although there is no specific requirement to provide the sign, it is helpful to both pedestrians and drivers, particularly where the pedestrian zone has a carriageway and separate footways, as it indicates that normal traffic conditions resume. Where it is clear that a fully paved road has come to an end, and there are very few exceptions to the prohibition of vehicles, it might not be necessary to provide an end sign. Where a sign is provided, the roundel shown in the upper panel will be a grey-coloured version of that shown on the entry sign. Where the roundel is

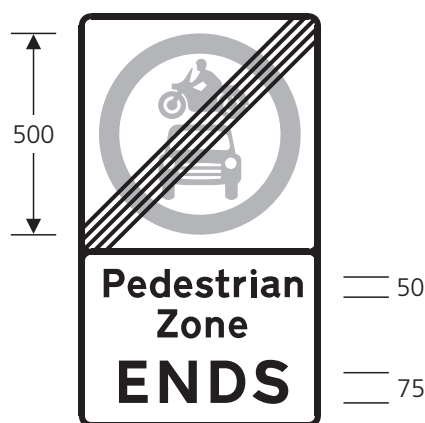

618.4 End of restrictions associated with a pedestrian zone

The diagram 619 symbol may be varied to a grey symbol to diagram 617

to diagram 617, the legend “No vehicles” must not be used on the end sign.

SIGNS WITHIN THE ZONE

11.14 Where there is a prohibition of waiting within a pedestrian zone, this should normally be signed in accordance with section 6. However, as an alternative, signs to diagram 637.2 may be used, together with yellow lines to diagram 1017 or 1018.1, to emphasise that the street is within a pedestrian zone (see para 11.17). In this case, the zone entry sign must be to diagram 618.3 or 618.3A (direction 24(3)). Yellow lines need not be used within the zone provided certain conditions are met (direction 24(4)). These conditions are:

- (i) The upright sign must be to diagram 637.2 and not 637.3, 639, 639.1B or 640. (The zone entry sign must therefore be to diagram 618.3 or 618.3A.)
- (ii) The road must not comprise a carriageway and footway which are separately defined
- (iii) The prohibition of waiting must be at the same times as the prohibition of vehicles as shown on the entry sign. (The time period shown on the bottom panel of a sign to diagram 618.3 or 618.3A must be the same as that shown on the sign to diagram 637.2.)

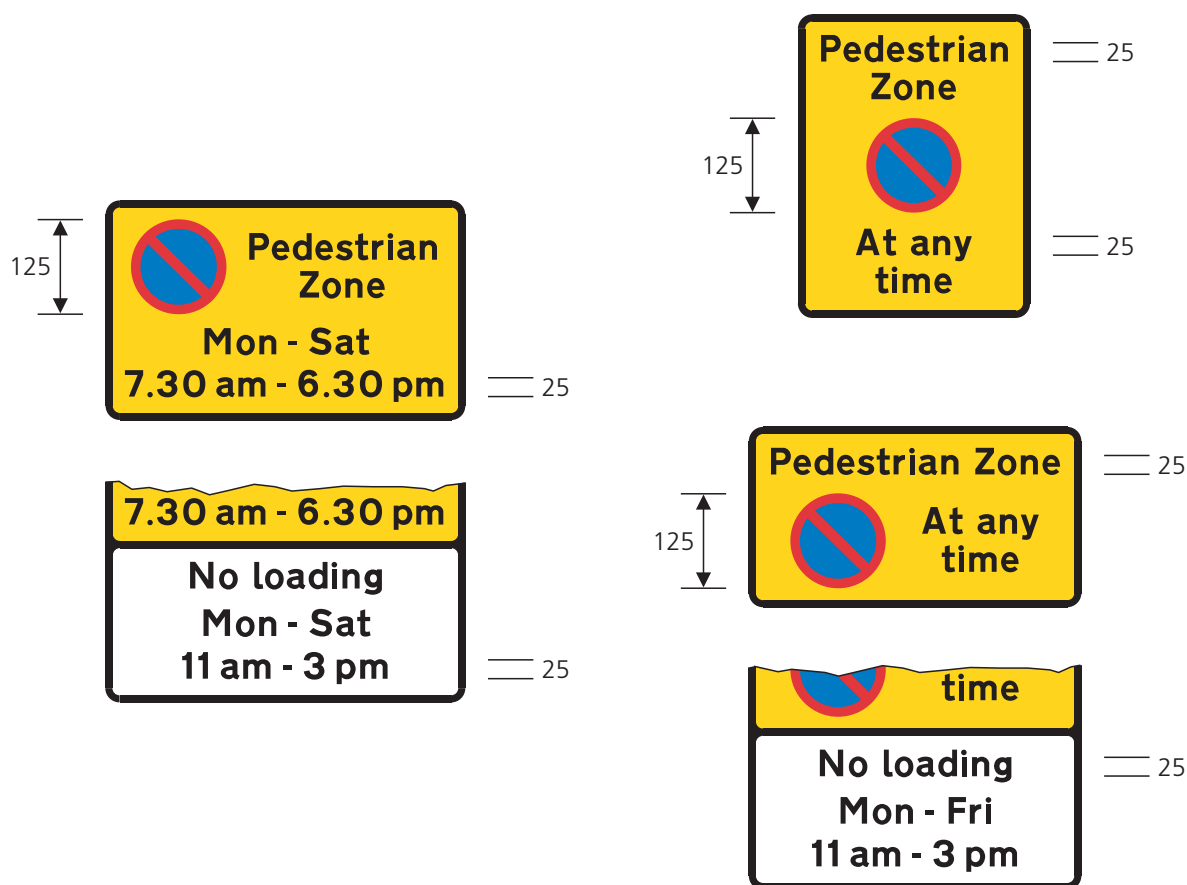

637.2 Prohibition of waiting and loading in a pedestrian zone
(Alternative types)

The time periods may be varied. The panels indicating the prohibition of loading may be varied to diagram 638

- (iv) The prohibition of waiting must apply uniformly throughout every road in the zone.

11.15 In many cases, not all the conditions required for dispensing with yellow lines will be met. For example, a road might be fully paved, but have the appearance of comprising a separate carriageway and footway. Another situation is where the pedestrian zone does not operate for 24 hours and during the times the road is open to all traffic a prohibition of waiting is required. Depending on the particular circumstances, it might still be desirable and practicable to dispense with yellow lines as in restricted zones (see section 13). Where this is the case, the Department, if in agreement, will issue a special direction to a traffic authority to permit this.

11.16 Where a prohibition of loading is required, this may be indicated by the two-panel version of diagram 637.2, provided the zone entry signs are to either diagram 618.3 or 618.3A. The entry signs do not indicate the loading prohibition as they do the prohibition of waiting; they show only the periods when access for loading is permitted. Yellow kerb marks to diagram 1019 or 1020.1 need not be used within the zone where the conditions described in para 11.14, but applying to a loading ban, are met (direction 24(4)). Where access to the zone is permitted at certain times for the purposes of loading, the times shown on the lower panel of the sign to diagram 637.2 should be consistent with those shown on the centre panel of the entry sign to diagram 618.3; examples are shown in figure 11-2. If the entry sign is a variable message sign to

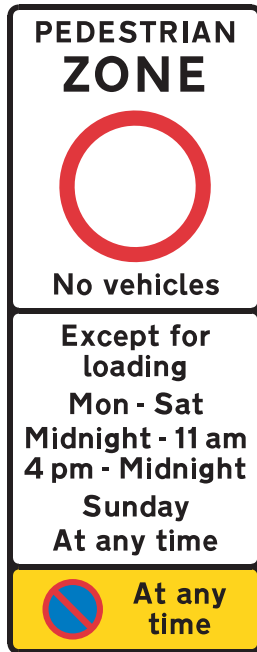

Figure 11-2 Examples of pedestrian zone entry sign and associated sign within the zone (where there are no yellow lines indicating waiting and loading restrictions)

diagram 618.3A, the loading prohibition shown on the sign to diagram 637.2 should relate to the period when the zone is operational, but the centre panel is blank. Where access is permitted for disabled badge holders or permit holders, any loading ban operating at the same time (e.g. to prevent parking in certain areas) will need to be fully signed and marked. Where the conditions for dispensing with kerb marks are not fully met, but it is considered desirable to omit the markings, the Department, if in agreement, will issue a special direction to a traffic authority to permit this.

11.17 Where the prohibition of waiting within a zone is continuous and indicated by double yellow lines, upright signs are not required unless there is a prohibition of loading. Where the prohibition of waiting is indicated by single yellow lines and the entry sign is to diagram 618.3 or 618.3A, the sign to diagram 637.2 could be used instead of the signs described in section 6, provided that the waiting restrictions do not apply outside the operational period of the pedestrian zone.

11.18 Where full signing of waiting and loading restrictions is provided in accordance with section 6, the zone entry sign may be to diagram 618.2. Where the times of the prohibition of waiting vary within the zone, an entry sign to either diagram 618.3 or 618.3A is not appropriate because the bottom panel cannot indicate the variation. In these circumstances the entry sign should be to diagram 618.2. However, should access be required for loading or for taxis, i.e. exceptions which are not permitted variants of diagram 618.2, traffic authorities must seek authorisation from the Department for the lower

panel to be omitted from either diagram 618.3 or 618.3A. This will be considered only where full signing and marking of the prohibition of waiting and loading is to be provided.

11.19 The sign to diagram 637.2 is prescribed in one size only. Where road markings are provided, signs should be sited in accordance with para 6.34. Note that arrows cannot be added to the sign and therefore the first sign should be sited within 15m of where the restriction starts, but not at the commencement. Where signs are used without road markings, they should be placed strategically rather than at fixed intervals. The aim should be that wherever drivers might be tempted to stop, they can see a sign. The spacing between consecutive signs, whether or not they are on the same side of the road, should be no more than 30m. They may be mounted on lamp columns or separate posts. Alternatively, it might be possible to mount the signs on walls. Where posts are used in a fully-paved pedestrian area, these might best be located close to buildings where they are least likely to obstruct pedestrians. The posts may be of any single colour, which could be chosen to blend in with the adjacent building. In roads where bollards have been provided, these might offer convenient mounting points. However, they will not usually be wide enough to accommodate a sign. Low mounting also risks obscuration by pedestrians. Any projecting edges are soon damaged and can present a hazard to pedestrians, especially children. The Regulations do not permit signs to be curved around bollards. This reduces conspicuity and makes the legend more difficult to read. Signs may be curved only when this is a permitted variant, e.g. diagram 561.

12 CONTROLLED PARKING ZONES

GENERAL

12.1 There are two types of controlled parking zone (CPZ); these are defined in regulation 4 as follows:

“controlled parking zone” means either –

- (a) an area –
 - (i) in which, except where parking places have been provided, every road has been marked with one or more of the road markings shown in diagrams 1017, 1018.1, 1019 and 1020.1; and
 - (ii) into which each entrance for vehicular traffic has been indicated by the sign shown in diagram 663 or 663.1; or
- (b) an area –
 - (i) in which at least one of the signs shown in diagram 640.2A has been placed on each side of every road; and

- (ii) into which each entrance for vehicular traffic has been indicated by the sign shown in diagram 665.

The first type of CPZ, defined in (a), is an area comprising a prohibition of waiting by all vehicles. It may include designated parking places. The second type of CPZ, as defined in (b), is an area in which there is a prohibition of waiting by commercial vehicles (goods vehicles and buses), usually overnight. It does not have any road markings associated with it.

12.2 Both types of CPZ have zone entry signs which show the times that waiting is prohibited (but see para 12.7). For a type (a) CPZ, these times may be the same as the operational period of the on-street parking places within the zone. This is always the case for voucher parking zones and other CPZs where the type of parking is indicated on the entry sign (see para 12.5). Signing within a type (a) CPZ will generally be in accordance with section 6 for waiting and loading prohibitions and section 7 for parking places. However, where waiting restrictions operate only during the times shown on the entry

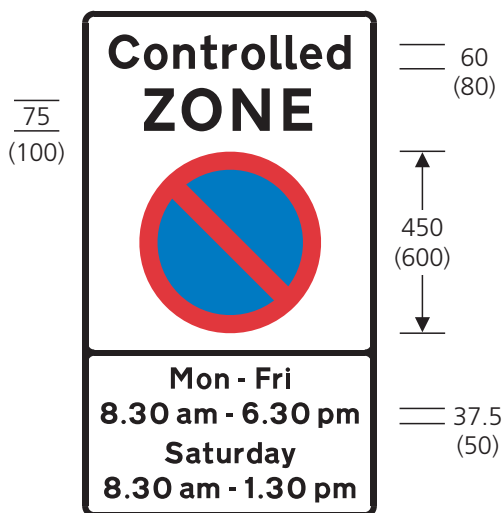

663 Entrance to a controlled parking zone

“Controlled” may be varied to “Meter”, “Disc”, “Ticket”, “Disc and Meter”, “Ticket and Meter” or “Pay and Display”. The name of the zone or a zone identifier may be added. The name of the traffic authority may be added. The legend “No loading” may be added below the no waiting roundel. The time period may be varied. The lower panel of the sign shall be omitted where, **and only where**, the restrictions apply at all times

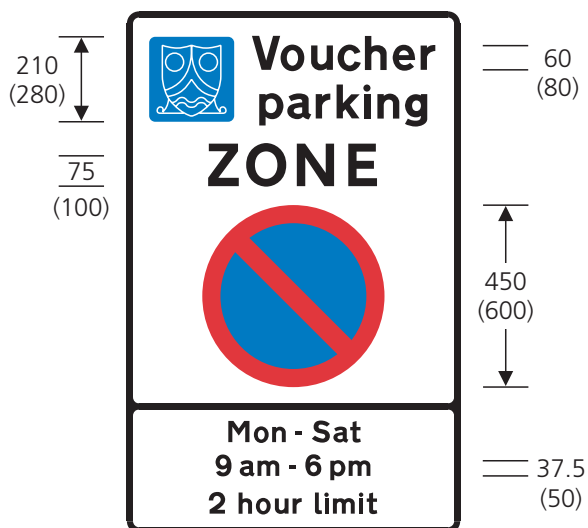

663.1 Entrance to a voucher parking zone

The voucher parking symbol is to be varied to correspond with the voucher design within the size shown. The name of the zone or a zone identifier may be added. The name of the traffic authority may be added. “Voucher parking” may be varied to “Voucher parking and Meter” or “Voucher parking and Ticket”. The legend “No loading” may be added below the no waiting roundel. The time periods may be varied or omitted

sign, upright signs to indicate these times within the zone are not normally required (direction 25(2)); this is one of the reasons for introducing a CPZ (see para 12.8 for a detailed appraisal of the advantages and disadvantages). It is possible that within a type (a) CPZ there will be some lengths of road that have a prohibition of waiting at different times from those shown on the entry sign, in which case upright signs must be provided unless the prohibition is “no waiting at any time” (see para 6.6). It is strongly recommended that where the zone does not operate at all times, waiting restrictions indicated by single yellow lines should not be more onerous than those shown on the entry signs, especially near entry points to the zone, as this might be confusing to drivers who are not expecting any restrictions (other than double yellow lines) to apply outside the control times of the zone. Where there is a prohibition of stopping on entrance markings within the zone, it might be necessary to sign the waiting restrictions also (see para 9.17).

12.3 Where loading is prohibited within a type (a) CPZ, this may be indicated on the entry sign (see para 12.7), but only if the times are the same as those for the prohibition of waiting. If the loading prohibition operates at different times, it must be signed within the zone. Where an area has roads that are predominantly “no waiting at any time” and loading is not prohibited at all times, there may be little advantage in designating the area as a CPZ and providing zone entry signs (see para 12.8).

12.4 All designated parking places and loading bays within a type (a) CPZ, other than parking meter bays, need to be signed in accordance with section 7 (see para 12.23 for disc or ticket parking). The times of operation, where not continuous, are always shown on the sign, even where they are the same as those shown on the zone entry sign. To omit times from the sign indicates that a parking place or loading bay operates at all times. Where the parking bays operate for a shorter period than the CPZ (e.g. the CPZ operates from 8 am to 6 pm, and the parking bays from 10 am to 4 pm), a sign to diagram 639.1B should be used (see paras 7.30 to 7.32). This is because the waiting restrictions are different from those shown on the entry sign, i.e. they do not apply when the parking bay is operational. The sign also ensures that drivers are aware of all the restrictions.

12.5 The entry sign for a type (a) CPZ is to diagram 663, except for a voucher parking zone where the appropriate sign is to diagram 663.1 (see paras 7.24

to 7.26 for details of voucher parking schemes). The legend at the top of the sign to diagram 663 can be varied to indicate the type of parking within the zone. In most cases this will be “Controlled ZONE”, as it covers all types of parking other than disc and ticket parking. It is also used for those zones that have no on-street parking places. Where on-street parking is of the same type throughout the zone, whether or not permit parking is also provided, and where the operational time of the parking places is the same as the times shown on the entry sign (see para 12.2), the legend on the sign may be one of the following:

- (i) Meter ZONE (where parking meters are used)
- (ii) Pay and Display ZONE (on-street ticket machines)
- (iii) Ticket ZONE (purchase of ticket other than from an on-street machine)
- (iv) Disc ZONE (limited waiting requiring the display of a parking disc to indicate the time of arrival).

Additionally, “Disc and Meter ZONE” and “Ticket and Meter ZONE” may be used as appropriate. If the CPZ includes disc or ticket parking, the upright signs within the zone indicating the parking places will be to diagram 662. As this sign includes the legend “Disc Zone” or “Ticket Zone”, the entry sign must show “Disc ZONE”, “Ticket ZONE”, “Disc and Meter



662 Parking place within a disc or ticket zone

May be used only in conjunction with the marking to diagram 1028.4, 1032 or 1033, in each case when no legend appears. An arrow may be added pointing to the left or to the right. The time periods may be varied. The name of the traffic authority may be added. “Disc” may be varied to “Ticket”

ZONE" or "Ticket and Meter ZONE". It is therefore not appropriate to mix disc or ticket parking with any other type of parking that is available to non-permit holders (e.g. pay and display). A zone signed with any of the permitted legends may include parking for permit holders and for disabled badge holders.

12.6 The legend at the top of the voucher parking zone sign may be varied to either "Voucher parking and Meter ZONE" or "Voucher parking and Ticket ZONE". This zone may also include parking for permit holders and disabled badge holders, although not indicated on the entry sign.

12.7 The legend "No loading" is added below the roundel on the signs to diagrams 663 and 663.1 where there is a prohibition of loading within the zone that applies at the same times as the prohibition of waiting (see para 12.3). Where the zone operates at all times, the lower panel of the sign to diagram 663 is omitted (whether or not "No loading" is indicated in the upper panel of the sign). The lower panel of the sign to diagram 663.1 is not omitted, as it needs to show the maximum period that parking is allowed in one visit. The operational period shown on either sign may not be varied to "At any time" as this is not permitted by the Regulations.

12.8 It is not essential for a type (a) CPZ, other than a disc or ticket zone, to be introduced where parking controls are required. Each road can be signed in accordance with sections 6 and 7 without the need to provide zone entry signs. The advantages of a zone might be:

- (i) a simplified traffic order
- (ii) some reduction in environmental intrusion by removal of upright "no waiting" signs and posts within the zone (see para 12.2), but at the expense of providing large zone entry signs
- (iii) an indication to drivers that all road space is controlled
- (iv) an indication to drivers of the type of parking available (e.g. pay and display).

However, there are also significant disadvantages. Research has shown that it is unrealistic to expect drivers to remember the times of operation of the

zone when they come to park a considerable distance after passing a zone entry sign. The area of the zone should therefore be restricted to, for example, a town centre shopping area. A zone covering a whole town, or suburb of a conurbation, would be much too large (see para 12.13). Drivers are likely also to have difficulty where zones have complex operational times, e.g. different times on different days of the week, or where they are adjacent to other zones that have different operational times. In all the above cases, consideration should be given to replacing the zone with conventional signing as described in section 6, dividing the zone into several smaller ones or reducing the size of the zone and signing other roads individually.

12.9 As the times shown on the entry signs generally coincide with those applying to parking places as well as to the yellow line waiting restrictions, drivers might take signs at on-street parking places as a reminder of the times when waiting is prohibited. This would be confusing where parking places operate at different times (e.g. 24-hour permit parking in a zone that does not operate for 24 hours). In such cases, conventional signing might be preferable to the introduction of a zone.

12.10 Where there are breaks in a run of parking bays to allow for vehicle crossovers at private accesses, the Regulations require that these gaps be marked with a yellow line (see para 12.1). This must be reflected in the order, as a yellow line cannot be placed within a designated parking place (i.e. the vehicle crossovers must be specifically excluded from the parking place defined in the order). A yellow line at a vehicle crossover would prevent the owner of a property from parking there when the waiting restriction is in force. If this is a problem, a possible solution might be to extend the bay across the access, which should be included in the order as part of the designated parking place, but provide the advisory "keep clear" marking to diagram 1026.1 to discourage inconsiderate parking (see para 7.52). Where the road is a cul-de-sac and all parking is for permit holders only, the signing described in para 7.15 might be appropriate, but this will require authorisation from the Department (see para 2.1). In this case there would be no road markings within the road concerned, but as it would be designated as a parking place for permit holders, it would still meet the requirements of a type (a) CPZ as defined by the Regulations (see para 12.1).

12.11 Where a length of road within a type (a) CPZ has both a prohibition of waiting that would normally be indicated by a single yellow line without upright signs (see para 12.2) and a prohibition of waiting by commercial vehicles indicated by the sign to diagram 640.2A (see paras 6.18 to 6.20 and 12.15 to 12.18), drivers might associate the sign with the road marking. As the two restrictions are likely to apply at different times, it is recommended that signs to diagram 639 or 640, co-located with each sign to diagram 640.2A, are provided to supplement the yellow line.

12.12 The end of a type (a) CPZ is indicated by the sign to diagram 664. Where one zone ends and another commences, the zone end sign is replaced by the zone entry sign for the second zone. Where a road forms the boundary between two zones, it should be within one or the other zone, or excluded from both; one side of the road should not be within one zone and the other side within the other zone, as this would result in signing that is likely to be confusing to drivers.

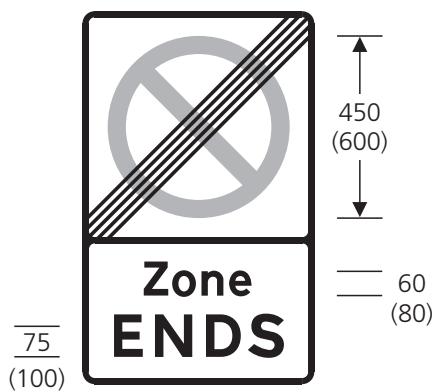

664 End of a controlled zone indicated by a sign to diagram 663 or 663.1

12.13 The extent of a type (a) CPZ will be determined by specific characteristics. For example, the zone could be an area where a specific parking permit is valid (see paras 7.10 to 7.15). An appropriate zone identifier may be added to the entry sign as shown on drawing P 663. The zone might be an area where the type of parking, such as pay and display (possibly with uniform charges), is the same throughout. Where the parking is time-limited with no charge (see paras 7.8 and 7.9), the prohibition on return to the parking place might be applied to the whole zone. This would be appropriate only for small

zones, as it would be unreasonable to expect drivers not to return to any part of a large area; enforcement would also be difficult. The signs located at the parking bays in this type of zone would include the legend “No return to Zone A within 2 hours” (or similar), and would be based on the sign to diagram 661.1 (see para 7.8) or, if it is a disc zone, the sign to diagram 662. Such signs would require authorisation from the Department (see para 2.1) as they are not prescribed by the Regulations in this format. Again the zone identifier would be shown on the entry sign and would also apply to any permit parking within the zone. In an area with a mix of different types of parking, a zone could represent a small geographical area, the name of which may be added to the entry sign as shown on working drawing P 663 (see para 1.9).

12.14 A type (a) CPZ may be introduced to control parking within the vicinity of a sports stadium or similar facility (see para 7.41). This might be an independent zone that operates only when an event is taking place; on other days there are no zonal controls. An existing zone that operates throughout the year could have additional controls on event days; this makes the zone entry sign very complicated and should be avoided where possible. In such circumstances, all yellow line waiting restrictions within the zone should have upright signs showing times when waiting is prohibited, both on event days and on non-event days. Signs indicating parking controls on event days are not prescribed and require authorisation from the Department (see para 2.1). Additional signs should normally be provided on the approach to the zone, indicating the date of the next event, where it is not possible to include this information on the zone entry sign. These signs also require authorisation.

PROHIBITION OF WAITING BY GOODS VEHICLES AND BUSES

12.15 The sign shown in diagram 665 indicates the boundary of a type (b) CPZ (see para 12.1). The times shown on the sign usually indicate an overnight period. The sign can therefore be simplified if the prohibition applies at the same times on every day of the week, e.g. 7 pm - 8 am, without the need to refer to midnight. As this type of zone can be used only to prohibit waiting by large vehicles, the entry signs (and those within the zone) cannot be varied to include a prohibition of loading.

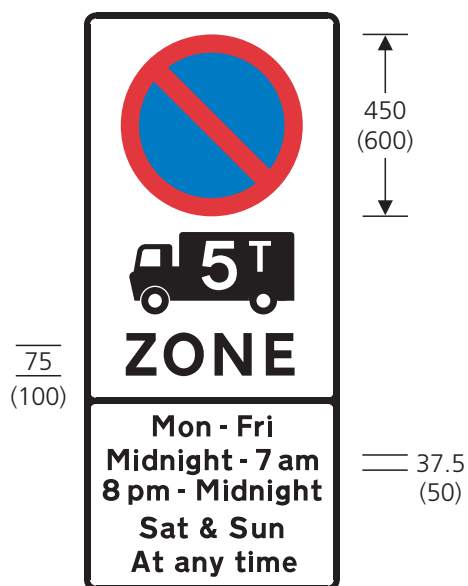

665 Entrance to a goods vehicle parking zone

The time period may be varied. "5T" may be varied to "7.5T". The bus symbol shown in diagram 952 may be added below or substituted for the lorry symbol

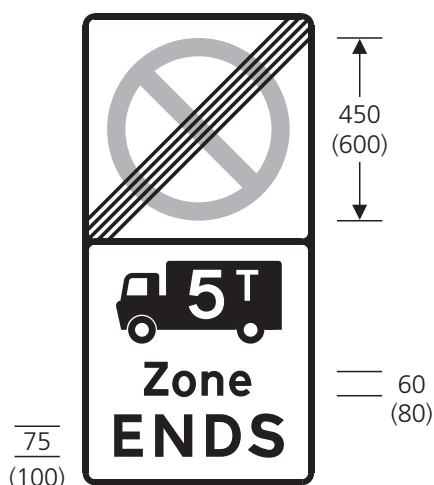

666 End of a goods vehicle parking zone

"5T" may be varied to "7.5T". The bus symbol shown in diagram 952 may be added below or substituted for the lorry symbol

12.16 A type (b) CPZ can apply to goods vehicles, buses or both as indicated by the appropriate symbols on the signs. The lorry symbol may show a maximum gross weight of either 5 tonnes or 7.5 tonnes; any other weight would require authorisation from the Department (see para 2.1).

12.17 Signs to diagram 640.2A are provided within the zone (see paras 6.18 to 6.20). There should be at least one sign on each side of every road (see para 12.1). Road markings are not used. Where there are other waiting restrictions indicated by the marking to diagram 1017 (single yellow line) within the zone, it is recommended that the upright signs for these are co-located with the sign to diagram 640.2A to avoid driver confusion (see also para 12.11).

12.18 The exit from the zone is indicated by the sign shown in diagram 666. The symbols shown in the lower panel must be the same as those shown on the entry sign.

SIGN DESIGN, SIZE AND SITING

12.19 The detailed design of zone entry and exit signs for both types of CPZ is set out on the appropriate working drawings (see para 1.9). **Note that the panel divider is always the same width as the sign border.** The voucher symbol on the entry sign to diagram 663.1 must be the same as that shown on the signs to diagram 660.5 within the zone, and correspond to the design shown on the vouchers themselves (see para 7.25). The symbol must be within the size shown in diagram 663.1. The design of the sign shown in diagram 662, including permitted variants, is detailed on working drawing P 662 (see para 1.9). This is similar to the sign shown in diagram 661.1 (see para 7.8) with the additional legend "Disc Zone".

12.20 There are two sizes of entry and exit signs. The smaller size would normally be used where the zone boundary is in a side road at a junction or on a minor through-route with low traffic speeds. The larger size entry sign is appropriate where the zone boundary is on a main road with a speed limit of 30 mph or more. It might also be used where there is a need to give drivers more time to assimilate the information, e.g. where the time period shown is complex (although this should be avoided wherever possible).

12.21 Zone entry signs for both types of CPZ, facing approaching traffic, must be placed on each side of the road or on each side of the appropriate carriageway of a dual carriageway road at every entry point. If the road is a side road at a junction and is less than 5 m wide, one zone entry sign might be sufficient (see direction 8 and para 1.19). The boundary of a zone, particularly on a main through road, should be carefully chosen so that the entry sign is not in conflict with other traffic signs, traffic signals, pedestrian crossings etc. which demand a driver's attention. Locations where the zone entry signs are likely to be obscured by large vehicles (e.g. delivery vans, or buses at bus stops) should be avoided. The zone end sign, when placed on a two-way road, will normally be mounted back to back with the entry sign.

12.22 The choice of x-height, the siting of signs and the provision of road markings for waiting and loading restrictions within a type (a) CPZ should be in accordance with section 6. Signs indicating a prohibition of waiting or a prohibition of loading may be omitted where these prohibitions operate at the same times as shown on the zone entry sign (see para 12.2). The choice of x-height for the sign to diagram 640.2A within a type (b) CPZ should also be in accordance with section 6 (see para 6.33).

12.23 The choice of x-height, the siting of signs and the provision of road markings for parking places within a type (a) CPZ should be in accordance with section 7. For disc or ticket zones, the sign to diagram 662 is used in a similar manner to the sign shown in diagram 661.1 (see para 7.8), except that it cannot be used to indicate a parking place for a particular class of vehicle such as a bus. The bay marking used with diagram 662 is diagram 1028.4, 1032 or 1033, in each case without any legend.

13 RESTRICTED PARKING ZONES

GENERAL

13.1 Restricted parking zones were originally developed for areas where very narrow roads resulted in conventional yellow lines being visually intrusive. Zones are now also used in urban areas and town centres where it is desired to enhance the environment, for example by improved road surface treatment, but where it is not appropriate to implement a full pedestrian zone (see section 11). They have also been used in some residential areas.

13.2 Waiting and loading restrictions, which must be uniform throughout the zone, are indicated by zone entry signs and time plates within the zone, but without yellow lines or kerb marks. Restricted parking zones are therefore suitable only for single streets or clearly defined small areas. They are not suitable for through routes with heavy traffic or facilities which create a demand for parking greater than can be accommodated in the on-street bays (unless convenient off-street parking is available). Unlike a pedestrian zone, there is no restriction on entry into a restricted parking zone.

13.3 Provision may be made for parking and loading within a zone, with bays being delineated either by white road markings or by physical features such as block paving, planters, bollards etc. Upright signs for such bays will generally be prescribed and be in accordance with the signs described in section 7. However, where uncontrolled parking is provided this will need to be indicated by specially-authorized signs. For example, in a 24-hour zone (no waiting at any time) a parking bay might be pay and display during the day, with free (uncontrolled) parking overnight (see para 13.10).

13.4 Zone entry and end signs, and repeater signs for the waiting and loading restrictions, are not prescribed by the Regulations and require authorisation by the Secretary of State (see para 2.1). Other signs within the zone might also require authorisation (see paras 13.3 and 13.8 to 13.11). Where prescribed signs are used for on-street parking places or loading bays but without the associated prescribed road marking, a special direction will be required from the Secretary of State. Traffic authorities should discuss proposals with the Department before submitting an application for authorisation.

ZONE ENTRY AND EXIT SIGNS

13.5 The zone entry sign is based on the controlled parking zone sign to diagram 663, as shown in section 12, with the legend at the top of the sign varied to "Restricted ZONE". Design details are shown on working drawing NP 663.2, available on request from the Department. Figure 13-1 shows a typical example of a sign for a zone where there are no parking or loading facilities. Where the sign indicates a time period less than 24 hours, no

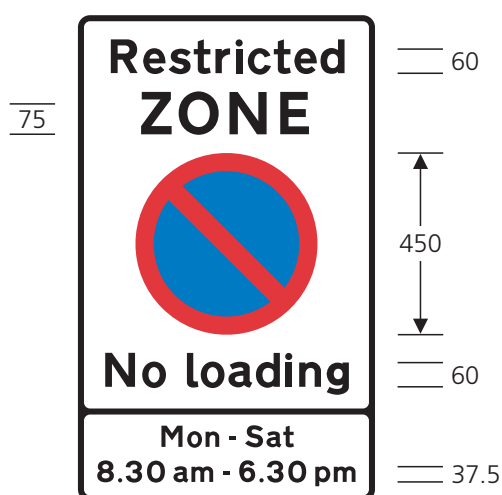

Figure 13-1 Entry to a restricted parking zone with no on-street parking or loading facilities during the times shown

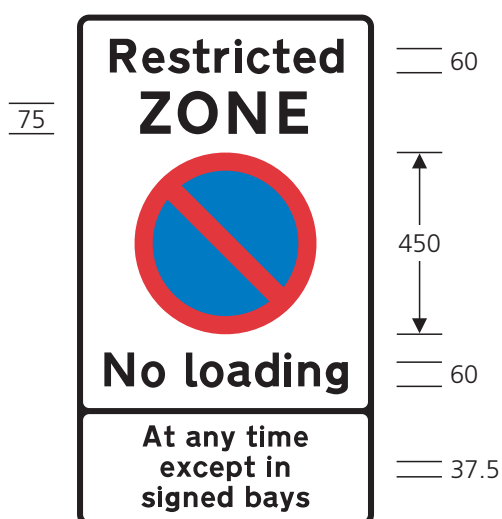

Figure 13-2 Entry to a restricted parking zone with provision for parking or loading in signed bays

controls are to be applied outside that period. Where the prohibition of loading applies for a period shorter than that for the prohibition of waiting, the legend "No loading" is omitted. The loading prohibition will then be signed only within the zone (see para 13.8). Where there is some provision of on-street parking or loading within the zone, this is indicated on the entry sign by the legend "except in signed bays" as shown in figure 13-2.

13.6 Zone entry signs are not prescribed by the Regulations, but for siting purposes they should be treated in a similar manner to controlled parking zone signs as described in para 12.21. Drivers need to be alerted to the fact that they are entering a special area where there is a prohibition of waiting without yellow lines. In addition to the careful siting of entry signs, a road surface feature such as a raised platform or a band of granite setts across the road should be considered.

13.7 The zone exit sign is shown in figure 13-3. Design details are shown on working drawing NP 664.1, available on request from the Department. The sign to diagram 664 (see para 12.12) is not appropriate as this is prescribed only for indicating the end of a controlled parking zone, as described in regulation 4, and cannot be used for any other purpose. It is unlikely that two zone exit signs will be required, one on each side of the road, as full waiting restriction signing (upright signs and yellow lines) will resume. However, two signs might be required if the road beyond the zone boundary has no prohibition of waiting. The end sign is replaced by a sign to diagram 663 or 663.1 where the restricted parking zone adjoins a controlled parking zone (see section 12).

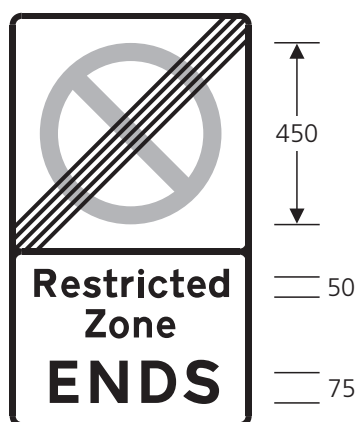

Figure 13-3 End of restricted parking zone

SIGNS WITHIN THE ZONE

13.8 The repeater signs within the zone indicating the prohibition of waiting and, where applicable, the prohibition of loading are based on diagram 637.2, as shown in section 11, with the legend "Pedestrian Zone" varied to "Restricted Zone". Design details are shown on working drawing NP 637.4, available on request from the Department. An example is shown in figure 13-4. As for diagram 637.2, the time period in the upper panel is varied to "At any time" when the prohibition of waiting applies at all times. "At any time" signs are needed as there are no double yellow lines within the zone (unlike conventional signing, described in para 6.6, where time plates for a "no waiting at any time" prohibition are not provided). The lower panel may be varied to diagram 638 to indicate "No loading at any time". Where the entry sign indicates "No loading" (see figures 13-1 and 13-2), the time periods shown in both the upper and lower panels of the repeater sign will be the same. Where the lower panel shows a shorter time period or is omitted, the zone entry sign will not display the legend "No loading" (see para 13.5). These signs should be placed strategically so that where drivers might be tempted to stop, they can see a sign. The spacing between consecutive signs, whether or not they are on the same side of the road, should be no more than 30 m. The signs may be mounted on lamp columns or separate posts. Alternatively, it might be possible to mount them on walls. They should not be mounted where they might be obscured by pedestrians or by vehicles that are legally parked (e.g. where loading is not prohibited).

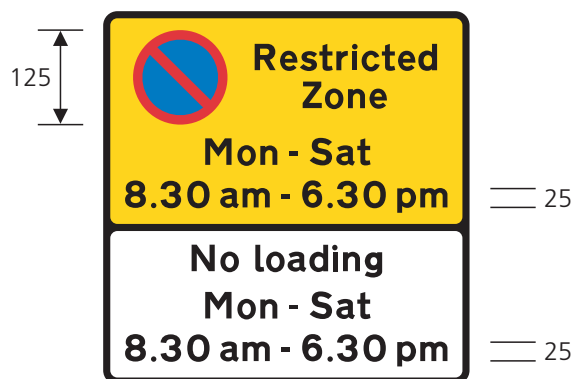

Figure 13-4 Example of a sign within a restricted parking zone, indicating the prohibition of waiting and loading

The lower panel is omitted when loading is not prohibited

13.9 Where parking places or loading bays are provided within the zone they will be indicated by upright signs as described in section 7. Where the bays are delineated by surface treatment rather than by road markings, or where only the end of each bay is marked with white lines, the parking and loading signs should be located at the end of the bay and include an arrow pointing in the appropriate direction. This is very important where two different types of bay are next to each other. Where the bay is adjacent to a section of road that is subject to the prohibition of waiting and loading indicated on the zone entry sign, the sign shown in figure 13-4, incorporating an arrow pointing in the appropriate direction, should also be erected at the end of the bay.

13.10 The upright signs indicating the use of each parking or loading bay must include the times of operation, even if these are the same as indicated on the zone entry signs. Where parking controls operate for a shorter period than the waiting restrictions and unlimited parking is permitted at other times, this

should be indicated on the signs. For example, if the general restriction is “no waiting at any time” and a limited waiting bay, as described in para 7.8, is provided from 8 am to 6 pm, the implication is that the zonal prohibition of waiting applies from 6 pm to 8 am unless the parking sign includes the legend “No limit at other times”. The legend “Free at other times” would be appropriate for a part-time pay and display parking place. Where a loading bay operates for part of the day and is used for general parking at other times, the upright sign needs to indicate this. If waiting is prohibited within a bay for part of the day, it should be signed in accordance with paras 7.30 and 7.31.

13.11 Many of the signs required within the zone are not prescribed by the Regulations (e.g. the sign shown in figure 13-4 and the indication of unlimited parking as described in para 13.10). Traffic authorities should seek advice on the design of these signs from the Department as a scheme is being developed (see para 13.4).

14 SPEED LIMITS

GENERAL

14.1 Traffic authorities have a duty under section 85 of the Road Traffic Regulation Act 1984 to erect and maintain prescribed speed limit signs on their roads in accordance with the Secretary of State's directions; i.e. the signs must be prescribed by and provided in accordance with the Traffic Signs Regulations and General Directions 2002 unless they have been specially authorised. Signs that do not strictly follow the Regulations and the Directions (see para 1.4 in respect of Northern Ireland), or have not been specially authorised are not lawfully placed and the speed limit might be unenforceable. To avoid the risk of failed prosecutions, it is of the greatest importance that speed limits be signed lawfully. It is equally important that speed limits be signed clearly and in accordance with this guidance, so that at no time will drivers be in any doubt about the prevailing limit.

14.2 Speed limits are defined in regulation 5 and are referred to in this section as follows:

- (i) National speed limit, being 70 mph on motorways and dual carriageway roads and 60 mph on single carriageway roads (see regulation 5(2))
- (ii) Maximum speed limit, being an upper limit (see regulation 5(1)). This includes restricted roads (sections 81 and 82 of the Road Traffic Regulation Act 1984), which are those roads with a speed limit of 30 mph by virtue of the presence of a system of street lighting (carriageway lighting in Scotland) where lamps are placed not more than 183 metres apart (185 metres in Scotland)
- (iii) Minimum speed limit, being a speed below which vehicles must not be driven (see regulation 5(1)).

Any maximum speed limit below 30 mph (other than a temporary limit made under section 14 of the Road Traffic Regulation Act 1984, or a 20 mph limit or a 20 mph zone) requires the consent of the Secretary of State (paragraphs 13 and 14 of Schedule 9 to the Act as amended by the Road Traffic Regulation Act (Amendment) Order 1999); such limits are unlikely to be agreed. References in this section to street lighting should be taken in Scotland to be references to carriageway lighting.

14.3 The Directions set out the requirements for the placing of signs to indicate speed limits. These are described in detail in the following paragraphs (see para 1.4 in respect of Northern Ireland). In most cases these are minimum requirements; additional signs may be provided where appropriate. This section supersedes Traffic Advisory Leaflet 1/95, which is now withdrawn.

TERMINAL SIGNS INDICATING MAXIMUM AND NATIONAL SPEED LIMITS

14.4 Terminal signs to diagram 670, provided in accordance with directions 8 and 9, are used to indicate the beginning of maximum speed limits. These signs will indicate a speed of 20 mph (except for a 20 mph zone; see paras 14.30 to 14.32), 30 mph, 40 mph or 50 mph. On dual carriageway roads only, they may indicate a speed of 60 mph. Diagram 670 is not used to indicate the national speed limit; the appropriate sign is that shown in diagram 671. All speed limits, except those for tramcars (see para 14.49) are signed in miles per hour.

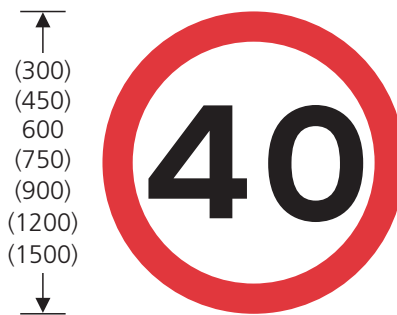

670 Maximum speed limit in miles per hour

The numerals may be varied (see para 14.4)

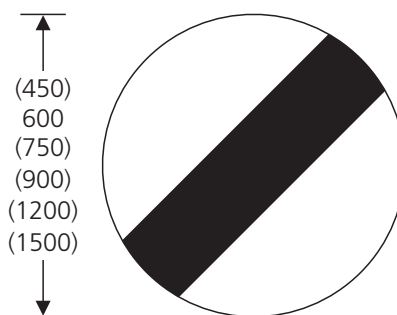

671 National speed limits apply

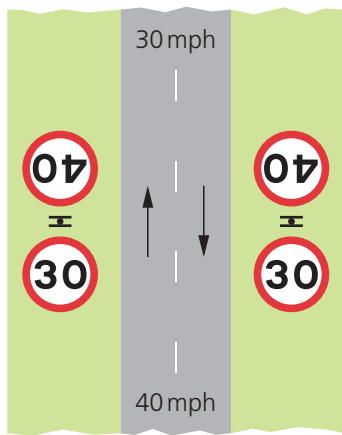

Figure 14-1 Terminal signs for single carriageway road

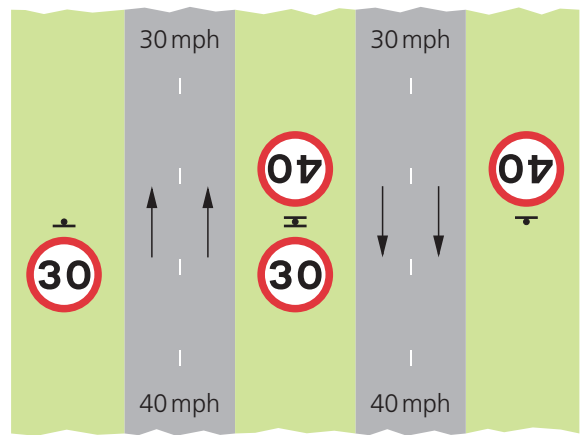
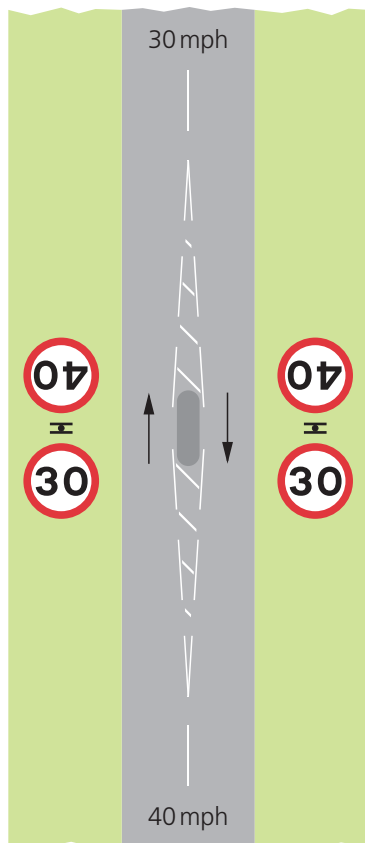
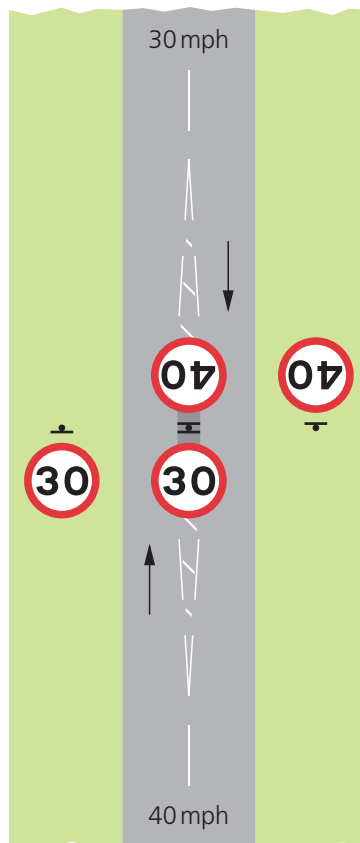

Figure 14-2 Terminal signs for dual carriageway road

On wide central reservations the two signs should be mounted separately, closer to each carriageway



Correct (in accordance with direction 8)



Not lawful (road has only one carriageway for the purposes of direction 8). This arrangement must not be used

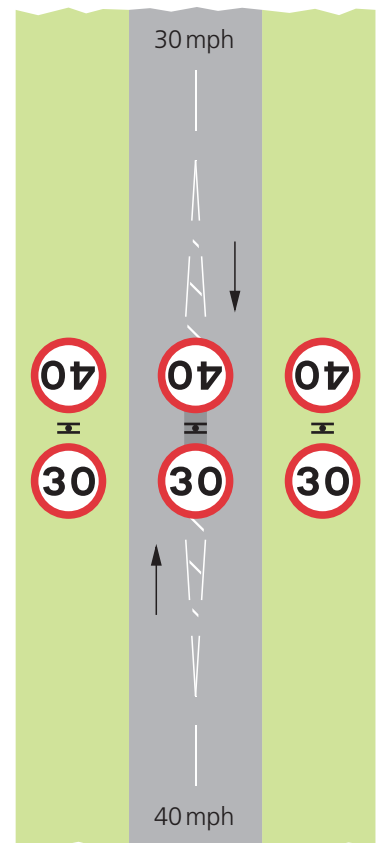

Optional (signs may be placed on island as well as on each side of road, but is visually intrusive and not generally recommended)

Figure 14-3 Terminal signs for single carriageway road with traffic island

14.5 Direction 8 requires the placing of paired terminal signs to indicate the start of a speed limit. The sign to diagram 671 is used where a speed limit ends and the national speed limit applies. Diagram 671 is therefore referred to in direction 10 (signs indicating the end of a speed limit) and not in direction 8.

14.6 Direction 8(2) introduces the expression “relevant road”, which, in the case of speed limits, means the length of road subject to the speed limit that is being signed and to which the speed limit order applies. This term is also used in direction 9 which sets out the requirements for signing speed limits at road junctions.

14.7 Direction 8(3) requires a speed limit terminal sign to be placed on each side of the relevant road, or on each side of the appropriate carriageway if the relevant road is a dual carriageway (i.e. on the near side and on the central reservation), at or as near as practicable to the point where the speed limit begins. On a road with a 30 mph speed limit by virtue of street lighting (i.e. a restricted road; see para 14.2), where the adjacent length of road is unlit and is subject to the national speed limit, the 30 mph speed limit will begin at the first lighting column. The terminal signs are placed on, or in line with, that column as appropriate. To ensure that drivers are aware of the commencement of the 30 mph limit, it is essential that the terminal signs are correctly placed and clearly visible (see para 14.19). If the 30 mph limit is to start at some other point (before or after the street lighting begins), it will be necessary to make a speed limit order and locate the terminal signs accordingly. Where a 30 mph limit commences on an unlit section of road and continues as a restricted road on the lit section, additional terminal signs must not be placed, in either direction, at the point where the street lighting begins, i.e. where the 30 mph speed limit order ends and the restricted road begins (but see para 14.22). Where a single carriageway road has a central traffic island, it is not a dual carriageway at that point (see regulation 4 for definitions of “dual carriageway road” and “central reservation”). The terminal signs should therefore be erected on both sides of the road, not on the near side and the central island. However, a third sign may be erected on the island if the road geometry makes the off side sign difficult to see. A third sign is otherwise unnecessary. Figures 14-1 to 14-3 show the requirements for siting terminal signs on both single and dual carriageway roads.

14.8 Direction 8(4) sets out conditions when a single terminal sign may be used to indicate the beginning of a restriction or prohibition (see para 1.19) but this does not apply to speed limits.

14.9 Direction 9 sets out the circumstances where the requirements specified in direction 8(3) (see para 14.7) may be relaxed. Direction 9(1)(a) removes the requirement to provide terminal signs imposed by direction 8(3) where the relevant road begins and has no junction with another road. This refers to the end of a cul-de-sac, where the speed limit on that road obviously begins but where terminal signs would serve no purpose. Direction 9(1)(b) removes the need to provide terminal signs where the relevant road begins at the junction of another road and both roads are subject to the same speed limit. The main body of direction 9 (i.e. 9(2) to 9(5) inclusive) applies to the signing of road junctions where the relevant road has a junction with the side of another road (referred to as “the other road”) and each road has a different speed limit. ***The relevant road is the side road and the other road is the major road.*** The signing requirements are set out in paras 14.10 to 14.17. They apply to junctions with ***all*** roads to which the public has access, whether private or not (see para 2.1).

14.10 Direction 9(3) is concerned with the sign that indicates the speed limit on the side road (the relevant road) to traffic entering that road from the major road (the other road). A terminal sign need be provided only on the left hand side of the carriageway of the relevant road (the left hand side of the appropriate carriageway in the case of a dual carriageway road) not more than 20m from the junction (see also para 14.13). This distance should be measured from the edge of the carriageway of the major road.

14.11 Direction 9(4) is concerned with the signs that indicate the speed limit in force on the major road (the other road) to traffic leaving the side road (the relevant road). A terminal sign must be provided on each side of the carriageway of the relevant road not more than 20m before the junction unless direction 9(5) applies (see paras 14.12 and 14.13). Where the relevant road is a dual carriageway, this means on each side of the carriageway approaching the junction (i.e. the near side and the central reservation). If the relevant road is not a dual carriageway, but has a central traffic island within 20m of the junction, the terminal signs must be erected on both sides of the road, not just on the

near side and on the central island. A third sign should be erected on the island only if the road geometry makes the off side sign difficult to see. The distance of 20m should be measured from the edge of the carriageway of the major road. Where the major road (the other road) is subject to the national speed limit, directions 10(7) and 10(8) apply (see para 14.16).

14.12 Direction 9(5) applies where the speed limit on the major road (the other road) is higher than the speed limit on the side road (the relevant road). In this case, the terminal signs referred to in para 14.11 are not required where a repeater sign has been placed on the major road on each side of, and not more than 100m from, the junction. This relaxation does not apply where the major road is

subject to the national limit (see para 14.16). Where the junction configuration or permitted turning movements are such that it is not practicable to provide repeater signs on the major road in accordance with direction 9(5), a pair of terminal signs must be provided on the exit from the side road in accordance with direction 9(4) (see para 14.11).

14.13 Figures 14-4 to 14-7 illustrate the signing requirements imposed by directions 9(2) to 9(5). It should be stressed that these are the minimum requirements that have to be met in order to comply with the Regulations and Directions and with section 85 of the Road Traffic Regulation Act 1984. There is nothing to prevent traffic authorities from providing additional terminal signs at road junctions,

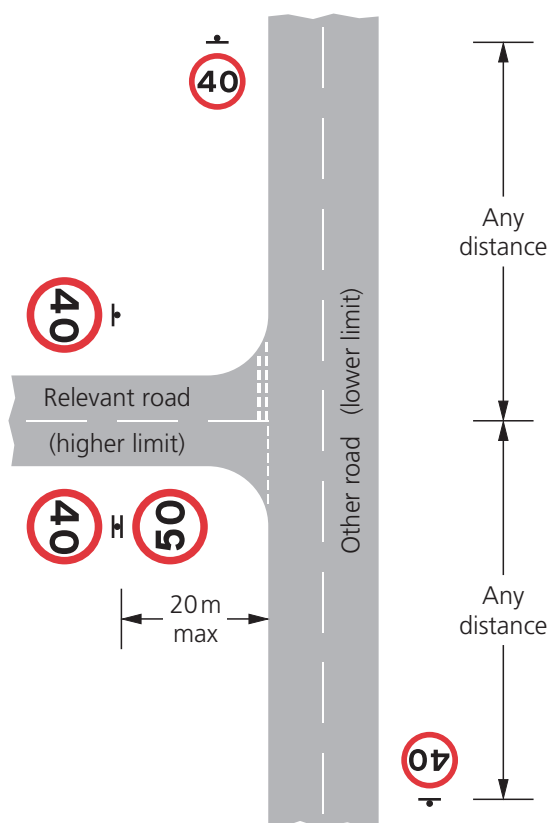

Figure 14-4 Terminal signs at a road junction where the side road (relevant road) has a higher speed limit than the major road

Direction 9(3) requires only one sign on entering the side road. Direction 9(4) requires two signs to indicate the speed limit on the major road (the other road) when leaving the side road. Direction 9(5) does not apply as the speed limit is lower on the major road

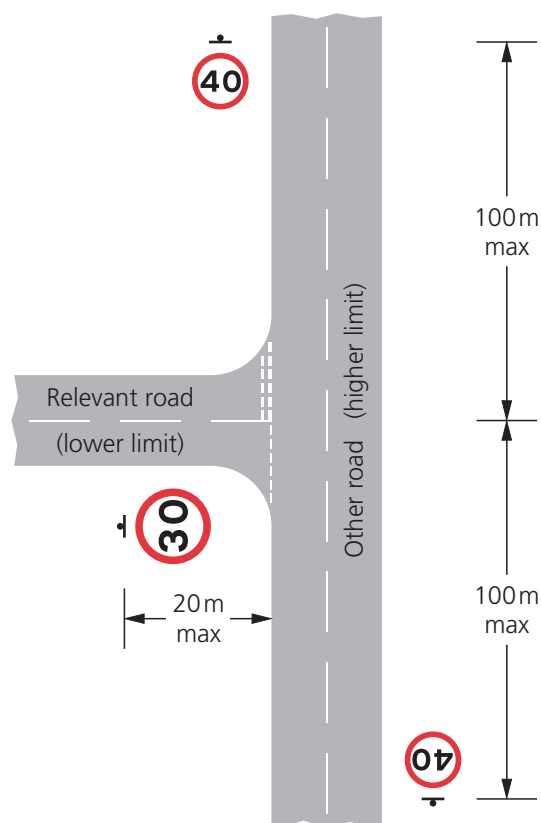

Figure 14-5 Terminal signs at a road junction where the side road (relevant road) has a lower speed limit than the major road

*Direction 9(3) requires only one sign on entering the side road. Direction 9(5) allows the two signs indicating the speed limit on the major road when leaving the side road (as shown in figure 14-4) to be omitted where the **higher** speed limit is indicated by repeater signs not more than 100m from the junction*

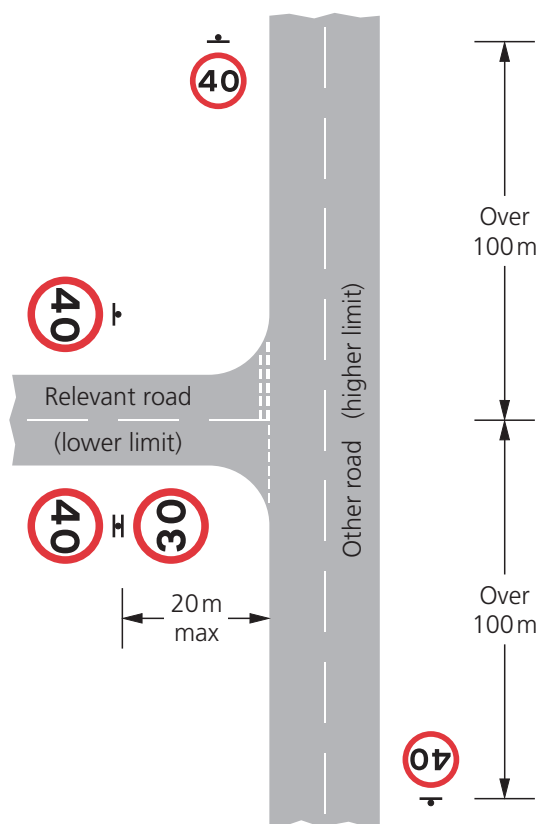

Figure 14-6 Terminal signs at a road junction where the side road (relevant road) has a lower speed limit than the major road

*Direction 9(3) requires only one sign on entering the side road. Direction 9(5) does not apply, as it does for figure 14-5, because the repeater signs indicating the **higher** speed limit are more than 100 m from the junction (note: if only one of the two repeaters shown was more than 100 m from the junction, direction 9(5) would still not apply). Direction 9(4) therefore applies and requires two terminal signs on the exit from the side road*

e.g. a sign on each side of the carriageway of the side road in both directions (see figure 14-8). For example, it might be better to inform drivers in the side road of a higher limit on the major road by providing terminal signs rather than depending solely on repeater signs on the major road. This might be a consideration where the speed limit increases from, say, 30 mph to 50 mph and drivers need to be aware of much faster traffic speeds when assessing gaps in the traffic flow in order to join the major road. It might also arise if placing repeater signs within 100 m of the junction would conflict with terminal signs for a change in the limit on the major road (see para 14.24). Where the

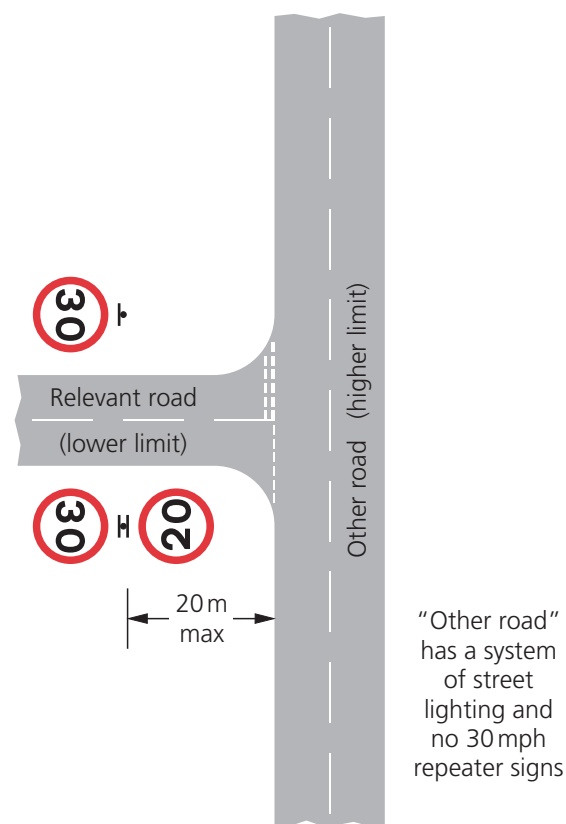

Figure 14-7 Terminal signs at a road junction where the side road (relevant road) has a lower speed limit than the major road

*Direction 9(3) requires only one sign on entering the side road. Direction 9(5) does not apply, as it does for figure 14-5, because there are no repeater signs indicating the **higher** speed limit (note: this applies where the higher limit is 30 mph and the road has street lighting – see para 14.21). Direction 9(4) therefore applies and requires two terminal signs on the exit from the side road*

side road makes an acute angle with the major road, it might be better to provide two signs on the entry to the side road, particularly where the speed limit is higher, to avoid drivers being misled into thinking that the sign applies to the major road (see figure 14-9). There may be some junction layouts where it is not practicable to provide terminal signs within 20 m of the junction. In such a situation, the speed limit orders for the side and major roads will need to provide for the speed limit on the major road to extend for a short distance along the side road; terminal signs would then be provided in accordance with direction 8(3).

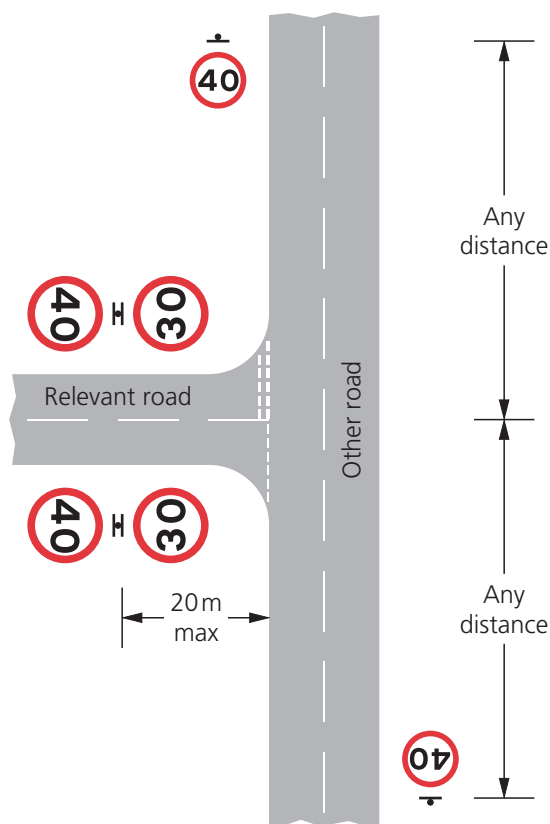

Figure 14-8 Full provision of terminal signs at a road junction where the side road (relevant road) has a lower speed limit than the major road

Although this exceeds the requirements of direction 9 as shown in figures 14-5 and 14-6, it is permitted and is likely to better inform drivers at many locations

14.14 Direction 10 sets out the requirements for signing the end of a speed limit, i.e. the point where a speed limit changes to the national limit. Direction 10(4) requires a terminal sign to diagram 671, indicating that a road ceases to be subject to a speed limit (i.e. the national speed limit applies), to be placed on each side of the relevant road or on each side of the appropriate carriageway if the relevant road is a dual carriageway (i.e. on the near side and on the central reservation) at or as near as practicable to the point where the speed limit ends. In practice, on a single carriageway road these signs would be mounted back to back with the sign to diagram 670. On a dual carriageway road, the sign on the central reservation would be mounted back to back with the

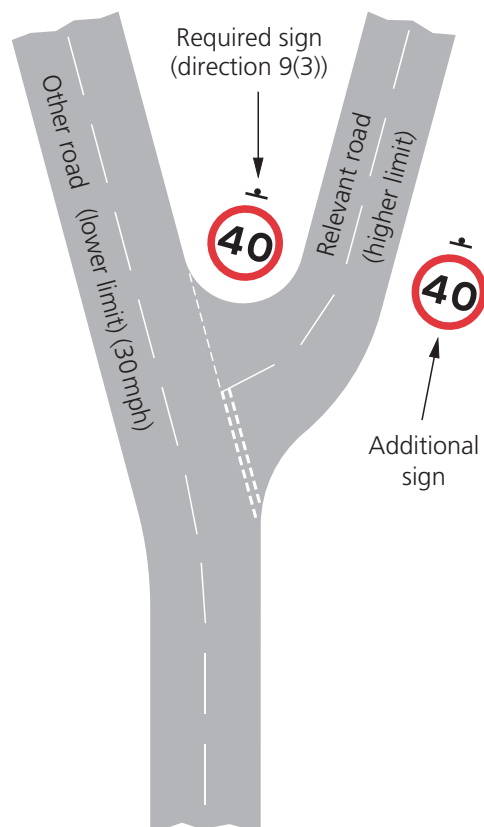

Figure 14-9 Road junction where the side road makes an acute angle with the major road (Signs for drivers entering the side road)

Although direction 9(3) requires only one sign to indicate the speed limit in the side road (the relevant road), drivers could mistakenly think that the sign applies to the major road (the other road); the additional sign overcomes this problem

sign to diagram 670, unless the reservation is very wide and the two signs need to be mounted separately, closer to each carriageway.

14.15 At a junction where the side road (the relevant road) is subject to the national limit and the major road it joins (the other road) has a different speed limit, directions 10(5) and 10(6) require one terminal sign to diagram 671 to be placed on the left hand side of the relevant road or on the left hand side of the appropriate carriageway of a dual carriageway road not more than 20 m from the major road, facing traffic turning into the side road from the major road (see figure 14-10). This is identical to the requirement for other speed limit signs as described in para 14.10.

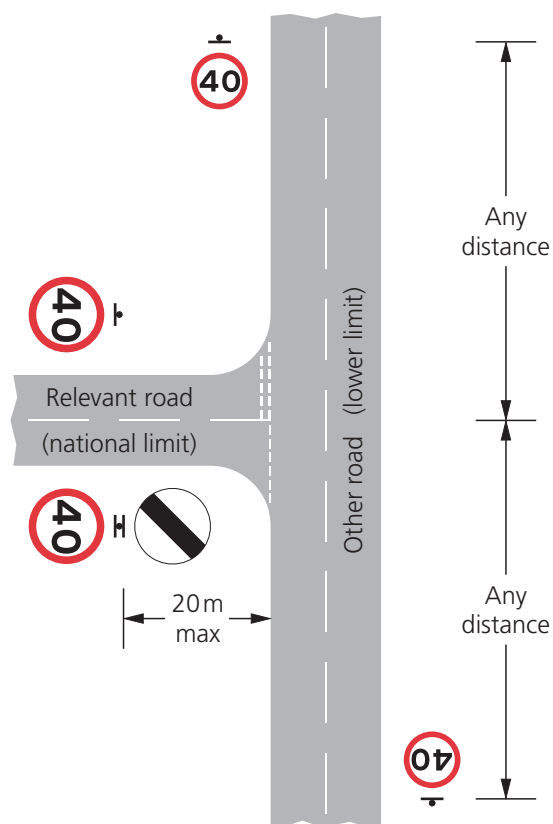

Figure 14-10 Terminal signs at a road junction where the side road (relevant road) is subject to the national speed limit

Directions 10(5) and 10(6) require only one sign to diagram 671 on entering the side road. Direction 9(4) requires two signs to indicate the speed limit on the major road (the other road) when leaving the side road. Direction 9(5) does not apply as the speed limit is lower on the major road

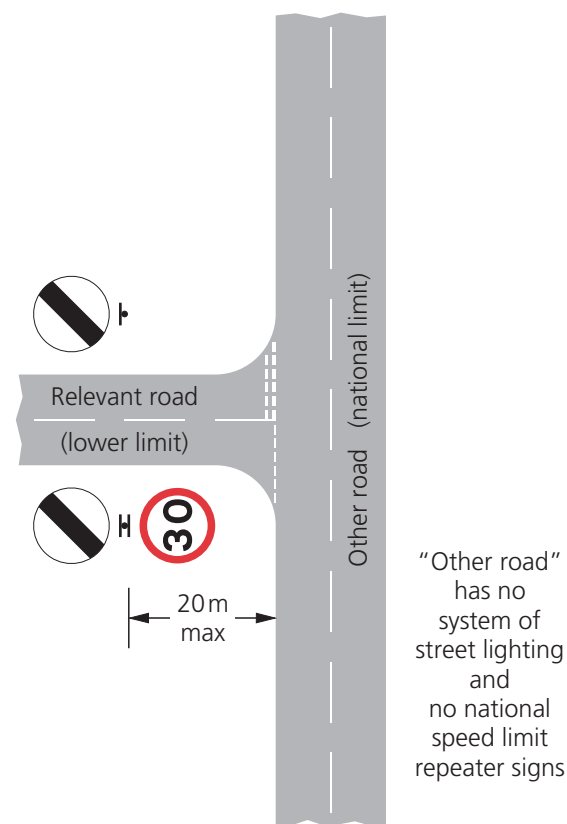

Figure 14-11 Terminal signs at a road junction where the major road (other road) has no street lighting and is subject to the national speed limit

Direction 9(3) requires only one sign on entering the side road. Directions 10(7) and 10(8) require two signs to diagram 671 to indicate the national speed limit on the major road when leaving the side road

14.16 At a junction where the major road (the other road) is subject to the national speed limit and the side road (the relevant road) has a different speed limit, directions 10(7) and 10(8) require signs to diagram 671 to be placed on each side of the relevant road or on each side of the appropriate carriageway if the relevant road is a dual carriageway (i.e. on the near side and on the central reservation) not more than 20m from the major road, facing traffic approaching the major road (see figures 14-11 and 14-12). Where the side road is not a dual carriageway, but has a central traffic island within 20m of the junction, the terminal signs must be erected on both sides of the road, not just on the near side and on the central island. A third sign

should be erected on the island only if the road geometry makes the off side sign difficult to see. The distance of 20m should be measured from the edge line of the major road. This is identical to the requirement for other speed limit signs as described in para 14.11. However, unlike the situation where the major road is subject to a speed limit (other than the national limit) higher than that on the side road (see para 14.12), the terminal signs to diagram 671 are not omitted when the major road has a system of street lighting with repeater signs to diagram 671 within 100m of the junction. If terminal signs were not used, drivers leaving the side road would not be prepared for the much higher speed of traffic on the major road.

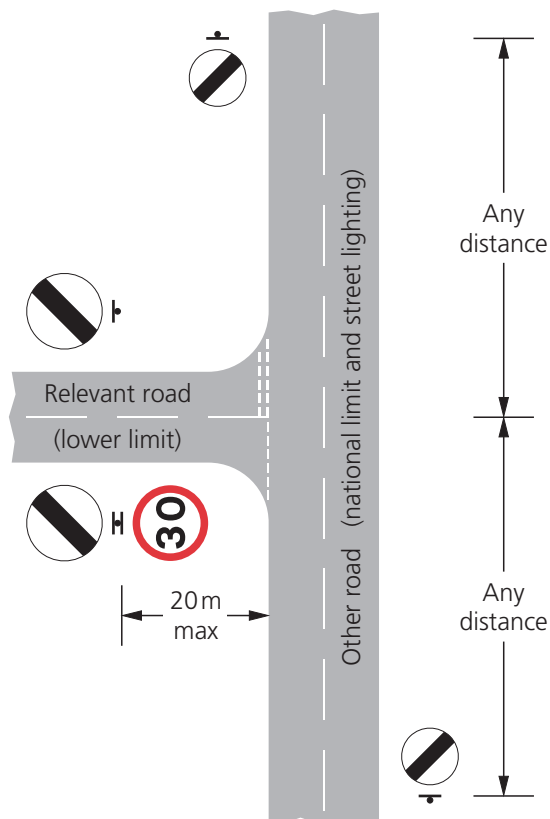

Figure 14-12 Terminal signs at a road junction where the major road (other road) has a system of street lighting and is subject to the national speed limit

Direction 9(3) requires only one sign on entering the side road. Directions 10(7) and 10(8) require two signs to diagram 671 to indicate the national speed limit on the major road when leaving the side road (whether or not there are repeater signs on the major road within 100 m of the junction)

14.17 It should be stressed that figures 14-10 to 14-12 illustrate the minimum signing requirements imposed by directions 9 and 10. These have to be met in order to comply with the Regulations and Directions and with section 85 of the Road Traffic Regulation Act 1984. There is nothing to prevent traffic authorities from providing additional terminal signs at junctions if this helps to make the signing easier to see, or its meaning clearer, e.g. where the side road makes an acute angle with the major road. It might be better to provide two signs to diagram 671 on the entry to the side road so that drivers are not misled into thinking that the national speed limit sign applies to the major road (see figure 14-13).

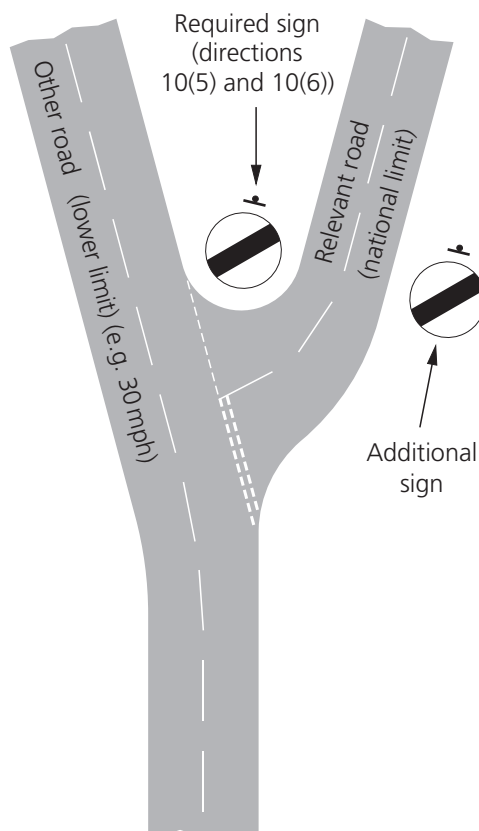

Figure 14-13 Road junction where the side road makes an acute angle with the major road (Signs for drivers entering the side road)

Although directions 10(5) and 10(6) require only one sign to indicate the speed limit in the side road (the relevant road), drivers could mistakenly think that the sign applies to the major road (the other road); the additional sign overcomes this problem

14.18 The placing of terminal signs at junctions as specified in directions 9 and 10 (see paras 14.10 to 14.17) applies generally to simple priority junctions, including crossroads. For other types of junction, such as roundabouts and those controlled by signals, drivers are likely to require more guidance on the speed limits in force; it is strongly recommended that full signing is provided as shown in figures 14-14 to 14-16. This would also aid enforcement where it might be difficult to establish which is the relevant road and which is the other road at the junction.

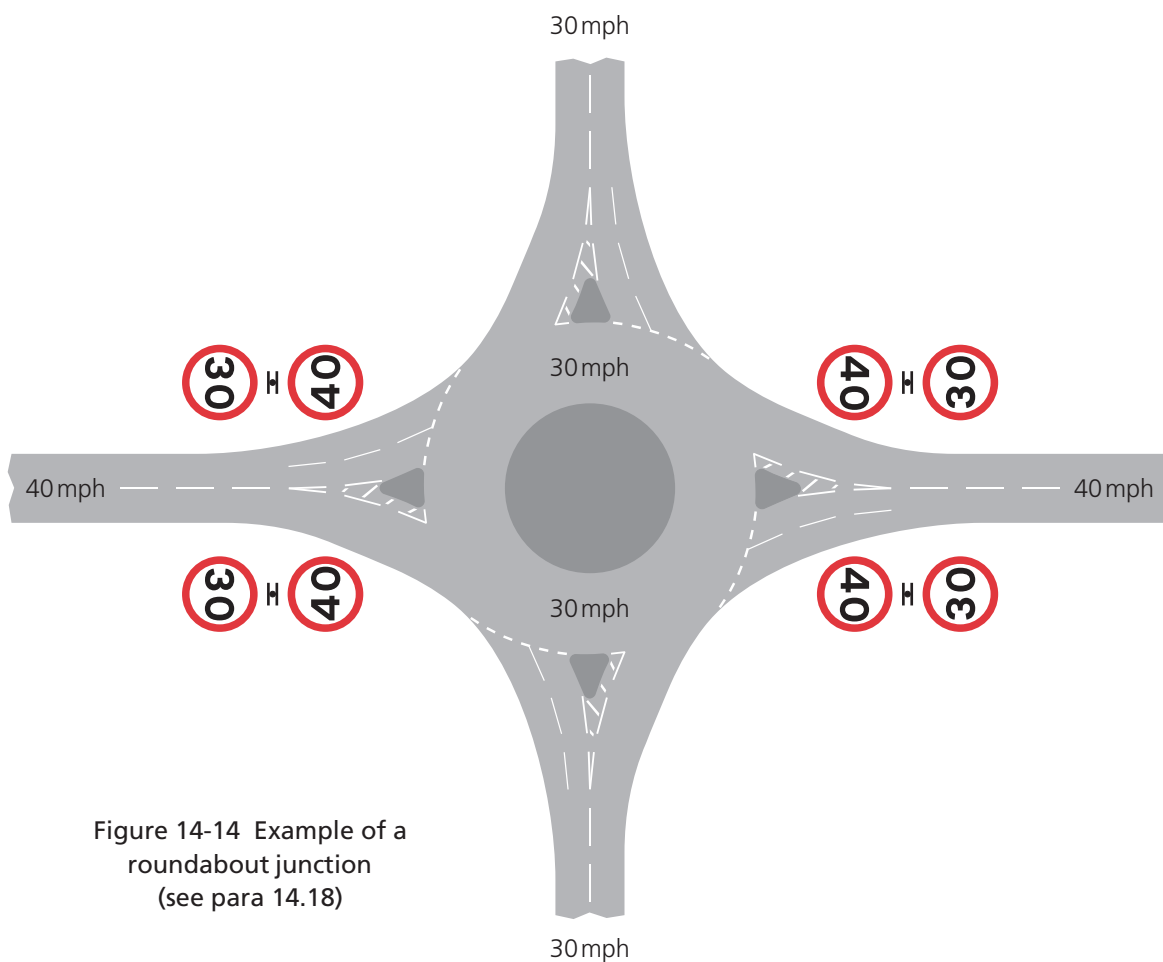

Figure 14-14 Example of a roundabout junction (see para 14.18)

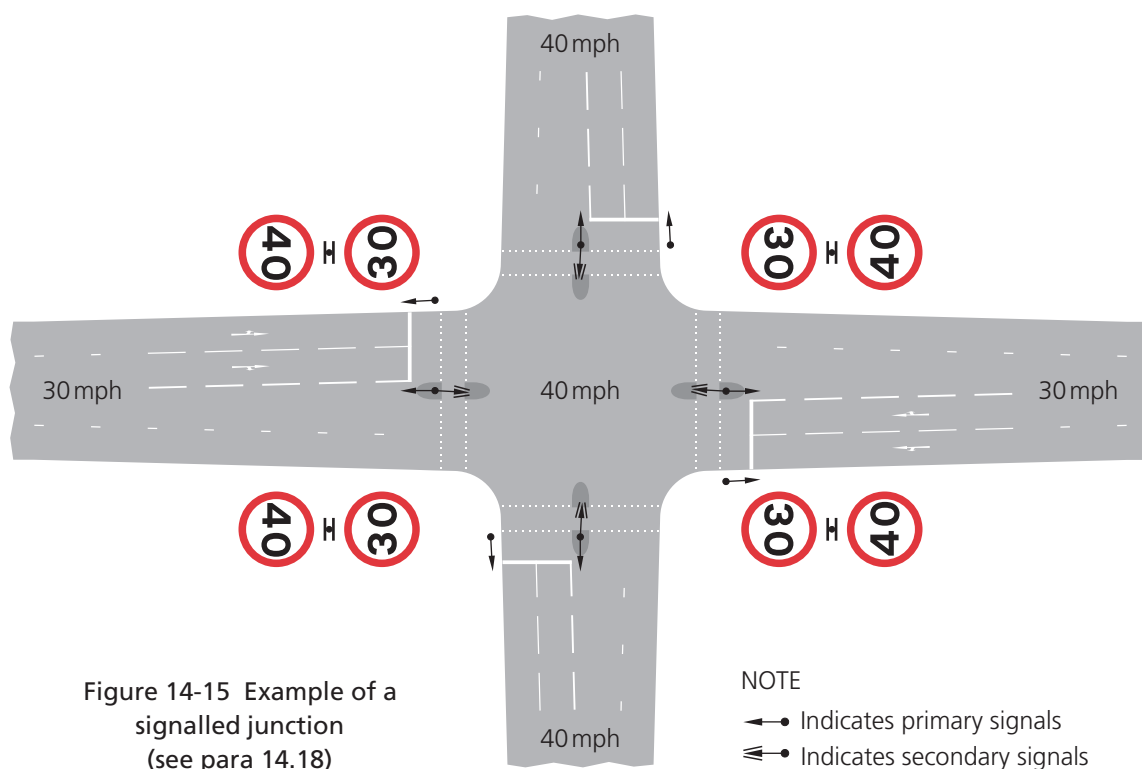

Figure 14-15 Example of a signalled junction (see para 14.18)

NOTE

- ←• Indicates primary signals
- ⋈• Indicates secondary signals

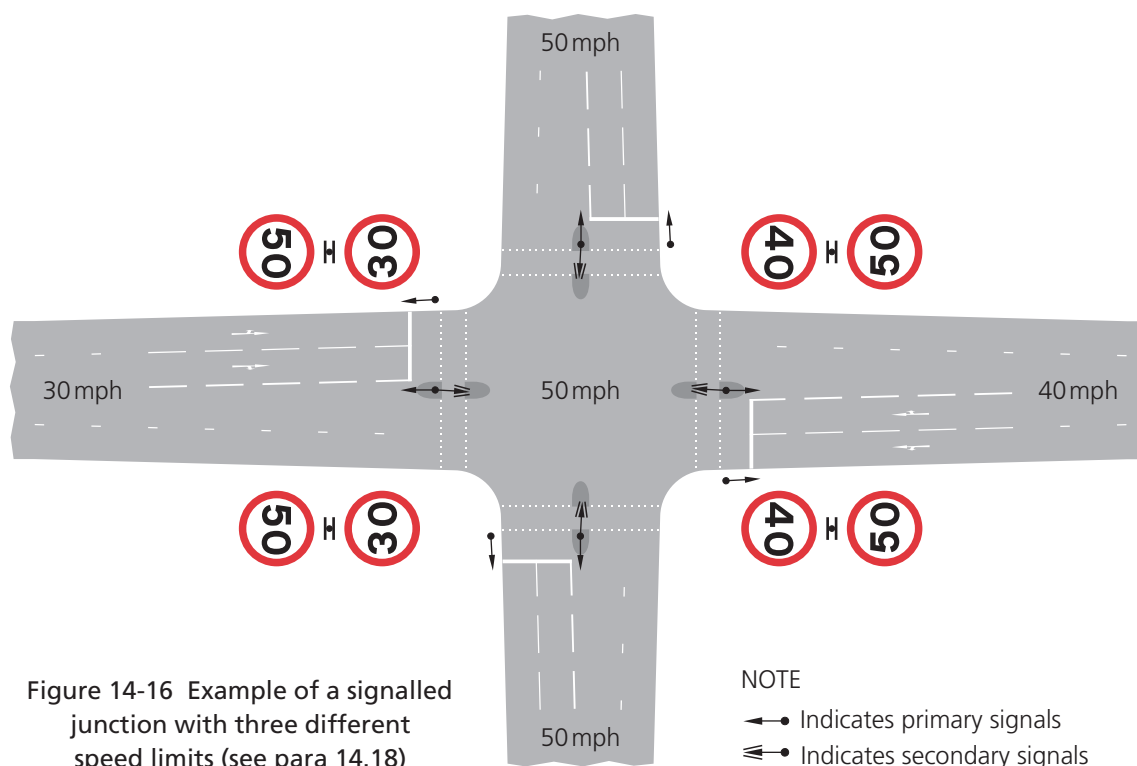

Table 14-1 Sizes of terminal signs (other than at junctions)

Type of approach road	Speed limit on approach road (mph) (higher limit)				
	30	40	50	60	70
	Size of sign (mm)				
Single carriageway or one-way road	600	600	600	750 (600)	-
Wide single carriageway (10 m or more)	-	600	750	900 (750)	-
Dual carriageway	-	750 (600)	900 (750)	900	1200 (900)
Motorway	-	-	1200	1200	1200

NOTE 1: The smaller alternative sizes shown in brackets may be used where the 85th percentile speed on the approach road is at least 10 mph less than the legal speed limit on that road or where a narrow central reservation or similar constraint makes the larger size impracticable.

NOTE 2: Where the terminal sign indicates a higher speed limit, this should generally be the 600 mm size, except that a 750 mm sign should be used on dual carriageway roads where the lower approach speed limit is 50 or 60 mph.

NOTE 3: Where signs of different diameters are to be mounted back to back (and a backing board is not used), consideration should be given to using the larger diameter for both, as this should result in a neater and less cluttered assembly.

NOTE 4: See table 14-2 (Note 3) for use of the prescribed size of 450 mm as a terminal sign. The prescribed 300 mm sign is used only for repeater signs (see table 14-4) and never as a terminal sign. The prescribed 1500 mm sign is for use only at road works (see Chapter 8, Part 1).

14.19 The size of the terminal sign to diagram 670 or 671, as shown in tables 14-1 and 14-2, depends upon the approach speed limit, not the limit being signed. Unless it is impracticable to do so (see Notes to the tables), the standard size of sign should be used on each side of the carriageway. This also produces a more balanced appearance. The signs should be sited so that they can be seen in good time to allow drivers to adjust their speed by the time they pass them. Obstructions to visibility such as vegetation, street furniture, buildings, bends, humps, other topographical features etc., need to be taken into account when determining the terminal point for a speed limit order. "Countdown" signs giving advance indication of a change in the speed limit are not prescribed and must not be used. Nor should the sign to diagram 818.2 be used to indicate a speed

limit ahead. Any development that takes place after a speed limit order has been made might require re-siting of the terminal signs to maintain adequate visibility, and amendment of the order. Table 14-3 shows the minimum clear visibility distances that should be maintained for terminal signs. These are based on speed differential rather than simply the approach speed limit and should normally be measured from the centre of the most disadvantaged driving lane. It is important that the full recommended sight line to the whole of the sign face is preserved.

14.20 Guidance on the illumination of speed limit terminal signs can be found in paras 14.54 to 14.58, and on their mounting and co-location with other signs in paras 14.60 and 14.62.

Table 14-2 Sizes of terminal signs at junctions

Type of junction and location of sign	Speed limit on approach road (mph) (higher limit)				
	30	40	50	60	70
	Size of sign (mm)				
Signal-controlled junction (signs viewed only from turning vehicles)	600	600	600	600 (750)	600 (750)
Signal-controlled junction (other signs)	600	600	750	750	900
Side road approach to a priority junction	600	600	600	600	750
Entry into side road at a priority junction	600	600	600	600 (750)	600 (750)
Approach to a roundabout	600	600	600	750 (600)	900
Exit from a roundabout	600	600	600	600 (750)	600 (750)

NOTE 1: The larger alternative sizes shown in brackets might be appropriate where there are high-speed flow conditions such as a diverge lane at a priority junction or spiral markings on a large roundabout. The smaller alternative size of 600 mm shown in brackets for the approach to a roundabout may be used where the 85th percentile speed is less than 50 mph.

NOTE 2: Where the terminal sign indicates a higher speed limit, this should generally be the 600 mm size.

NOTE 3: Where the width of the verge is insufficient to allow the provision of a 600 mm sign shown in the table or referred to in Note 2, a 450 mm sign might have to be used.

NOTE 4: Where signs of different diameters are to be mounted back to back (and a backing board is not used), consideration should be given to using the larger diameter for both, as this should result in a neater and less cluttered assembly.

NOTE 5: The prescribed size of 300 mm is used only for repeater signs (see table 14-4) and never as a terminal sign. The prescribed 1500 mm sign is for use only at road works (see Chapter 8, Part 1).

Table 14-3 Minimum clear visibility distances for terminal signs (other than entering a side road)

Approach road speed limit for private cars (mph)	Speed limit sign (mph)				
	20	30	40	50	60
	Visibility distance of sign (m)				
70	-	165	140	110	75
60	-	115	95	65	-
50	-	75	50	-	-
40	-	40	-	-	-
30	30	-	-	-	-

NOTE 1: On the side road approach to a priority junction or on any road where the speed limit increases, the visibility distance for each approach speed should be not less than the lowest value shown for that speed (e.g. 50 m for an approach speed limit of 50 mph). Where the approach speed limit is 20 mph, the minimum visibility distance is 20 m.

NOTE 2: Where the 85th percentile speed on the approach road is at least 10 mph less than the legal speed limit on that road, the clear visibility distance may be reduced to that appropriate to the actual speed (e.g. on a country lane subject to the national limit, where the 85th percentile speed is 50 mph the clear visibility distance should not be less than 75 m when approaching a 30 mph speed limit, and not less than 50 m when approaching a 40 mph or 50 mph speed limit).

NOTE 3: The minimum clear visibility distance indicated should be provided for both terminal signs.

REPEATER SIGNS INDICATING MAXIMUM AND NATIONAL SPEED LIMITS

14.21 Where a speed limit other than the national limit is in force, direction 11(2) requires that repeater signs are provided at regular intervals along the road. However, this does not apply to a 30 mph speed limit on a road with a system of carriageway lighting; in built-up areas it would be impracticable to place 30 mph repeater signs on every road. To do so in some cases but not others would result in inconsistency and driver uncertainty. This is therefore prohibited by direction 11(4). Section 82 of the Road Traffic Regulation Act 1984 defines a road that has a

system of street lighting (carriageway lighting in Scotland) as being a "restricted road" (see para 14.2). Section 81 specifies that the speed limit along such a road shall always be 30 mph unless an order has been made to impose another limit and remove the restricted road status. The presence of carriageway lighting therefore means that a road automatically has a speed limit of 30 mph with the lamps taking the place of repeater signs. It is therefore of critical importance that, when lit roads have a speed limit other than 30 mph, repeater signs are always provided at the appropriate intervals. Failure to do so undermines confidence in the signing of all speed limits, as drivers have only the repeaters to tell them that the limit is not 30 mph. Where a speed limit, other than 30 mph, applies before and after the point where the street lighting begins, a repeater sign should be located on, or in line with, the first lighting column.

14.22 Where a 30 mph speed limit is imposed on a road without street lighting, it is necessary to make an order. In this case 30 mph repeater signs must be provided (direction 11(2)). Where a road subject to a 30 mph limit has street lighting for only part of its length, it is recommended that the first repeater sign for the unlit section when leaving the lit section should be placed at a distance of not more than 100 m from the last street lamp. Where two consecutive street lamps within a system of street lighting are more than 183 m apart (185 m in Scotland) repeater signs should be provided on the section of road between the two lamps. That part of the road must also be covered by a speed limit order as it is not a "restricted road" (see para 14.21).

14.23 A road subject to the national speed limit (see para 14.2) does not require repeater signs except when it has a system of street lighting (direction 11(5)). The purpose of the signs is to remind drivers that the road is not a restricted road with a speed limit of 30 mph. At the point where street lighting commences on a road subject to the national speed limit, the first repeater sign should be placed in line with the first lamp; in most cases the sign would be mounted on the lighting column. This sign should be the appropriate size for a repeater sign (see table 14-4) and not the larger terminal sign. Repeater signs indicating the national speed limit are to diagram 671 and not diagram 670. National speed limit repeater signs are not required on motorways with street lighting (see para 14.27).

14.24 Sizes, maximum recommended spacing and minimum visibility distances for repeater signs are shown in table 14-4. Repeater signs should be staggered on alternate sides of a single carriageway road, or on alternate sides of each carriageway of a dual carriageway road, in accordance with table 14-4. Guidance on the mounting of repeater signs, and co-location with other signs, can be found in paras 14.61 and 14.62. At a junction where the major road has a higher speed limit than the side road, it will be necessary to reduce the spacing of

the repeater signs on the major road where these are used to indicate the speed limit to drivers entering from the side road, as the signs must be no more than 100 m from the junction in both directions (see para 14.12). Where this would result in a repeater sign being close to a terminal speed limit sign on the major road, it might be better to omit the repeater and use two terminal signs for traffic leaving the side road (see paras 14.12 and 14.13).

Table 14-4 Size, spacing and minimum clear visibility distances (CVD) for repeater signs

Speed limit and type of road (Notes 1 and 2)	Size of sign (mm)	Maximum distance (m) between			CVD (m)
		Consecutive signs on alternate sides of the carriageway (Note 3)	Consecutive signs on the same side of the carriageway	Terminal sign and first repeater	
20 mph zone	-	No repeaters	No repeaters	No repeaters	-
20 mph	300	200	300	200	20
30 mph with street lighting	-	No repeaters	No repeaters	No repeaters	-
30 mph without street lighting	300	250	400	200	30
40 mph	300	350	500	250	40
50 mph	450	450	700	350	50
60 mph (dual carriageway)	600	500	800	400	60
National speed limit (lit single carriageway)	450	500	800	400	60
National speed limit (lit dual carriageway)	600	600	900	450	70
National speed limit (unlit road)	-	No repeaters	No repeaters	No repeaters	-

NOTE 1: For the purposes of direction 11, street lighting or lit carriageway means “a system of carriageway lighting furnished by lamps lit by electricity placed not more than 183 metres apart in England and Wales or not more than 185 metres apart in Scotland”. Where a road does not have a system of street lighting throughout and requires repeater signs for both the lit and unlit sections, a repeater sign should be provided at the point where the street lighting commences.

NOTE 2: Sign size, spacing and clear visibility distance for motorways, including link roads, will be the same as shown for 40 mph, 50 mph and 60 mph, as appropriate. Repeater signs are not used on motorways to indicate the national speed limit, whether or not there is street lighting.

NOTE 3: Repeater signs need not be provided where the length of the speed limit is less than the distance shown in this column.

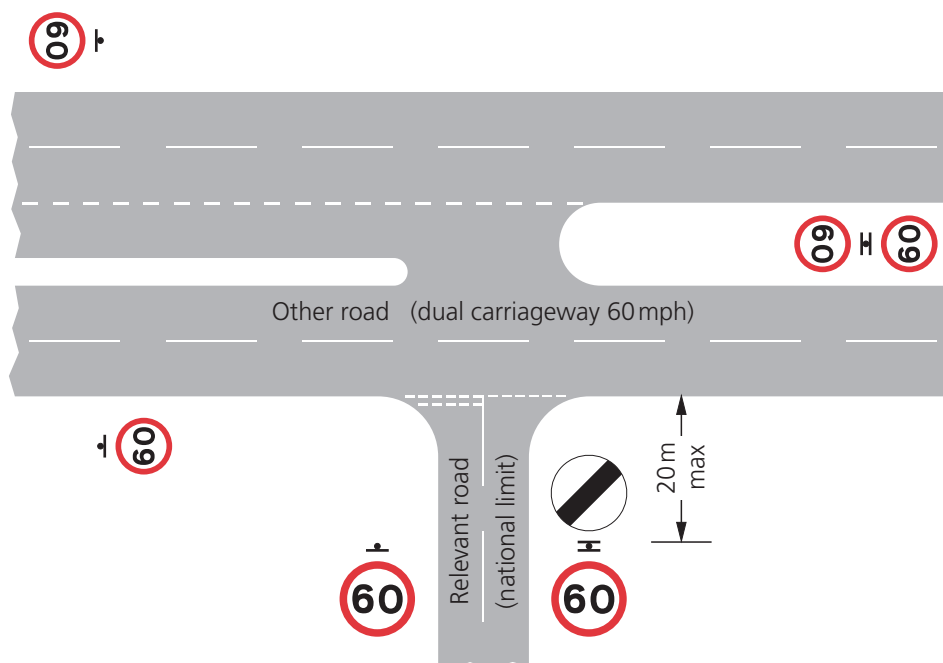

Figure 14-17 Terminal signs at a road junction where the major road (other road) is a dual carriageway with a speed limit of 60 mph and the side road is a single carriageway subject to the national speed limit of 60 mph

Although the actual speed limit is the same on both roads (i.e. 60 mph), two terminal signs to diagram 670 should be placed facing traffic leaving the side road. This is to ensure that drivers, when turning into the dual carriageway road, do not assume that the national speed limit of 70 mph applies. The repeater signs alone would not be sufficient for this purpose. Directions 10(5) and 10(6) require only one sign to diagram 671 on entering the side road

ALL-PURPOSE DUAL CARRIAGEWAY ROADS WITH A SPEED LIMIT OF 60 MPH

14.25 Where a road is part dual carriageway and part single carriageway and has a speed limit of 60 mph throughout, terminal signs must be provided at the point where the central reservation begins or ends. The speed limit on the dual carriageway will be signed as a 60 mph speed limit with terminal and repeater signs to diagram 670, varied to show "60". An order will be required to impose a 60 mph limit on the dual carriageway section. The single carriageway road will be subject to the national speed limit and should be signed as such with signs to diagram 671. Repeater signs on the single carriageway should be provided only if there is a system of street lighting (see para 14.23).

14.26 Where a two-way single carriageway road subject to the national speed limit of 60 mph has a junction with a dual carriageway road on which is imposed a speed limit of 60 mph, terminal signs to diagram 670, facing traffic approaching the dual carriageway, should be provided on each side of the road as shown in figure 14-17. In the opposite direction, only one sign, to diagram 671, is required (see directions 10(5) and 10(6)). If the side road forms a short link to another road at a grade separated junction and this other road has a speed limit other than the national limit, it might be preferable to apply this limit to the link road also, to eliminate the short length of national speed limit and hence the number of signs (see figure 14-18). This would not be appropriate, however, where the speed limit on the link road would be unrealistically low for the prevailing conditions.

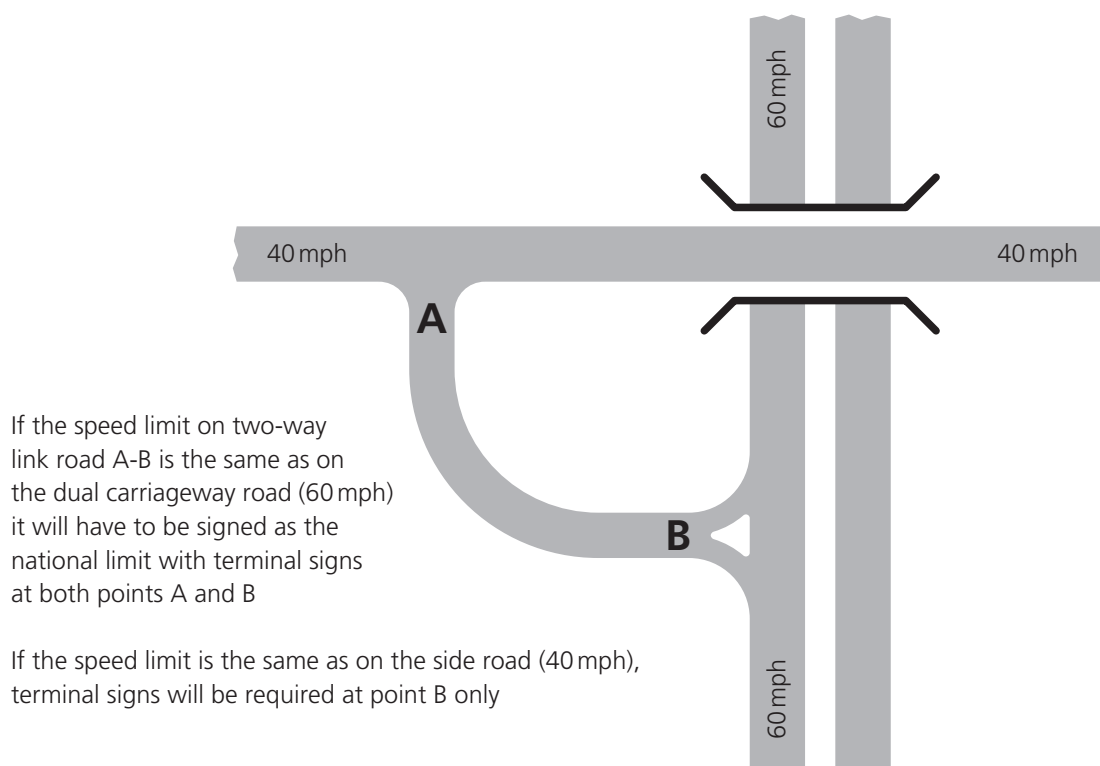

Figure 14-18 Speed limit on two-way link road between a dual carriageway road with a speed limit of 60 mph and a side road with a speed limit of 40 mph (see para 14.26)

MOTORWAYS

14.27 The placing of speed limit terminal and repeater signs is generally the same as for other roads. However, motorways do not have repeater signs indicating the national speed limit where there is a system of street lighting. Most speed limit signs on motorways will be at junctions with all-purpose roads although some lengths of motorway, particularly link roads or slip roads, will have speed limits other than the national limit. In such cases, terminal and repeater signs must be provided in accordance with tables 14-1 to 14-4. Where the start of a motorway (main carriageway or entry slip road) and the adjoining all-purpose road both have the same speed limit, other than the national limit, a repeater sign to diagram 670 should be co-located with the sign to diagram 2901 that indicates the start of the motorway. This ensures that drivers are aware that the national motorway speed limit of 70 mph does not apply at this point (see para 14.28). Where the speed limit on a motorway ends and becomes the national limit, terminal signs to diagram 671 must be erected.

14.28 Where a motorway subject to the national speed limit has a junction with an all-purpose road that has a different limit, terminal signs to diagram 670 must be provided on the exit slip road to indicate the speed limit on the all-purpose road. The requirement under section 85 of the Road Traffic Regulation Act 1984 to provide prescribed speed limit signs (see para 14.1) does not apply to motorways subject to the national speed limit. Signs to diagram 671 are not needed, therefore, on the entry slip road. The sign to diagram 2901, indicating the start of motorway regulations, also indicates that the national speed limit applies. There will be situations where the all-purpose road and the motorway are both subject to the national speed limit, and the all-purpose road or both roads have a system of street lighting. A repeater sign to diagram 671, to be viewed by drivers leaving the motorway, should then be placed on the first lighting column beyond the point where the motorway regulations end (indicated by the sign to diagram 2931). If the all-purpose road is subject to the national speed limit and is unlit, no signs are required. The signing

principles in this paragraph apply also where the main carriageway of a motorway terminates at a roundabout.

14.29 Where a motorway terminates at a grade separated junction and the main carriageway becomes an all-purpose road, the motorway regulations usually continue through the junction to the point where the entry slip road joins. If the all-purpose road has a lower speed limit than the motorway, this will be signed as described in para 14.28. However, this speed limit might sometimes commence some distance before the slip road joins and the motorway regulations end. A short section of the motorway will then be subject to a speed limit other than the national limit. This must be indicated by terminal and repeater signs. No additional signs are required where the motorway adjoins the all-purpose road; the repeater signs will continue at the appropriate spacing. In the opposite direction, terminal signs to diagram 671 must be provided on the motorway where the national limit commences. A repeater sign indicating the lower limit should be placed at the point where the motorway starts (see para 14.27). The size and spacing of repeater signs are the same on motorways and all-purpose dual carriageway roads subject to the same speed limit (see table 14-4).

20 MPH ZONES

14.30 A 20 mph speed limit is indicated by terminal and repeater signs to diagram 670 in exactly the same manner as any other speed limit (other than a 30 mph limit on a lit road where repeater signs are not permitted) as described in paras 14.4 to 14.24. However, a 20 mph zone, indicated by the sign shown in diagram 674, may be introduced without needing repeater signs (direction 11(3)), but only if it complies with direction 16. This specifies that the sign to diagram 674 may be used only if no part of a road (not being a cul-de-sac less than 80 metres long) within the zone is more than 50 metres (measured along the road) from a traffic calming feature, where a traffic calming feature is defined as:

- (a) a road hump constructed pursuant to section 90A of the Highways Act 1980 ("the 1980 Act") or section 36 of the Roads (Scotland) Act 1984 ("the 1984 Act") and in accordance with the Highways (Road Humps) Regulations 1999 or the Road Humps (Scotland) Regulations 1998;
- (b) traffic calming works constructed in accordance with section 90G of the 1980 Act or section 39A of the 1984 Act and in accordance with the Highways (Traffic Calming) Regulations 1999 or the Roads (Traffic Calming) (Scotland) Regulations 1994;
- (c) a refuge for pedestrians which was constructed pursuant to section 68 of the 1980 Act or section 27(c) of the 1984 Act after 15th June 1999 and is so constructed as to encourage a reduction in the speed of traffic using the carriageway;
- (d) a variation of the relative widths of the carriageway or of any footway pursuant to section 75 of the 1980 Act or section 1(1) or 2(1) of the 1984 Act which -
 - (i) was carried out after 15th June 1999 for the purpose of encouraging a reduction in the speed of traffic using the carriageway; and
 - (ii) had the effect of reducing the width of the carriageway; or
- (e) a horizontal bend in the carriageway through which all vehicular traffic has to change direction by no less than 70 degrees within a distance of 32 metres as measured at the inner kerb radius.

The traffic calming features ensure that the speed limit is self-enforcing and hence repeater signs are not necessary, although direction 11(3) does not prohibit their use. Speed limit zones with such features are generally more effective than 20 mph limits relying on signs alone.

14.31 Signs to diagram 674 must be provided at each entrance to the zone, even where the adjacent speed limit is 20 mph (without traffic calming features). Directions 8(3), 9(2), 9(3) and 9(4) apply to these signs in the same way that they apply to the speed limit signs shown in diagram 670 (see paras 14.5 to 14.11). In practice this means that where the zone commences in a side road at a junction, one sign only is required, provided it is located within 20 m of the junction and direction 16 is complied with. However, should a zone commence part of the way along a road, not at a junction, two signs are required, one on each side of the carriageway. This

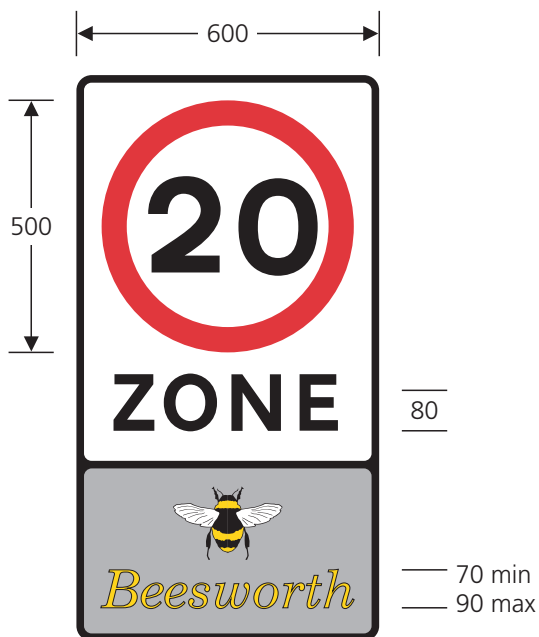

674 Entrance to a 20 mph speed limit zone

The place name may be omitted or varied to a road safety slogan (advertising material or political slogans must not be used). The symbol or pictogram may be varied or omitted. The place name may be in any style of lettering. Any contrasting colours except red may be used for the place name and the background of that part of the sign. The lower panel may be omitted

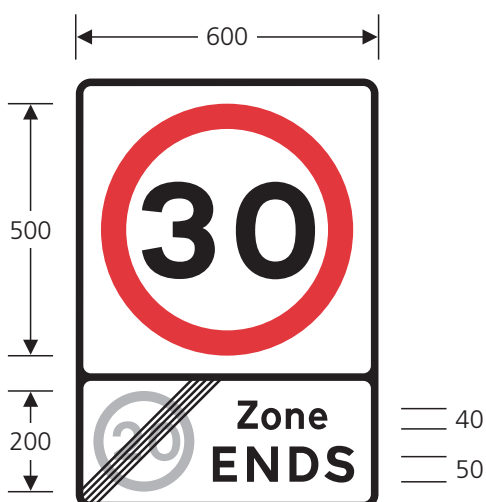

675 End of a 20 mph speed limit zone

The 30 mph speed limit may be varied to another speed limit. The upper panel may be replaced by a roundel in the form of diagram 671 against a grey background to indicate that a national speed limit applies

also applies where a road outside the zone has a junction with the side of a road that is within the zone (i.e. the major road at the junction is within the zone and the side road is outside the zone). Only one size of sign is prescribed, although the lower panel may be varied or omitted. The speed limit roundel must not be varied to any other speed limit.

14.32 The end of the zone is indicated by the sign to diagram 675, with the upper panel showing the adjacent speed limit. Where this is the national speed limit, the roundel is varied to diagram 671 on a grey background as detailed on working drawing P 675 (see para 1.9). Two signs to diagram 675 should be provided, one on each side of the carriageway, unless they are placed at a junction. Reduced signing might then be possible (see paras 14.10, 14.12 and 14.15). Where the adjacent speed limit is 20 mph (without traffic calming features), the signs to diagram 675 are replaced by 20 mph terminal signs to diagram 670.

EXTENDING THE LENGTH OF AN EXISTING 30 MPH SPEED LIMIT

14.33 Direction 11(4)(a) does not permit a 30 mph speed limit to have repeater signs where a road has carriageway lighting (see para 14.21). Any adjacent length of road which is also lit and subject to a different speed limit, including the national limit, will have repeater signs (other than a 20 mph zone). Should an order be made to extend the 30 mph limit into this adjacent length of road, the terminal signs will be moved to the new speed limit changeover point and the repeater signs removed entirely. Regular drivers might not at first realise that the speed limit has changed; they might not notice that the speed limit signs have been removed. A sign to diagram 7032 should therefore be erected to advise drivers that a new 30 mph speed limit is in force (see figure 14-19).



7032 Temporary sign indicating the start of a newly imposed 30 mph speed limit which is contiguous to an existing 30 mph speed limit

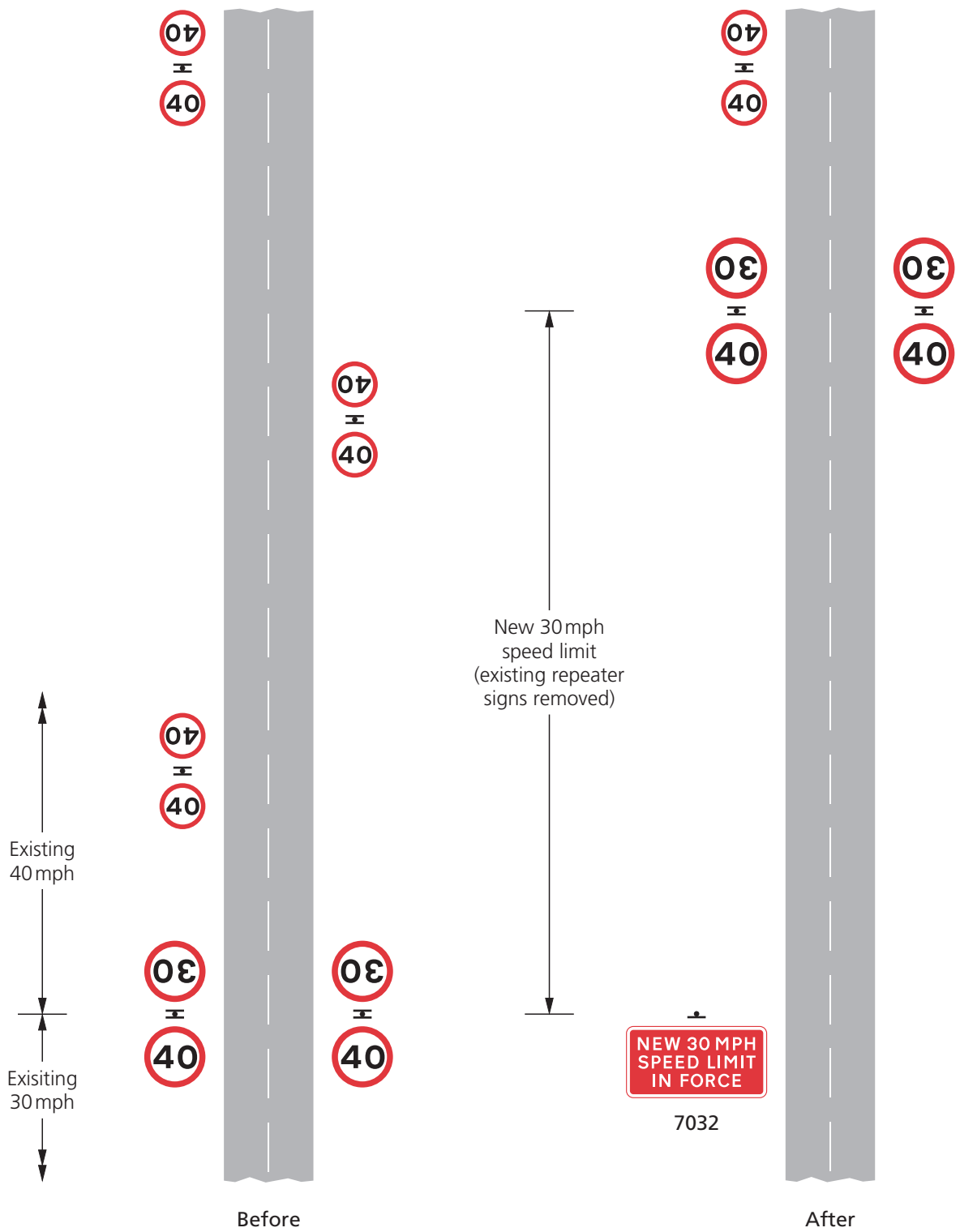

Figure 14-19 Use of the temporary sign to diagram 7032 to indicate the extension of a 30 mph speed limit on a road with a system of street lighting

14.34 Direction 37(2) sets out the conditions, all of which must be met, for the use of the sign to diagram 7032; they are:

- (i) The sign must indicate only a 30 mph speed limit (it must not be used to indicate any other speed limit)
- (ii) The road must have a system of street or carriageway lighting
- (iii) The road must have been subject to a higher speed limit (i.e. a sign to diagram 7032 is not used where the previous speed limit was 20 mph)
- (iv) The sign must be located as near as practicable to the point where the original 30 mph limit ended (i.e. where the previous terminal signs have been removed)
- (v) The sign must not be used at the point where the new 30 mph limit ends and changes to another limit (i.e. the point where new terminal signs are placed)
- (vi) The sign must be removed not later than six months after the day on which the new speed limit comes into force.

14.35 The x-height of the sign will depend on the location. In most cases the smallest size of 50 mm should be sufficient. A larger size might be required where the conspicuity of the sign needs to be increased, such as on a dual carriageway road. Only one sign, mounted on the near side, will normally be needed although a second sign on the off side should be provided where a near side sign is liable to be obscured (e.g. on a dual carriageway road).

MINIMUM SPEED LIMITS

14.36 Minimum speed limit orders are not commonly made, as it can be difficult to determine the minimum speed to be expected from vehicles in free-flow conditions. Where there is a particular problem with slow-moving vehicles, it might be preferable to prohibit certain types of traffic from the road, as described in section 5; this is likely to be easier to enforce. Where a minimum speed limit is introduced, this will be in addition to the maximum or national speed limit in force. There might be scope to co-locate the signs for both limits, especially

the repeater signs; minimum speed limit signs should be mounted below the maximum and national speed limit signs.

14.37 The start of a minimum speed limit is indicated by a terminal sign to diagram 672. A smaller size is used as a repeater sign. The end of the limit is indicated by a terminal sign to diagram 673. Directions 8(3) and 10(4) apply to the placing of terminal signs to indicate the start and end of a minimum speed limit respectively, in the same way that they apply to maximum and national speed limits. Terminal signs must be placed on each side of the road or on each side of the appropriate carriageway of a dual carriageway road (i.e. on the near side and on the central reservation) at or as near as practicable to the point where the speed limit begins. However, directions 9, 10(5) and 10(6) do not apply to minimum speed limits and there is no relaxation from the requirements of directions 8(3) and 10(4) when the terminal signs are placed in a side road at a junction. Direction 11(2) requires repeater signs to diagram 672 to be provided at regular intervals along the road.

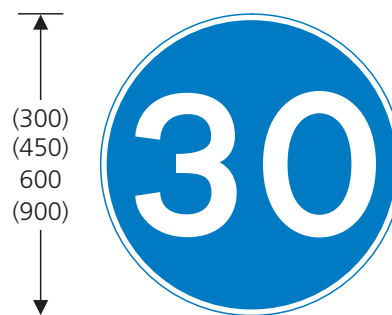

672 Minimum speed limit in miles per hour

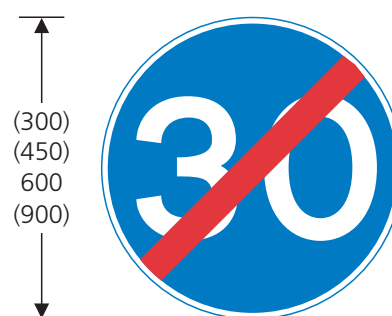

673 End of a minimum speed limit

The numerals on both signs may be varied

Table 14-5 Size of minimum speed limit signs

Maximum speed limit	Size of sign (mm)	
	Terminal	Repeater
40 mph and below	600	300
50 mph	600	300
60 mph (dual carriageway)	600	450
National limit (single carriageway)	600	450
National limit (dual carriageway)	900	450

NOTE: For terminal signs, the maximum speed limit is that on the approach.

Table 14-6 Minimum clear visibility distances in metres for minimum speed limit terminal signs

Dual carriageway road subject to the national speed limit	75
Dual carriageway road subject to a maximum speed limit of 60 mph or a single carriageway road subject to the national speed limit	65
Any other road	50

NOTE: The minimum clear visibility distance indicated should be applied to both terminal signs.

Table 14-7 Spacing of minimum speed limit repeater signs (metres)

Maximum distance between a terminal sign and first repeater	250
Maximum distance between consecutive signs on the same side of the carriageway	350
Maximum distance between consecutive signs on alternate sides of the carriageway	500

NOTE 1: The spacing of repeaters is the same for all minimum speed limits and types of road.

NOTE 2: Repeater signs need not be provided where the length of the speed limit is less than 350 m.

14.38 The sizes of minimum speed limit terminal and repeater signs are shown in table 14-5, the minimum clear visibility distance in table 14-6 and the spacing of repeater signs in table 14-7.

INFORMATORY SIGNS FOR SPEED CAMERAS

14.39 Where a speed limit is enforced by the use of cameras, traffic authorities should follow the signing, visibility and conspicuity guidance set out in DfT Circular 01/2007 "Use of speed and red-light cameras for traffic enforcement: guidance on deployment, visibility and signing". The Department also issued an "Aide Memoire on Speed Limit and Safety Camera Signing" in July 2006. Any reference in the circular and aide memoire to Traffic Advisory Leaflet 1/95 (now withdrawn) should be taken as a reference to this section.

14.40 Signs prescribed by the Regulations for indicating speed cameras are diagrams 878, 879, 880 and 880.1. The sign to diagram 878 is used to indicate the boundary of an area where camera enforcement is taking place. Direction 32(1) requires that signs to diagram 878, 879, 880 and 880.1 are

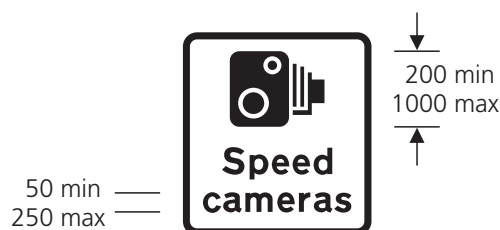

878 Area in which cameras are used to enforce speed limits (alternative types)

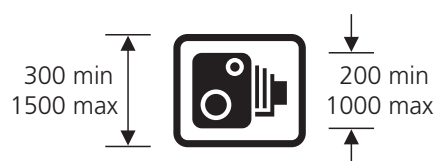

879 Reminder to drivers within an area in which cameras are used to enforce speed limits

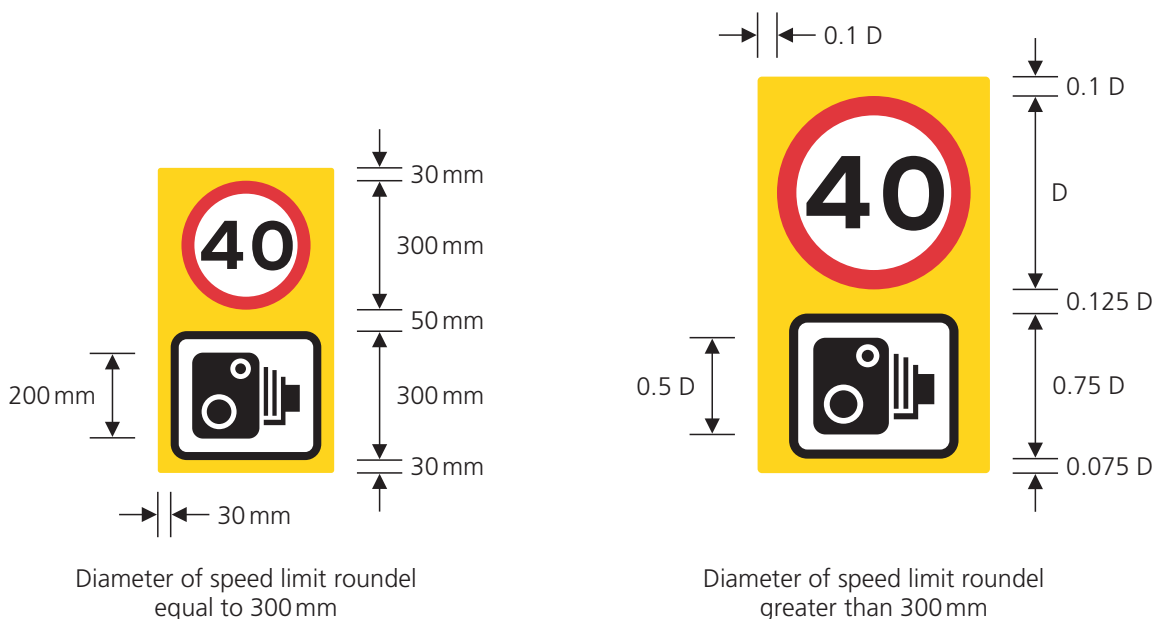

Figure 14-20 Co-located speed limit sign to diagram 670 and camera reminder sign to diagram 879

*The backing board must not have any kind of border. The colour may be varied to grey.
The roundel may be varied to diagram 671 (national speed limit)*

placed only in an area or along a route where enforcement cameras are from time to time in use. The sign to diagram 879 is a reminder that camera enforcement is taking place, and may be used more frequently than the sign to diagram 878. It is often co-located with a speed limit sign (see para 14.43).

14.41 The size of the sign to diagram 878 is related to the speed of traffic and is specified in Appendix A. The size of the sign to diagram 879 will depend on whether or not it is co-located with a speed limit sign to either diagram 670 or 671. Where it is mounted on its own, the height of the sign should not be less than the size of the speed limit repeater signs as specified in table 14-4. On lit 30 mph roads, the 300 mm size should be used. Where diagram 879 is co-located with diagram 670 or 671, the size of the sign should be as shown in figure 14-20.

14.42 Where camera enforcement utilises two cameras to measure the average speed of a vehicle over a set distance, the sign shown in figure 14-21 may be used. Although based on diagram 878, the sign is not prescribed by the Regulations. It is shown on working drawing NP878.1 (available from the Department) and requires authorisation (see para 2.1). The size of the sign will be the same as specified for diagram 878 in Appendix A.

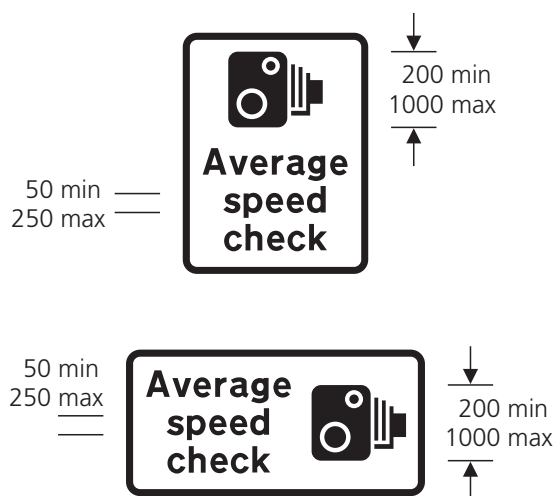
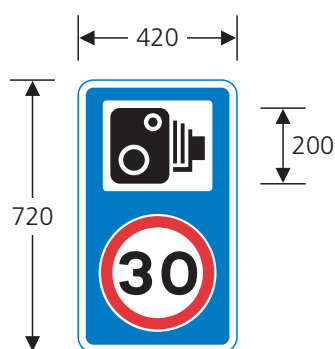
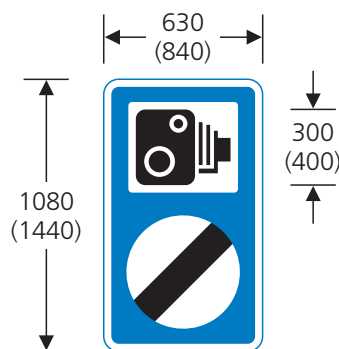

Figure 14-21 Indication that cameras are used to measure the average speed of a vehicle along a length of road (alternative types)

This sign is not prescribed by the Regulations and requires authorisation



880 Speed camera ahead and reminder of 30 mph speed limit



880.1 Speed camera ahead and reminder of national speed limit on an unlit road

14.43 On a lit road with a 30 mph speed limit, 30 mph repeater signs are not permitted (see para 14.21). However, the sign to diagram 880 may be used to advise drivers that a 30 mph speed limit is being enforced by cameras on roads that do not have repeater signs. This sign must not be used as a substitute for repeater or terminal signs, or to indicate any other limit. Direction 32(4) (introduced by the Traffic Signs (Amendment) Regulations and General Directions 2008) permits up to two signs to diagram 880 to be placed on any approach to an enforcement camera. For other speed limits, a repeater sign to diagram 670 may be co-located with the camera sign to diagram 879 as shown in figure 14-20, especially on the approach to an enforcement camera.

14.44 Where a camera is used to enforce the national speed limit on an unlit road, the sign to diagram 880.1 (introduced by the Traffic Signs (Amendment) Regulations and General Directions 2008) may be used. Direction 32(4) permits up to two signs to be placed on any approach to an enforcement camera. The sign to diagram 880.1 must not be used where there is a system of carriageway lighting (direction 32(3)): repeater signs to diagram 671 should be used, co-located with diagram 879 as appropriate (see figure 14-20).

14.45 Only one size of sign is prescribed for diagram 880, as it is only ever used on a road with a 30 mph speed limit. The sign to diagram 880.1 has two sizes; the smaller size is for single carriageway roads and the larger size for dual carriageway roads.

14.46 Speed enforcement should be highly visible, with drivers made fully aware of the presence of cameras and of the prevailing speed limit. The camera and speed limit signs should always be

clearly visible to drivers, and not obscured by other street furniture or vegetation. The minimum clear visibility distance for the signs, including diagrams 879 and 880, should be at least that shown in table 14-4. Speed limit repeaters and camera signs should be co-located where permitted and practicable (see para 14.43 and figure 14-20). For fixed cameras, the speed limit and camera signs should be visible to the driver in the same view as the camera. This may require additional speed limit repeater signs where the spacings shown in table 14-4 do not coincide with camera locations (see directions 11(6) and 11(7), as introduced by the Traffic Signs (Amendment) Regulations and General Directions 2008).

TEMPORARY SPEED LIMITS

14.47 Where temporary speed limits are provided in connection with road works, signing should be in accordance with Chapter 8. Any reference in Chapter 8 to Traffic Advisory Leaflet 1/95 (now withdrawn) shall be taken as a reference to this chapter. The sign shown in diagram 7290 (mandatory speed limit ahead) must not be used to indicate a permanent speed limit (direction 36).

MAXIMUM SPEED ADVISED

14.48 Signs indicating the maximum speed advised must not be used to indicate a mandatory speed limit. Use of the supplementary plate to diagram 513.2 is detailed in Chapter 4 (para 3.10) and in Chapter 8 (in combination with the "loose chippings" warning sign to diagram 7009). See Chapter 8 also for the maximum speed advised signs shown in diagrams 7275 and 7294.

SPEED LIMITS FOR TRAMCARS

14.49 The sign shown in diagram 976 indicates the speed limit for tramcars in kilometres per hour. The sign, which is diamond in shape to distinguish it from signs for motor vehicles, may be used both on and off the public highway. Where trams run along the highway with other traffic, the sign would normally be used to indicate a lower speed limit for tramcars. Signs to diagram 976 might not be necessary where all traffic is subject to the same speed limit. The colour of the sign may be varied in accordance with the requirements of Her Majesty's Railway Inspectorate (HMRI). Further guidance on the use of the sign should be sought from HMRI.

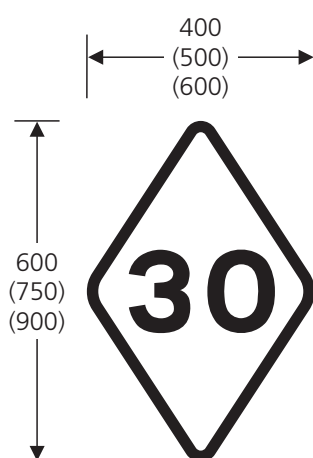

976 Maximum speed limit for tramcars in kilometres per hour

The numerals may be varied. The background, border and numerals may be in any colour in accordance with the requirements of Her Majesty's Railway Inspectorate

BACKING BOARDS

14.50 To improve conspicuity against a complex or dark background, a speed limit sign may be mounted on a grey or yellow backing board (direction 42, as amended by the Traffic Signs (Amendment) General Directions 2004), although yellow backing boards will not normally be necessary when signs indicate an increase in the speed limit. A backing board can also make for a neater assembly, e.g. when the sign is mounted with the speed camera sign to diagram 879 (see figure 14-20). Other than when diagram 670 is mounted with a boundary sign to diagram 2402.1



Figure 14-22 Example of a speed limit sign co-located with a boundary sign

(see para 14.51), any yellow backing board must be rectangular in shape (direction 42(6)). A sign to diagram 670 mounted on a yellow circular backing board is unlawful. ***A backing board must not itself be provided with a border of any kind, and no legend may be applied to it.*** Where it seems that a sign is not being noticed by drivers, it should be checked to ensure that it is well sited, not obscured by vegetation or other obstructions and is of the appropriate size and in good condition. Only then should the use of a yellow backing board be considered.

14.51 Where a speed limit terminal sign to diagram 670 is mounted with a town or village boundary sign to diagram 2402.1 (not diagram 2403.1) a yellow backing board may be shaped to suit the assembly (direction 42(7)). Figure 14-22 shows a typical example. This arrangement is often used at village gateways. As drivers need to be made fully aware of the speed limit, the boundary sign has to be of a simple design to avoid being a distraction. A speed limit sign must never be incorporated within a boundary sign. If a speed limit terminal sign, to either diagram 670 or 671, is mounted back to back with the boundary sign, any irregularly shaped backing board facing drivers leaving the town or village must be coloured grey.

14.52 A yellow backing board may be reflectorised to increase its conspicuity at night. This should not usually be necessary on unlit roads, although it might sometimes be helpful on lit roads, particularly where the sign itself is unlit. It may also be fluorescent; this greatly increases conspicuity in dull weather and at dusk. Fluorescence can also be particularly effective in drawing attention to signs mounted in deep shadow, e.g. below overhanging trees. However, fluorescence is visually intrusive and should be used with

discretion. The modern true yellow materials are less garish than the older yellow-green type and are much to be preferred.

14.53 There are potential disadvantages to the use of backing boards. The larger overall size of the assembly can sometimes obstruct sight lines. A backing board can deprive circular signs of a primary recognition aid: their distinctive silhouette. Yellow backing boards can be especially environmentally intrusive, and their over-use could eventually devalue their attention-attracting benefits. A less garish way of increasing a sign's conspicuity is simply to provide a standard sign of larger size. Detailed guidance on the correct design and use of backing boards can be found in Chapter 7 (paras 14.19 to 14.24).

ILLUMINATION OF SIGNS

14.54 Traffic signs must be illuminated in accordance with regulation 18. Specific requirements for speed limit signs are set out in Schedule 17, items 10 and 11. Item 10 requires terminal signs to diagrams 670, 671, 672 and 673 sited on trunk and principal roads (other "A" roads) to be illuminated by internal or external lighting throughout the hours of darkness when they are located within 50m of a street lamp (which does not have to form part of a system of street lighting). It is insufficient to place a sign on a lighting column; a separate means of illuminating the sign face directly must be provided. However, during any time overnight that the street lamp is switched off, the sign need only be reflectorised (i.e. the sign lighting may be turned off at the same time as the street lamp). Even where the street lamp is illuminated throughout the hours of darkness, it is recommended that the sign is reflectorised in addition to being directly lit, as a precaution against a power failure.

14.55 Other terminal signs to diagrams 670, 671, 672 and 673, i.e. those on unlit roads and those on lit roads that are not trunk or principal roads, must be either directly lit or reflectorised (Schedule 17, item 11). Again, it is recommended that where a sign is directly lit it is also reflectorised. Where a road has a system of street lighting, but is not a trunk or principal road, it is recommended that speed limit terminal signs are directly lit. Although this is not a specific requirement of the Regulations, it would minimise the risk of drivers failing to see them. Repeater sign illumination is also specified in

Schedule 17, item 11; signs may be either directly lit or reflectorised. It is unusual for such signs to be directly lit, although this is permitted.

14.56 20mph zone signs to diagrams 674 and 675 may be either directly lit or reflectorised. It is recommended that where the signs are directly lit, they are also reflectorised.

14.57 Terminal speed limit signs erected in pairs must each be illuminated by the same means (i.e. internal illumination, external illumination or reflectorisation). This applies to terminal signs on each side of the road and to those erected at the same junction for the same purpose.

14.58 Where a sign is reflectorised, reflecting material must be applied to the whole sign face except those parts which are coloured black (regulation 19). The optional reflectorisation of yellow backing boards is dealt with in para 14.52.

SIGN DESIGN

14.59 Speed limit signs must conform in appearance to the diagrams prescribed by the Regulations. The numerals in diagram 670 must be in Transport heavy alphabet (Schedule 13 Part II) and be of the correct size, as specified on the working drawing P670 (see para 1.9), and be positioned within the roundel as shown on that drawing.

SIGN MOUNTING

14.60 Research has shown that the greater the number of signs that drivers are presented with simultaneously, the greater the difficulty they are likely to have in assimilating all the information. The problem of dealing with information overload increases with age, so that older drivers suffer disproportionately. Terminal speed limit signs should not therefore normally be co-located with other signs, except for simple boundary signs to diagram 2402.1 (see figure 14-22). At junctions where signs are needed to indicate the start or end of zonal restrictions or a requirement to stop or give way, these may be co-located with terminal speed limit signs if separate mounting would cause one sign to obstruct the driver's view of another. In such cases signs should be placed in the following order from top to bottom:

- (i) STOP or GIVE WAY sign
- (ii) terminal speed limit sign
- (iii) other circular sign
- (iv) rectangular zonal sign.

Not more than one other sign should normally be erected on the same post as a terminal speed limit sign. Where a clearway sign to diagram 642 accompanied by either a distance plate or an "End" plate is mounted below a speed limit sign, the plate should be butted up against the lower edge of the clearway sign. There should be a space equal to twice the width of the red border between the roundels to ensure that there is no ambiguity.

14.61 The most cost-effective arrangement for placing speed limit repeater signs in accordance with table 14-4 is to mount the signs back to back on alternate sides of the carriageway as illustrated in the left hand part of figure 14-19. Repeater signs may be co-located with other signs such as warning signs (see para 1.26), provided the spacing requirements specified in table 14-4 are met. The repeater sign will be mounted below the warning sign. They should not normally be co-located with directional signs, as drivers searching for a destination are likely to overlook the repeater sign.

14.62 Speed limit signs should always be mounted at heights that ensure drivers can easily see them, and where they will be free from obscuration by vegetation or other street furniture. The normal mounting height for a traffic sign, measured to its lower edge, is between 900 mm and 1500 mm above the carriageway alongside (see para 1.49 in Chapter 1). It is recommended that speed limit signs should not be mounted at heights less than 1500 mm, particularly where vehicle spray is likely to soil the sign. Where speed limit signs are erected above footways, a minimum headroom of 2300 mm

is recommended, with 2100 mm as an absolute minimum. A clearance of 2300 mm should be maintained over a cycle track or shared cycleway/footway. Except where necessary to improve visibility of the sign, e.g. over the brow of a hill, or to accommodate a second sign on the same post (see para 14.60), signs should not be mounted at heights greater than this. See also paras 1.29 and 1.30.

ROAD MARKINGS

14.63 The road marking roundels shown in diagram 1065 must not be used on their own, and there is no statutory requirement to use them at all. They may be used only in conjunction with the following signs:

- (i) a speed limit sign to diagram 670 (when placed to indicate the point at which a speed limit begins, or as a repeater sign in accordance with direction 11(2)),
- (ii) a 20 mph zone sign to diagram 674 (but not the sign to diagram 675), or
- (iii) a reminder sign to diagram 880.

Further details of the road marking roundel can be found in Chapter 5 (paras 21.4 to 21.6).

14.64 The Regulations prescribe different module lengths for hazard warning lines (diagrams 1004 and 1004.1), lane lines (diagrams 1005 and 1005.1) and centre lines (diagrams 1008 and 1008.1) depending upon the speed limit. The shorter modules (diagrams 1004, 1005 and 1008) must be used where the speed limit is 40 mph or less. The longer modules (diagrams 1004.1, 1005.1 and 1008.1) must be used where the speed limit is greater than 40 mph. Whenever an order is made to change the speed limit (e.g. from the national limit to 40 mph), care should be taken to ensure that the longitudinal road markings are correct.

15 BUS LANES AND GATES

GENERAL

15.1 This section describes only bus lanes and gates that use prescribed signs, i.e. facilities for buses, cyclists and taxis. Where other vehicles such as motor cycles or heavy goods vehicles are to be admitted, or where off side with-flow lanes are to be introduced, the signs will require authorisation (see para 2.1) and guidance should be sought from the Department. Working drawings for some non-prescribed signs, including those for bus lanes that may be used by motor cycles, and those for high-occupancy vehicle lanes, are available on request from the Department.

15.2 Bus lanes may be either with-flow or contra-flow. With-flow bus lanes on the left hand side of the carriageway are always available to both buses and pedal cycles; it is not considered safe to force cyclists to use the general traffic lane where they would be confined between two streams of motor traffic. There might, however, be situations where a with-flow lane leads directly to a bus-only facility that is not available to pedal cycles (e.g. a bus-only gate or the entrance to a bus station). In these circumstances, where the bus lane excludes cyclists, traffic signs will need the Department's authorisation. A with-flow bus lane may be used by taxis (hackney carriages) where permitted by the order. A contra-flow bus lane is generally used by buses only, but pedal cycles may also use the lane where permitted by the order.

15.3 Signs and markings for bus lanes prescribed by the Regulations are for near side lanes only. Where centre or off side with-flow lanes are required, advice should be sought from the Department before submitting an application for authorisation. Contra-flow lanes should always be on the near side (see para 15.18).

15.4 Bus-only streets and bus gates are lengths of road or parts of a road where access is restricted to buses, although sometimes other vehicles such as pedal cycles, taxis and trams are also admitted.

WAITING AND LOADING RESTRICTIONS

15.5 A bus lane order should always prohibit waiting during the operational period. Signs and markings, provided in accordance with section 6, are required only where an order is made to prohibit waiting during any period when the bus lane is not in force. It is not necessary to include the operational period of

the bus lane on the waiting restriction signs, unless the two periods overlap. For example, where a bus lane operates from 7 am to 9 am and the prohibition of waiting is 6 am to 9 am, the waiting restriction signs will indicate a time period of 6 am to 9 am, not 6 am to 7 am. Where waiting is prohibited at all times and the bus lane operates for a shorter period, the road marking will be the double yellow line to diagram 1018.1. Upright "no waiting" signs are not used in this case (see para 6.6).

15.6 Loading will normally be banned also, although there may occasionally be special reasons why it needs to be allowed, such as off-peak loading in a 24-hour bus lane. Any prohibition of loading, whether during or outside the hours when the lane is in force, should always be indicated with signs and markings in accordance with section 6, but without the need also to indicate a prohibition of waiting unless waiting is prohibited outside the operational period of the lane.

15.7 A bus lane may include bus stop clearways; these should be signed in accordance with section 9.

WITH-FLOW BUS LANES

15.8 Figure 15-1 shows a typical example of the signing requirements for a road that has a with-flow bus lane. Guidance on the use of road markings is given in section 17 of Chapter 5. Figure 15-4 shows the signs that may be provided to indicate the lane to traffic approaching from a side road.

15.9 Advance indication of a with-flow bus lane is provided by the sign to diagram 958. Where the speed limit is 20 mph or 30 mph, the sign should be sited 30 m in advance of the lead-in taper formed by the road marking to diagram 1010, with a minimum clear visibility distance of 45 m. Where the speed limit is 40 mph, the sign should be sited 45 m in advance of the taper with a minimum clear visibility distance of 60 m. For higher speed limits, advice should be sought from the Department (see para 15.14).

15.10 The sign to diagram 959 is a regulatory sign and should be placed at the start of the lane, i.e. where the continuous line to diagram 1049 begins. It should be repeated just beyond each side road, other than one-way roads leading away from the major road on the opposite side to the bus lane. Additional repeater signs should be used where the distance between them would otherwise exceed 300 m.

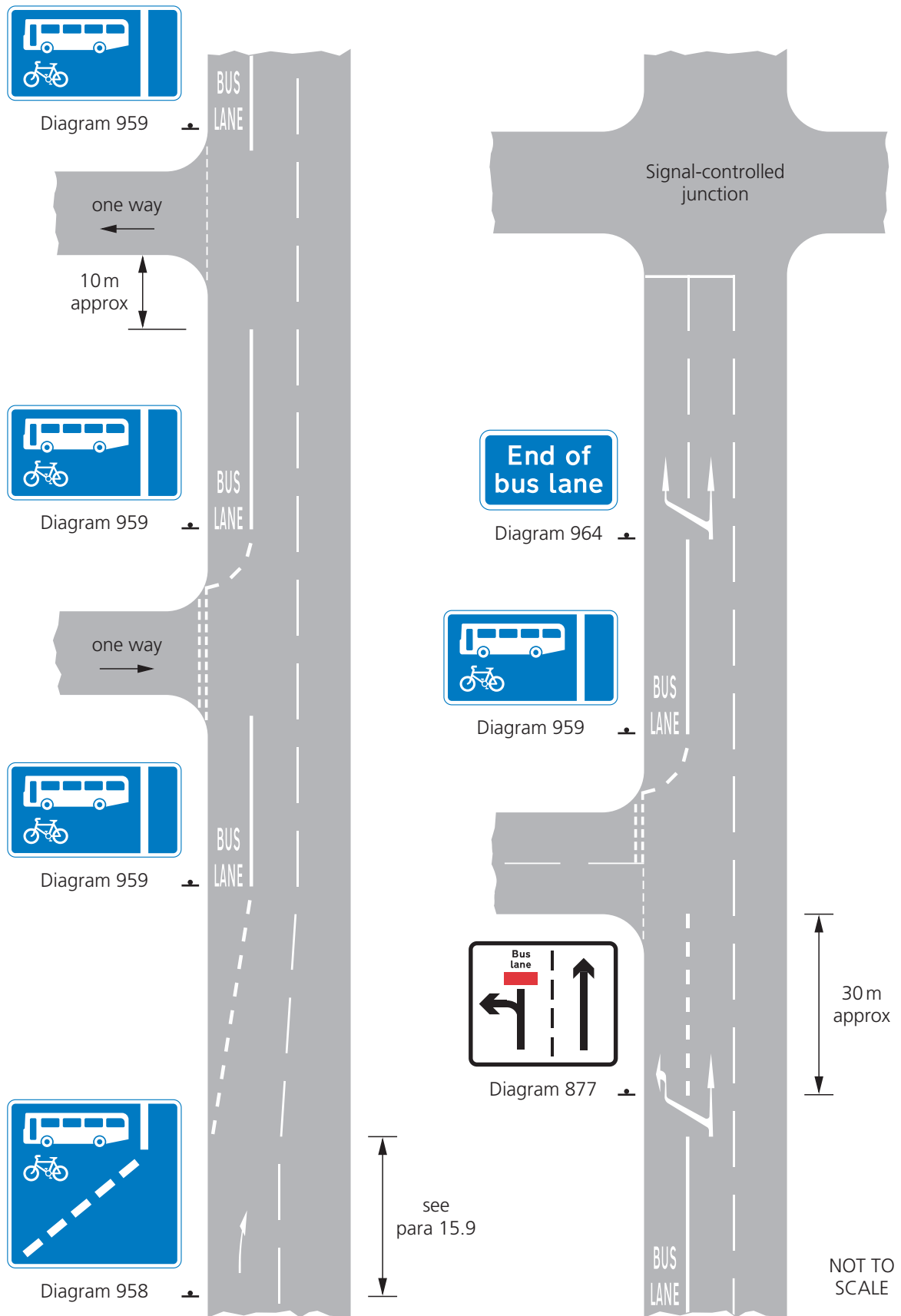
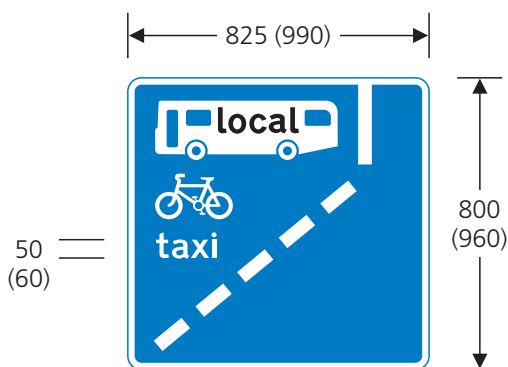
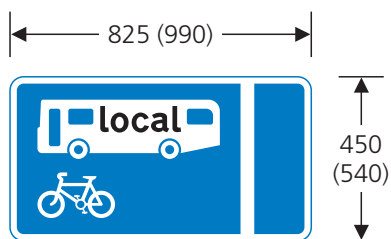

Figure 15-1 Example of signing a with-flow bus lane



958 With-flow bus lane ahead that may be used by the vehicles indicated on the sign

May be used with diagram 961. The word "taxi" may be omitted. The local bus symbol may be varied to the bus symbol shown in diagram 960



959 With-flow bus lane that may be used by the vehicles indicated on the sign

May be used with diagram 961. The word "taxi" in white letters may be added alongside the cycle symbol. The local bus symbol may be varied to the bus symbol shown in diagram 960

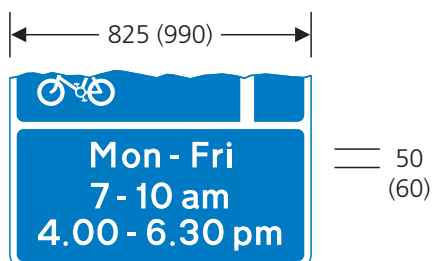

961 Times of operation of a with-flow bus lane or cycle lane

May be used only in combination with diagrams 958, 958.1, 959 and 959.1. Times and days of the week may be varied. The legend may be varied to "At any time"

15.11 The signs to diagrams 958 and 959 should indicate the type of vehicles that are allowed to use the lane, i.e. they must show the bus symbol, with or without the legend "local", the cycle symbol and, optionally, the legend "taxi" (see para 15.1). The legend "local" on the bus symbol indicates that the lane may be used only by those buses operating a local service as defined in regulation 4 (see also regulation 24(2)). The bus symbol without the legend "local" means that any bus, as defined in regulation 24(1), may use the lane. The detailed design of the signs to diagrams 958 and 959 and their variants is shown on the working drawings (see para 1.9).

15.12 Where a bus lane does not operate at all times, the signs to diagrams 958 and 959 should incorporate the sign to diagram 961 indicating the days and times of operation (see figure 15-2). Where there is more than one bus lane along a particular length of road or within the same geographical area, the times of operation should be consistent, where possible, to avoid driver confusion. The width of diagram 961 is the same as diagrams 958 and 959; it cannot be made any narrower or wider, nor can the width of diagrams 958 and 959 be varied to

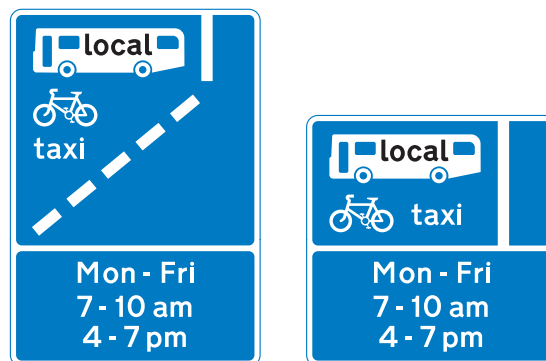

Figure 15-2 Part-time bus lane (see para 15.12)

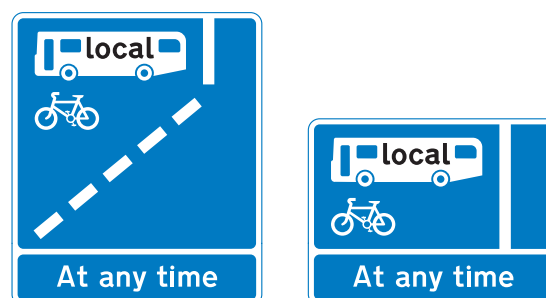

Figure 15-3 24-hour bus lane; lower panel normally omitted (see para 15.12)

accommodate diagram 961. Working drawing P 961 (see para 1.9) shows how to accommodate the time period within the fixed width of the sign. Time periods should be expressed in the manner described in Chapter 7, paras 12.5 to 12.13. The time may be varied to "At any time", but this should be used only to avoid possible confusion where a 24-hour bus lane is introduced in the vicinity of another bus lane that does not operate at all times (see figure 15-3). A sign to diagram 958 or 959, when the time plate to diagram 961 is not incorporated, means that the lane operates for 24 hours on every day of the week.

15.13 The end of a bus lane is indicated by a sign to diagram 964, sited as shown in figure 15-1.



964 End of bus lane

15.14 The signs to diagrams 958, 959, 961 and 964 are prescribed in two sizes. The smaller size should be used on roads with a speed limit of 20 mph or 30 mph. The larger size is for use on roads with a 40 mph speed limit. Where a bus lane is to be introduced on a road with a higher speed limit (e.g. a commuter route with little frontage development and a speed limit of 50 mph), an even larger size of sign is likely to be required. Also, the BUS LANE marking to diagram 1048 will need to use 2800 mm high letters instead of the 1600 mm high letters prescribed by the Regulations. Authorisation should be sought from the Department in these circumstances (see para 2.1).

15.15 Where a bus lane is interrupted to enable vehicles to use the left hand lane before turning left at a side road junction, a road marking to diagram 1050, varied to indicate a left turn, should be provided (see para 17.8 in Chapter 5). This may be accompanied by a sign to diagram 877 as shown in figure 15-1. The legend "Except buses" on this sign should be varied to "Bus lane" to make it clear that other vehicles using the bus lane (i.e. cycles and, where permitted, taxis) may continue to use the left hand lane. When used on a primary route, the colour of the sign is varied to a green background with white arrows, legend and border. Four sizes are prescribed; the smallest should be used on roads with a speed limit of 20 mph or 30 mph. The next size is appropriate for roads with a 40 mph speed limit. The

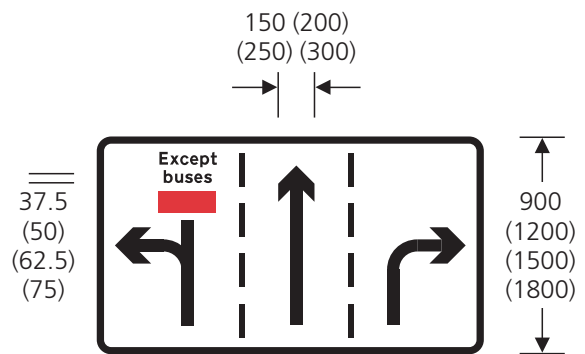

877 Appropriate traffic lanes for manoeuvres at junction ahead

"Except buses" may be varied to "Bus lane" (see working drawing for other variants)

two largest sizes are intended for use on roads with a speed limit greater than 40 mph, indicating lane allocation at junctions without bus lanes.

15.16 The sign to diagram 962 may be provided on side roads to warn emerging drivers of the presence of a with-flow bus lane on the major road. The sign should not be necessary where a bus lane commences downstream of the junction, provided that a driver turning into the major road would see a sign to diagram 958 in good time to react to it. The arrow on the sign indicates the direction of travel within the bus lane. The sign is most likely to be used where the bus lane is on the same side of the major road as the side road; in this case the arrow will point to the left. It will not normally be necessary to provide a sign where the bus lane is on the opposite side of the major road; in most cases the presence of the continuous line to diagram 1049 and a sign to diagram 959 should give adequate

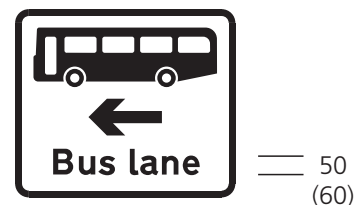

962 Bus lane on road at junction ahead

The bus symbol and arrow together may be reversed. The arrow may be omitted and the word "lane" varied to "lanes". The operational period of the bus lane may be added

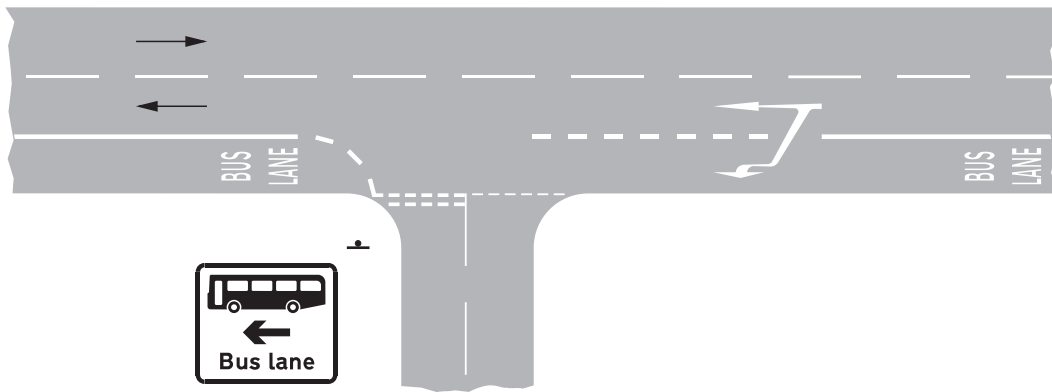

Diagram 962

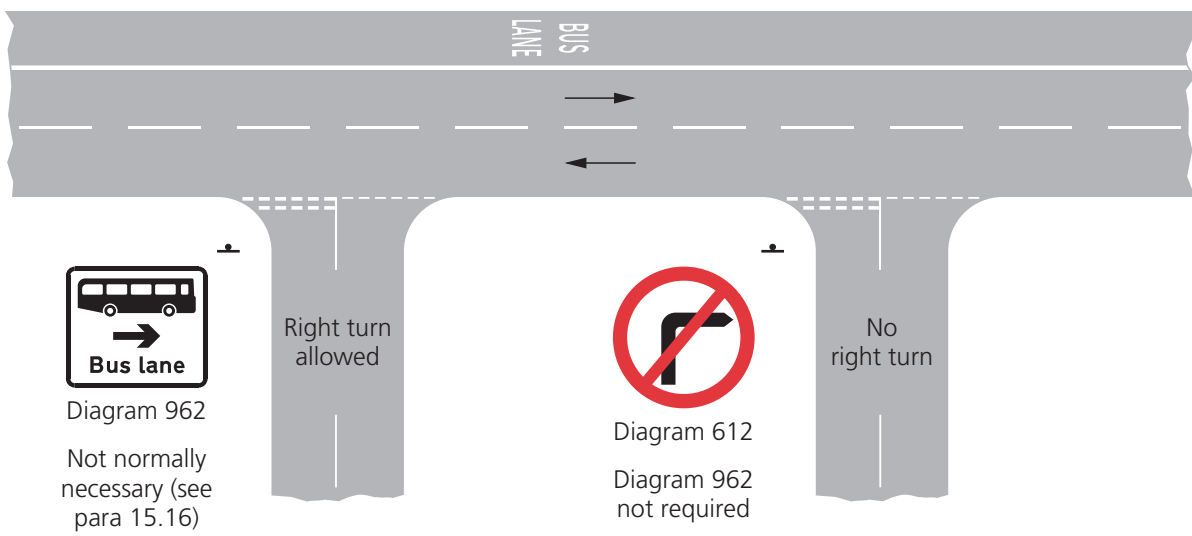

Diagram 962

Not normally necessary (see para 15.16)

Diagram 612

Diagram 962 not required

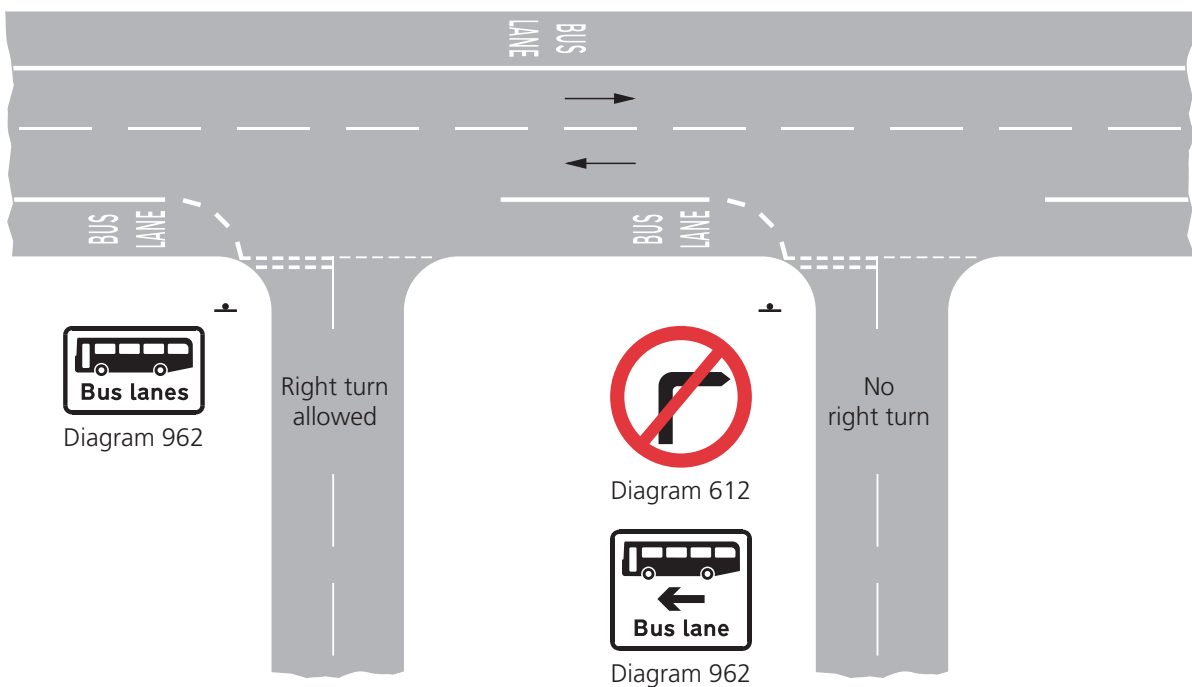

Diagram 962

Diagram 612

Diagram 962

Figure 15-4 Examples of the use of the sign to diagram 962 to indicate with-flow bus lanes

warning to drivers as they turn right at the junction. Drivers turning left at the junction do not need to be told that there is a bus lane on the opposite side of the road. Where there is a banned turn from the side road and this prevents traffic from turning into the major one in the direction of travel of the bus lane, a sign to diagram 962 should not be used. Where there are with-flow bus lanes on both sides of the major road and there are no banned turns, the arrow on diagram 962 is omitted and the word "lane" varied to "lanes". Where there are two bus lanes in the major road and the right turn from the side road is prohibited, the sign to diagram 962 should indicate only the bus lane to the left (i.e. the sign should include a left turn arrow and the legend should be "Bus lane" and not "Bus lanes"). Figure 15-4 shows examples of the use of diagram 962.

15.17 Two sizes are prescribed for the sign to diagram 962; in most cases the smaller size will be sufficient. The sign should be mounted below any GIVE WAY or STOP sign or, if the junction is controlled by traffic signals, mounted a sufficient distance in advance of the junction so as not to obstruct the view of the signal head. The days and times of operation are shown on the sign where appropriate (see figure 15-5). For a 24-hour bus lane no times are shown; "At any time" is not a permitted variant. Where the sign has been varied to "Bus lanes" (see para 15.16) and the two lanes operate at different times, no time period should be shown. Drivers will be informed of the period of operation by the combined sign to diagrams 959 and 961 after turning into the major road.



Figure 15-5 Examples of diagram 962 showing with-flow bus lane operational period

CONTRA-FLOW BUS LANES

15.18 Contra-flow bus lanes should always be provided on the near side; an off side lane would result in traffic travelling on the wrong side of oncoming traffic. Even if the lane were physically

segregated, the effect would be disconcerting to drivers and at night dipped headlights might result in dazzle.

15.19 Figures 15-7 to 15-10 show typical examples of the signing requirements for a contra-flow bus lane. Guidance on the use of road markings is given in section 17 of Chapter 5. It should be noted that the appropriate marking in these cases is BUS LANE to either diagram 1048 or 1048.1, as it is being used to indicate a bus lane rather than used in conjunction with the sign to diagram 616 or 953. In accordance with direction 18(3), the marking is being used in conjunction with the continuous line to diagram 1049 and with the sign to diagram 960. The BUS ONLY marking to diagram 1048.3 or 1048.4 is not prescribed for use with bus lanes but only for bus-only streets or gates (see paras 15.29 to 15.32). Figure 15-11 shows the signs that may be provided to indicate the bus lane to traffic approaching from a side road.

15.20 A contra-flow bus lane is effectively a one-way road with a bus lane running in the opposite direction. The signs to diagram 652 (see paras 4.35 to 4.37), indicating to general traffic that the road is one way, are replaced by signs to diagram 960. These

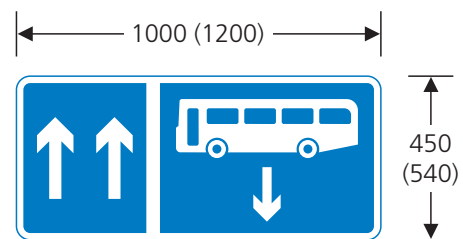

960 Contra-flow bus lane

The number of upward-pointing arrows may be varied. The cycle symbol may be added as shown in figure 15-6. The bus symbol may be varied to the local bus symbol shown in diagram 959

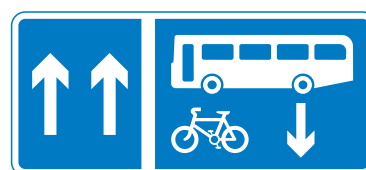

Figure 15-6 Contra-flow bus and cycle lane (permitted variant of diagram 960)

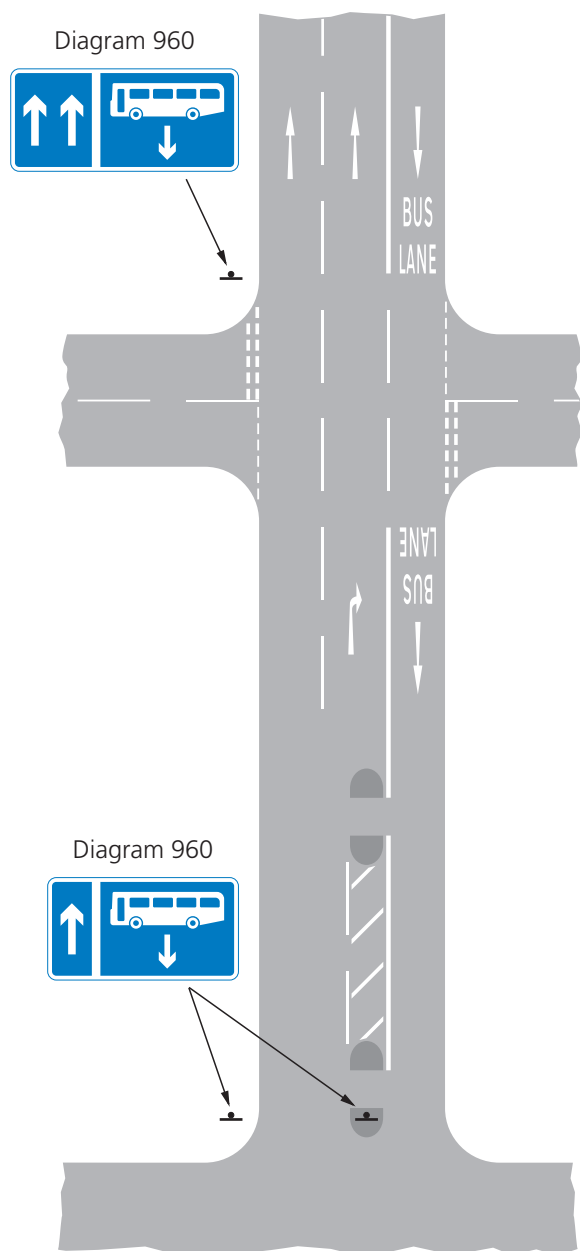

Figure 15-7 Example of signs indicating contra-flow bus lane to other drivers

should be located at the beginning of the road and after every junction, in each case on the near side and on any central refuge (see figure 15-7). Additional signs should be provided where the distance between them would otherwise exceed 300m. The number of arrows pointing upwards on the left hand side of the sign should be varied to indicate the number of lanes available in that direction. The bus symbol on the right hand side of the sign should be accompanied by the cycle symbol where the contra-flow bus lane is used also by pedal cycles (see figure 15-6).

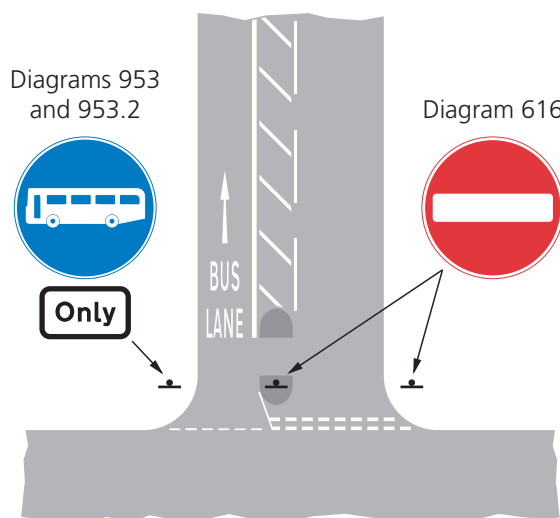

Figure 15-8 Start of contra-flow bus-only lane indicated by signs to diagrams 953 and 953.2

Direction 20(1) does not permit diagram 953 to be used without the "Only" plate to diagram 953.2

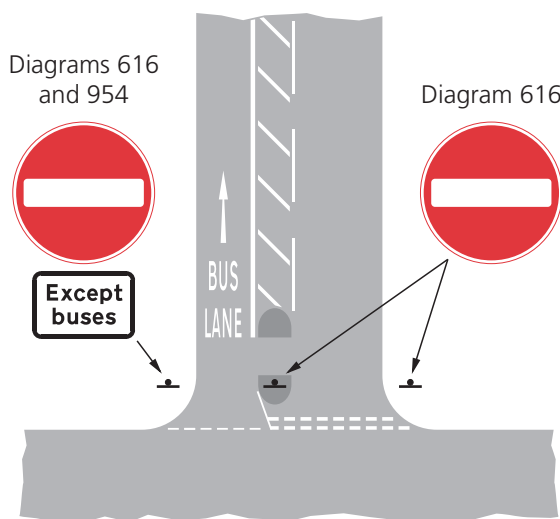

Figure 15-9 Start of contra-flow bus-only lane indicated by signs to diagrams 616 and 954

This is no longer the recommended method of indicating a contra-flow bus lane. The signs shown in figure 15-8 should normally be used

15.21 The start of the contra-flow lane should be separated from opposing traffic by a refuge in the centre of the road. The exit side of the road, used by all traffic, should be protected by "no entry" signs as for ordinary one-way roads (see paras 4.39 to 4.43). Where a bollard is provided on the refuge, this may

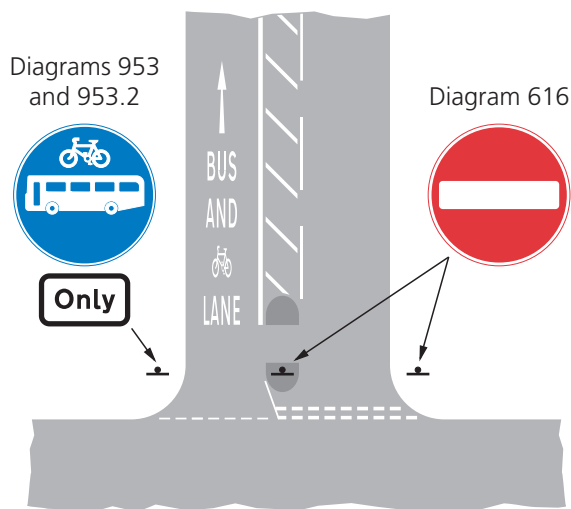
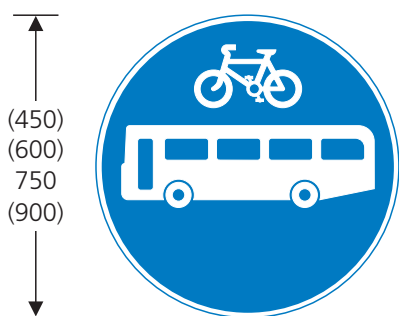

Figure 15-10 Start of a contra-flow bus and cycle lane



953 Route for use by buses and pedal cycles only

May be used only in combination with diagram 953.2. The bus symbol may be varied to the local bus symbol shown in diagram 959. The cycle symbol may be omitted. When used to indicate a bus gate (see paras 15.29 to 15.32), the word "taxi" in white letters may be added below the bus symbol



953.2 Plate for use with diagrams 953 and 953.1

May be used only in combination with diagram 953 or 953.1

include a "no entry" sign, but a full-size sign must also be provided. Historically, a contra-flow bus-only lane has been signed with a "no entry" sign to diagram 616 and a supplementary plate to either diagram 954 (Except buses) or 954.2 (Except local buses) as shown in figure 15-9. However, in future the sign to diagram 953 with the "Only" plate to diagram 953.2 should be used, as shown in figure 15-8. This is the only arrangement that is prescribed for bus and cycle contra-flow lanes, with diagram 953 varied to include the cycle symbol (see figure 15-10). Direction 21(2) prohibits the use of the "Except buses and cycles" plate with the "no entry" sign. Not only is using diagram 953 to indicate a bus-only lane consistent with the signing of a bus and cycle lane, it also helps to prevent the meaning of the "no entry" sign from being diluted. The main purpose of diagram 616 is to protect the exit from a one-way road, where drivers travelling in the opposite direction would put themselves and others at risk (see also para 4.42). "End of bus lane" signs to diagram 964 are not used with contra-flow lanes, nor are time plates, as these lanes operate continuously.

15.22 Two sizes are prescribed for the sign to diagram 960. The smaller size will usually be adequate. The larger size might be more appropriate where there are more than two lanes for general traffic or where there is a particular conspicuity problem. The "no entry" sign to diagram 616 should be 750mm in diameter with the supplementary plate having an x-height of 62.5mm. Where the sign to diagram 953 is used, this should normally be 750mm in diameter with the supplementary plate having an x-height of 75mm.

15.23 Where central islands are provided along the lane, these should have "keep left" signs to diagram 610 in both directions, as they would on any two-way road.

15.24 The sign to diagram 962 should be provided on side roads to warn emerging drivers of the presence of a contra-flow bus lane on the major road. If cycles are also permitted to use the lane, the sign to diagram 962.2 should be used instead. For a bus lane on the same side of the major road as the side road, the arrow will point to the left. The sign should be accompanied by the "no left turn" sign to diagram 613. Where buses and, if appropriate, cycles are permitted to turn left into the bus lane, the "no left turn" sign should have a supplementary plate "Except buses" (diagram 954 or 954.5), "Except local buses" (diagram 954.2 or 954.6), "Except buses and

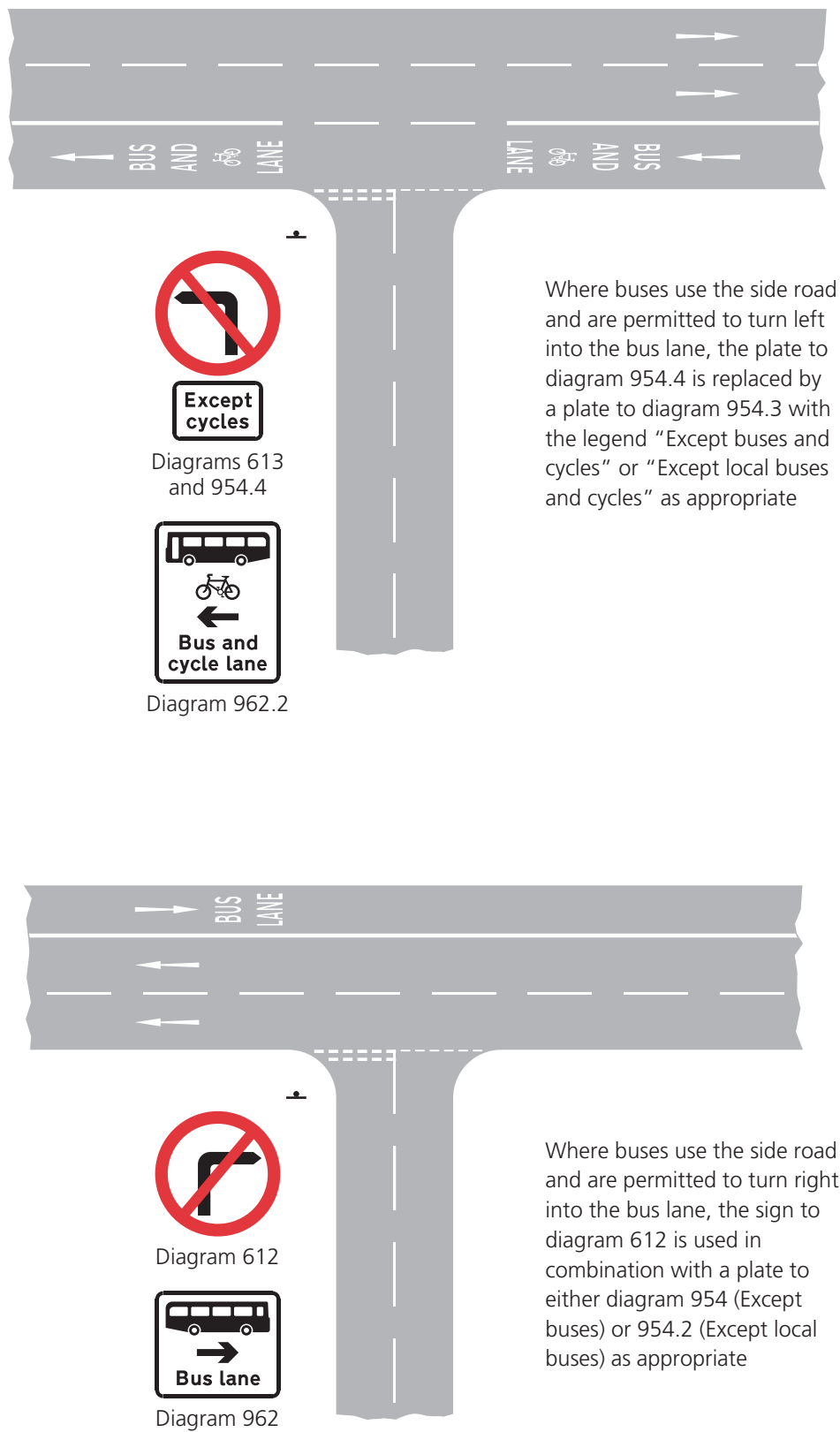
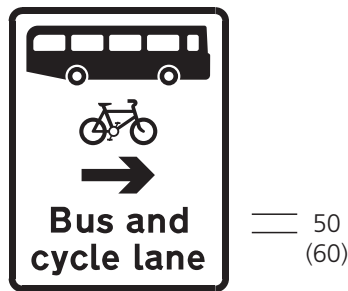

Figure 15-11 Examples of the use of the signs to diagrams 962 and 962.2 to indicate contra-flow bus lanes



962.2 Contra-flow bus and cycle lane on road at junction ahead

The bus symbol, cycle symbol and arrow together may be reversed

cycles" (diagram 954.3 or 954.6) or "Except local buses and cycles" (diagram 954.3 or 954.7) (see para 4.14). Where the bus lane is on the opposite side of the major road, the arrow on the sign to diagram 962 or 962.2 will point to the right. A "no right turn" sign to diagram 612 should be provided and, where buses and cycles are permitted to turn right to enter the lane, used with an appropriate supplementary plate (as for the "no left turn" sign above). Examples of the use of diagrams 962 and 962.2 are shown in figure 15-11.

15.25 Two sizes are prescribed for the signs to diagram 962 and 962.2; in most cases the smaller size will be sufficient. The sign should be mounted below any GIVE WAY or STOP sign or, if the junction is controlled by traffic signals, mounted a sufficient distance in advance of the junction so as not to obstruct the view of the signal head.

SIGNS FOR PEDESTRIANS

15.26 The signs shown in diagrams 963 and 963.2 warn pedestrians of the presence of a bus lane. The signs should not be used as a substitute for diagrams 962 and 962.2 to warn drivers approaching the bus lane from a side road (see paras 15.16 and 15.24). The signs would normally be used for contra-flow bus lanes at locations where pedestrians might not realise that traffic travels in both directions, especially where a lane is introduced into a street where traffic was previously one way only. The sign to diagram 963 should be used to warn of a contra-flow lane used by buses only, and diagram 963.2 for a contra-flow lane used by both buses and cycles. Should it be necessary to warn of a with-flow lane, the sign to diagram 963,



963 Bus lane with traffic proceeding from right (Sign for pedestrians)

"RIGHT" may be varied to "LEFT" and the bus symbol reversed as shown in figure 15-12. "LANE" may be varied to "LANES" and "RIGHT" varied to "BOTH WAYS"

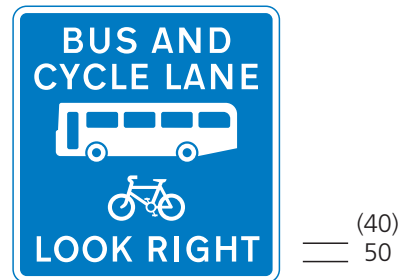

963.2 Contra-flow bus and cycle lane with traffic proceeding from right (Sign for pedestrians)

"RIGHT" may be varied to "LEFT" and the bus and cycle symbols reversed (bus symbol as shown in figure 15-12). "LANE" may be varied to "LANES" and "RIGHT" varied to "BOTH WAYS"

and not 963.2, should be used, even though cycles will be using the lane. The sign to diagram 963.2 is prescribed for use with contra-flow lanes only. It should be noted that pedestrian signs indicating the operational period of a with-flow bus lane or that taxis use the lane are not prescribed.

15.27 The signs should be sited where the majority of pedestrians cross the carriageway, and always adjacent to the bus lane. A sign should not be sited where it might encourage pedestrians to look the wrong way when stepping into the road, e.g. where pedestrians first cross a general traffic lane flowing in the opposite direction to the bus lane. Where pedestrians cross a road that has a contra-flow bus lane, a central refuge adjacent to the lane should be provided. The sign to diagram 963 or 963.2, varied to LOOK LEFT with the symbols facing right, should be

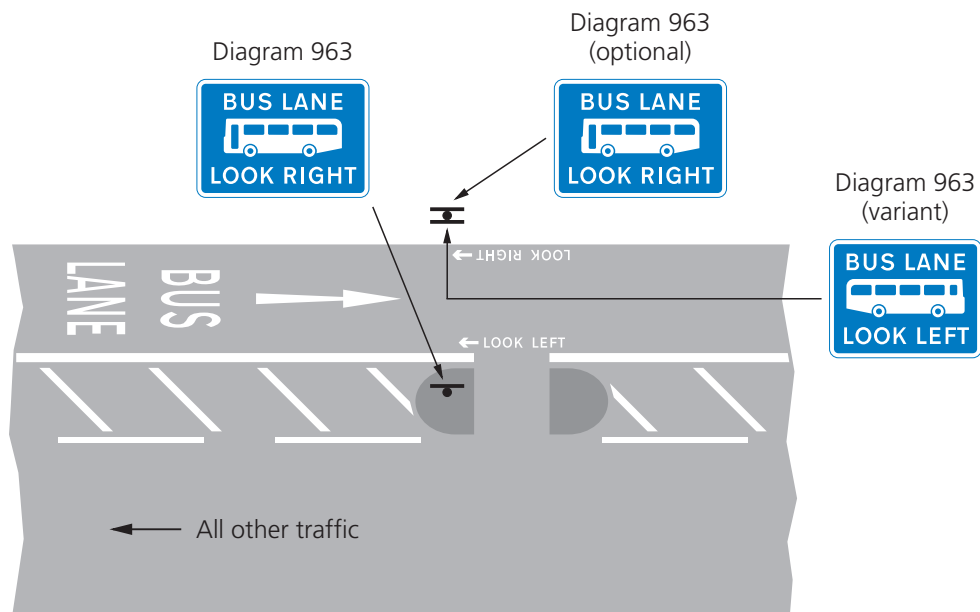

Figure 15-12 Example of the use of pedestrian signs to diagram 963 to indicate a contra-flow bus lane

located opposite the refuge as shown in figure 15-12. The signs may be varied to LANES and LOOK BOTH WAYS, but these versions are unlikely to be required.

15.28 Two sizes are prescribed for the signs to diagrams 963 and 963.2. The larger size, with a 50 mm x-height, should normally be used. The smaller sign, with a 40 mm x-height, may be more suitable where there are space constraints, such as on a pedestrian refuge.

BUS-ONLY STREETS AND BUS GATES

15.29 Where either a one-way or two-way road is reserved for buses and cycles, the entry points should be indicated by signs to diagram 953. The other end of a one-way road must have “no entry” signs to diagram 616 in accordance with paras 4.39 to 4.41. Where the order permits taxis to use the road or excludes cycles, the sign to diagram 953 shall be varied accordingly. As with contra-flow bus lanes, this sign must be used in combination with the “Only” plate to diagram 953.2. Where the road is for the exclusive use of buses, the sign to diagram 953 is varied to show only the bus symbol. The “no entry” sign to diagram 616, with an “Except buses” plate, is not appropriate in this case as this combination should be used only for contra-flow bus lanes within a one-way street (see para 15.21). Where access to premises is required for other vehicles or where the

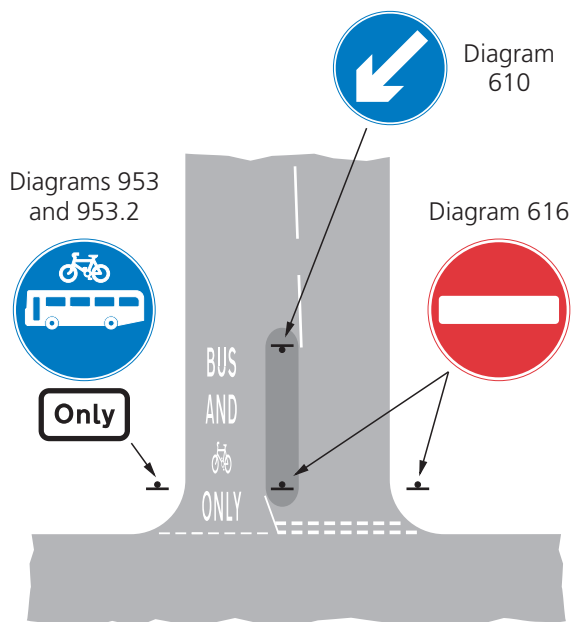

Figure 15-13 One-way bus gate on a two-way road

bus-only restriction does not apply at all times, a sign to diagram 619 (no motor vehicles) with an exception plate to diagram 620 should be used (see paras 5.9 to 5.12). The plate should have the legend “Except buses and for access” and, if appropriate, include a time period. “buses” may be varied to “local buses”.

Where cycles are prohibited, the sign to diagram 617 (no vehicles) with an exception plate to diagram 618.1 should be used (see paras 5.5 and 5.7).

15.30 A bus gate is a short length of bus-only street (see para 15.4). On a two-way road, access may be restricted to buses in one direction only, with all traffic permitted in the opposite direction, i.e. similar to a contra-flow lane, but too short to be signed as such. In this case, that part of the carriageway reserved for buses should be separated from the opposing flow of traffic by a traffic island and not by a continuous line marking to diagram 1049 (see figure 15-13). Bus gates are often used to remove through traffic from a road but allow full access. They effectively create a “no through road” for all traffic other than buses. The bus gate may be located either at a junction or part way along a road, and may be used by pedal cycles and taxis where permitted by the order. An example is shown in figure 15-14.

15.31 A bus gate is signed in a similar manner to a bus-only street, using signs to diagrams 953 and 953.2. Where the bus gate is a short length of one-way road which leads to a two-way road used by all traffic, the opposite end of the gate must have “no entry” signs to diagram 616.

15.32 The appropriate road markings for bus-only streets and bus gates are diagrams 1048.3 BUS ONLY and 1048.4 BUS AND (cycle symbol) ONLY. The latter may be varied to BUS AND TAXI ONLY or BUS TAXI (cycle symbol) ONLY. “AND” may be varied to “&” when the legend is on three lines. No markings are prescribed for use with the supplementary plates to diagrams 618.1 and 620. This would not be practicable; the descriptions of possible exceptions can be lengthy (see paras 5.5 to 5.12), and moreover these might apply only at certain times.

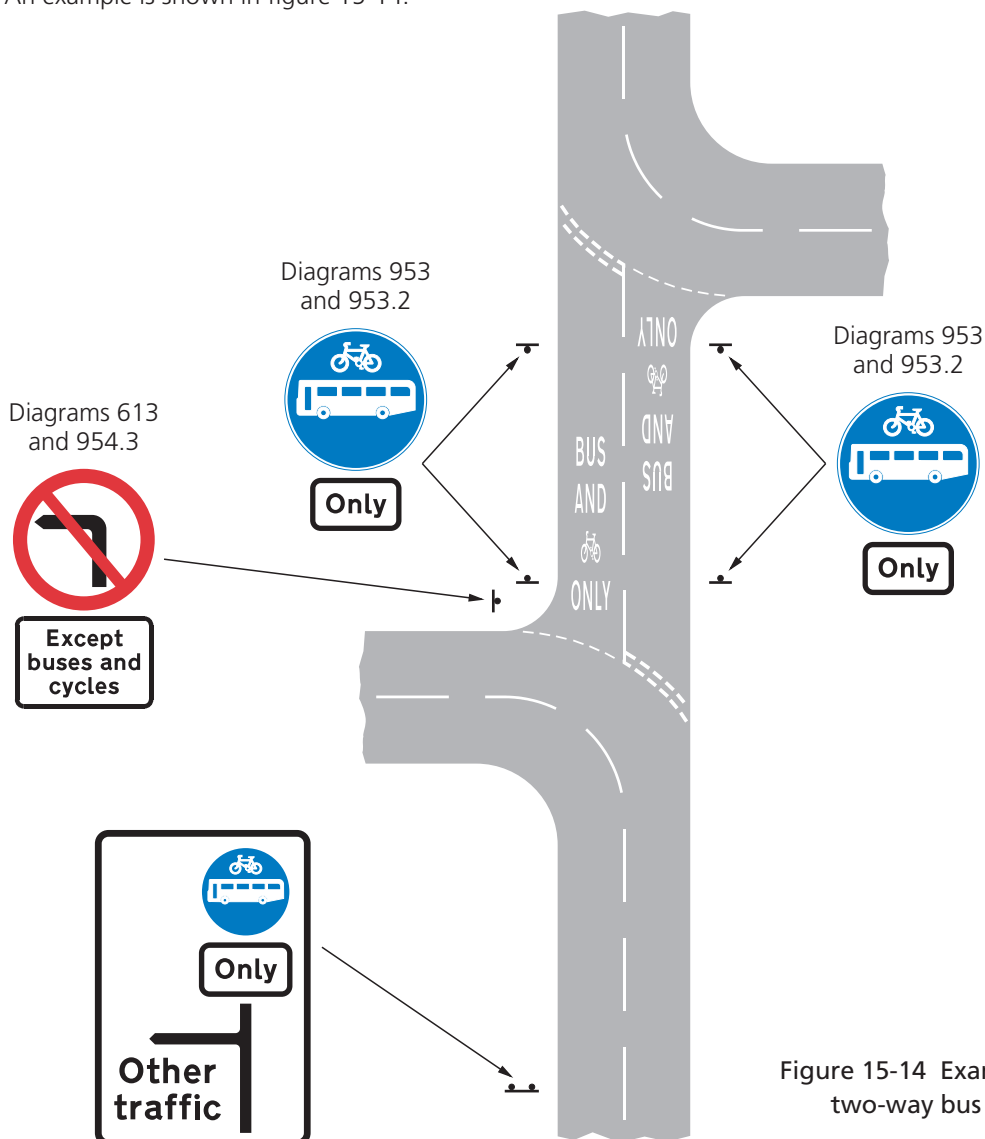

Figure 15-14 Example of a two-way bus gate

16 TRAM SIGNS

GENERAL

16.1 The general principles for signing and marking tramways, including the use of variants to diagram 976 (see para 14.49), are set out in HM Railway Inspectorate's "Railway Safety Publication 2, Guidance on Tramways" published on the Office of Rail Regulation website. Early contact should be made with the Inspectorate to discuss requirements. The following paragraphs give more detailed guidance on the use of traffic signs for street-running tramways.

16.2 At a priority junction, where trams share the major road with other traffic, STOP or GIVE WAY signs for the minor road should be provided in accordance with section 3. Warning signs for tramway crossings are covered in section 21 of Chapter 4. Details of road markings for tramways can be found in section 18 of Chapter 5. Para 14.49 in this chapter deals with speed limit signs for trams.

SIGNS FOR TRAM-ONLY ROUTES

16.3 Where an on-street tramway enters a tram gate (or tram-only road), a segregated on-street tram route or an off-street tram route, signs to diagram 953.1 in combination with the "Only" plate to diagram 953.2 are provided. A "no entry" sign to diagram 616 cannot be used instead of diagram 953.1, as there is no prescribed supplementary plate with the legend "Except trams".

16.4 A tram gate is similar to a bus-only street or bus gate described in paras 15.29 to 15.32. Buses may share a tram gate, in which case the sign to diagram 953.1 is varied to include the bus symbol (normally the local bus symbol) as shown on working drawing P 953.1 (see para 1.9). The sign must not be varied to include the cycle symbol or the legend "taxi". Although cycles and taxis may be permitted to use a bus gate, there are safety issues with a tram gate.

16.5 The sign to diagram 953.1 should normally be 750 mm in diameter with the supplementary plate having an x-height of 75 mm. The largest sign size of 900 mm is likely to be more appropriate where a tramway leaves the public highway to enter an off-street route or at other locations where greater emphasis is required to ensure that drivers follow the correct route through a complex junction. The smaller sizes might be appropriate where traffic speeds are low and where access to traffic is generally restricted (e.g. where a tramway crosses a pedestrian zone).

16.6 A segregated on-street tram route is similar to a bus lane except that physical separation is provided between the tramway and that part of the road used by other traffic. No other traffic should be allowed to use the tramway, although it may be crossed by pedestrians. Figure 16-1 shows an example of each end of a one-way road used by all traffic, including trams, with a contra-flow segregated tramway. Figure 16-2 shows an example of a tramway leaving the public highway to enter an off-street route.

16.7 In certain situations it might be appropriate to provide a "keep left" or "keep right" sign to diagram 610 to guide other traffic away from a route used exclusively by trams, whether on-street or off-street. Regulation 15(3) exempts trams from the requirement to comply with such a sign.

16.8 An advance direction sign may indicate a route for trams only, as shown in figures 16-1 and 16-2.

16.9 There are no prescribed signs for a bus lane that is used also by trams. Where such provision is required, an application for sign authorisation should be submitted to the Department (see para 2.1).

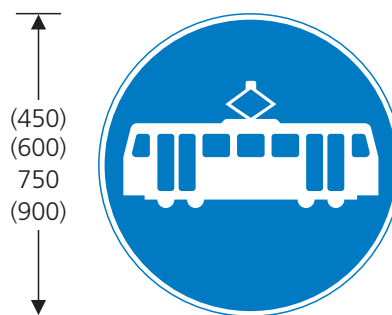

953.1 Route for use by tramcars only

May be used only in combination with diagram 953.2. The bus symbol shown in diagram 953 or the local bus symbol shown in diagram 958 may be added below the tramcar symbol



953.2 Plate for use with diagrams 953 and 953.1

May be used only in combination with diagram 953 or 953.1

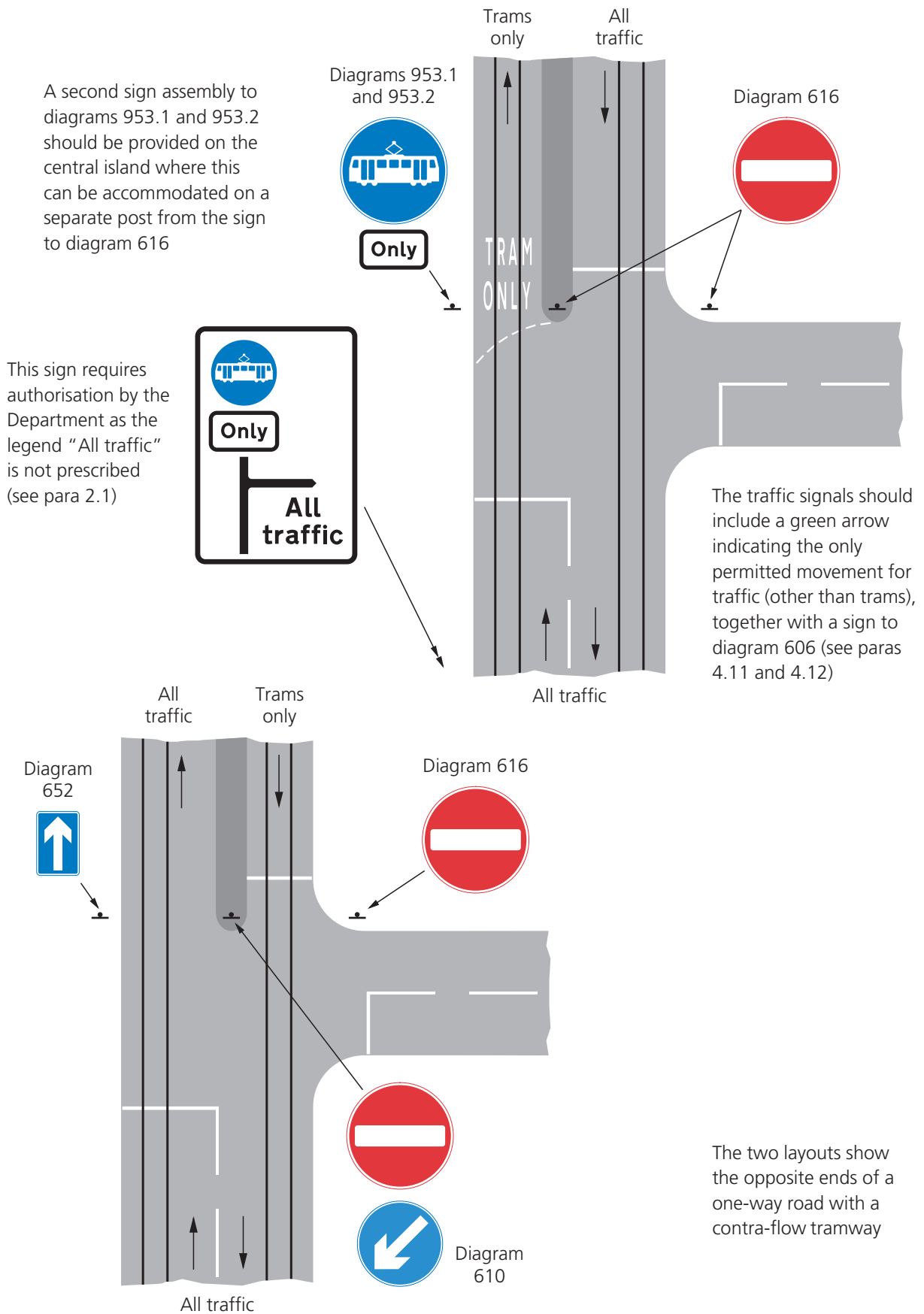

Figure 16-1 Example of a one-way road used by all traffic with a segregated contra-flow tramway

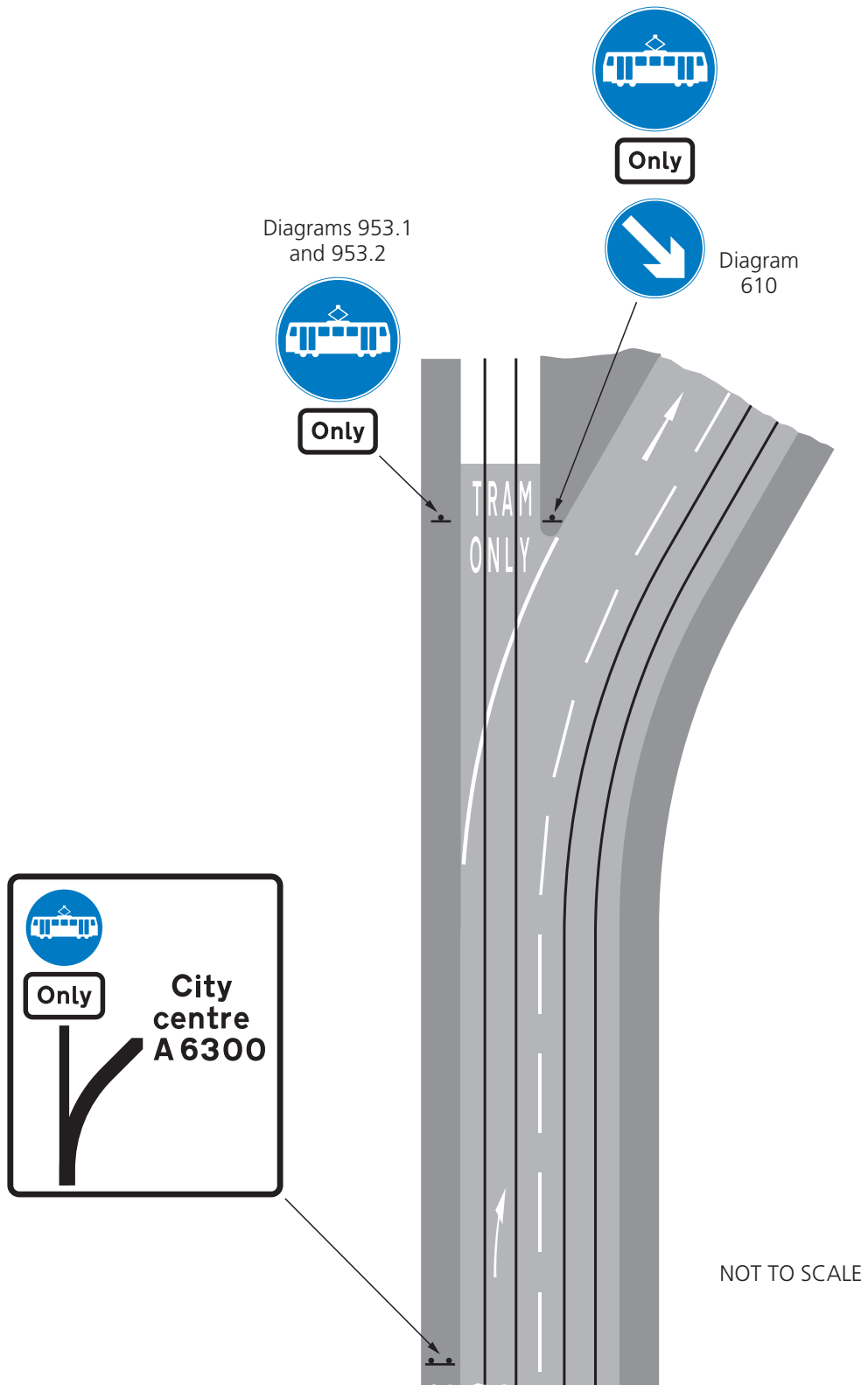
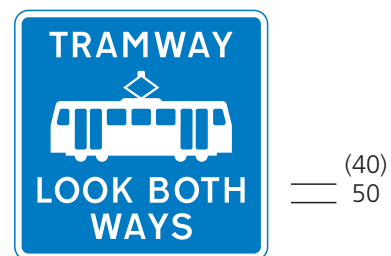

Figure 16-2 Example of a tramway leading from a public highway to an off-street route

PEDESTRIAN SIGNS

16.10 The sign shown in diagram 963.3 warns pedestrians of the presence of a tramway. The legend below the tram symbol may be varied to LOOK LEFT or LOOK RIGHT. These variants would be appropriate where trams travelling in opposite directions are separated by a pedestrian refuge or where the tramway is one way. Signs should be sited where the majority of pedestrians cross a tram route.

16.11 Two sizes are prescribed for the sign to diagram 963.3. The larger size, with a 50 mm x-height, should normally be used. The smaller sign, with a 40 mm x-height, may be more suitable where there are space constraints, such as on a pedestrian refuge.



963.3 Tramway with traffic proceeding
in both directions
(Sign for pedestrians)

"BOTH WAYS" may be varied to "LEFT" or "RIGHT"

17 CYCLE FACILITIES

GENERAL

17.1 This section deals with the signing of cycle facilities, including cycle lanes and cycle routes shared with pedestrians. Detailed guidance on the use of road markings is given in section 16 of Chapter 5. For cycle parking place signs see para 7.7.

17.2 A mandatory cycle lane requires an order which prohibits other vehicles from using that part of the carriageway while the lane is in operation. It may be either a with-flow lane or, in a one-way road, a contra-flow lane. The latter must be operational at all times, but a with-flow cycle lane may operate for only part of the day. Advisory lanes do not require an order and may be used in situations where mandatory lanes would be too restrictive, typically where road width is restricted and motor vehicles might occasionally need to encroach on the lane. They are often used as lead-in lanes to advanced cycle stop lines at junctions controlled by traffic signals (see para 17.13 in this section and paras 16.20 to 16.22 in Chapter 5) where it is not practicable to introduce a mandatory lane. They may also be used to by-pass parking bays as shown in figure 16-3 in Chapter 5. Contra-flow advisory cycle lanes may be introduced in one-way streets, but special sign authorisation is required (see para 17.25).

WAITING AND LOADING RESTRICTIONS

17.3 Waiting should be prohibited during the operational periods of a mandatory cycle lane as it is an offence for motor vehicles to enter the lane. Signs and markings, provided in accordance with section 6, are required only where an order is made to prohibit waiting during any period when the cycle lane is not in force. The time period shown on the upright signs should not overlap the operational period of the lane; the road markings will therefore be to diagram 1017 (single yellow line) even if the combined effect results in a 24-hour prohibition of waiting.

17.4 Loading should also be banned in a mandatory cycle lane, although there may occasionally be special reasons why it needs to be allowed, such as off-peak loading in a 24-hour with-flow cycle lane. Any prohibition of loading, whether during or outside the hours when the lane is in force, should always be indicated with signs and markings in accordance with section 6, but without the need

also to indicate a prohibition of waiting unless waiting is prohibited outside the operational period of the lane.

MANDATORY WITH-FLOW CYCLE LANES

17.5 A mandatory cycle lane is marked with a continuous line to diagram 1049. Figure 17-1 shows a typical layout. Regulation 4 requires that a cycle lane commences with a road marking to diagram 1009. This is laid diagonally across the carriageway to guide motor vehicles away from the lane. A taper of 1:10 is recommended. Warning of the cycle lane should normally be given in advance of this taper by a sign to diagram 958.1. Where the speed limit is 20 mph or 30 mph, the sign should be sited 20 m in advance of the taper, with a minimum clear visibility distance of 45 m. Where the speed limit is 40 mph, the sign should be sited 40 m in advance of the taper with a minimum clear visibility distance of 60 m. Where siting of the sign is likely to be difficult and where the cycle lane is clearly visible to drivers, the sign to diagram 958.1 may be omitted. However, in the interests of road safety, the sign should be provided wherever possible. It must be used only in conjunction with the road marking to diagram 1009 (direction 17). It is not appropriate to use the sign at intermediate junctions along the cycle lane.

17.6 A sign to diagram 959.1 should be provided at the start of the continuous line denoting the edge of the cycle lane (i.e. immediately following the taper described in para 17.5). This is a regulatory sign that prohibits motor vehicles from encroaching on the cycle lane. The sign should be provided after each road junction on the same side as the cycle lane, even if the side road is one way leading away from the major road. The sign should also be provided after a junction on the opposite side of the road if vehicles can turn right from it to join the flow of traffic alongside the cycle lane. No two signs should be more than 300 m apart; it might be necessary, therefore, to provide additional signs between junctions.

17.7 Where a cycle lane does not operate at all times, the signs to diagram 958.1 and 959.1 should incorporate the sign to diagram 961 indicating the days and times of operation. The width of diagram 961 is the same as diagrams 958.1 and 959.1; it cannot be made any narrower or wider, nor can the width of diagrams 958.1 and 959.1 be varied to accommodate diagram 961. Working drawing

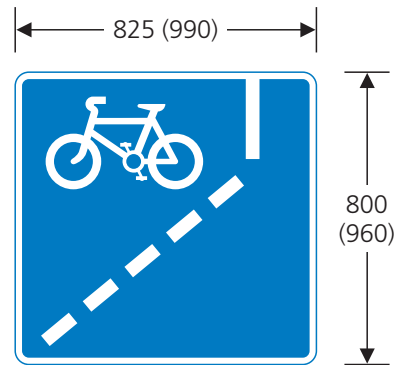
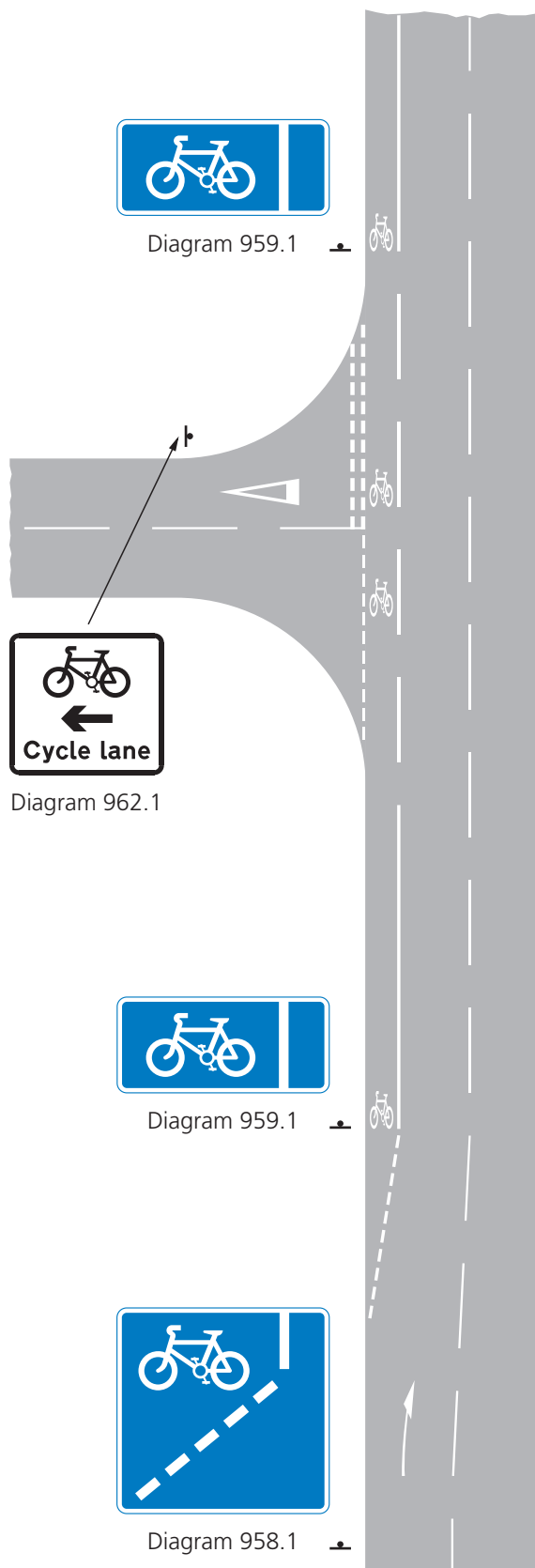

958.1 Mandatory with-flow cycle lane ahead

May be used with diagram 961

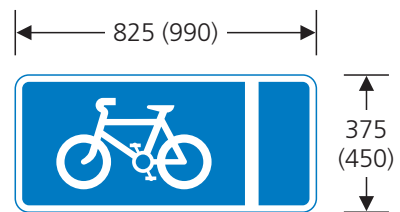

959.1 Mandatory with-flow cycle lane

May be used with diagram 961

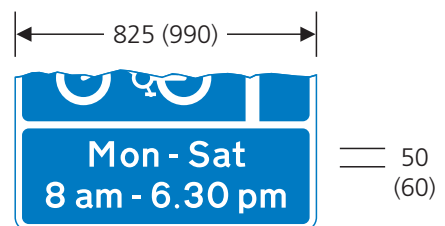

961 Times of operation of a with-flow bus lane or cycle lane

May be used only in combination with diagrams 958, 958.1, 959 and 959.1. Times and days of the week may be varied

Figure 17-1 Example of signing a mandatory with-flow cycle lane

P961 (see para 1.9) shows how to accommodate the time period within the fixed width of the sign. Time periods should be expressed in the manner described in Chapter 7, paras 12.5 to 12.13. Although the time may be varied to “At any time”, this would not normally apply to cycle lanes. It is intended for bus lanes to avoid possible confusion where a 24-hour bus lane is introduced in the vicinity of another bus lane that does not operate at all times (see para 15.12). A sign to diagram 958.1 or 959.1, when the time plate to diagram 961 is not incorporated, already means that the cycle lane operates for 24 hours on every day of the week.

17.8 The signs to diagrams 958.1, 959.1 and 961 are prescribed in two sizes. The smaller size should be used on roads with a speed limit of 20 mph or 30 mph. The larger size is for use on roads with higher speed limits.

17.9 The sign to diagram 962.1 is intended mainly for use in conjunction with contra-flow cycle lanes (see para 17.21). However, it may be provided on side roads, as shown in figure 17-1, to warn emerging drivers of the presence of a with-flow cycle lane on the major road, although this is not essential. The arrow on the sign indicates the direction of travel within the cycle lane and will normally point to the left, as a sign is not required to indicate a lane on the opposite side of the road. However, where there are with-flow cycle lanes on both sides of the major road and there are no banned turns, the arrow on diagram 962.1 is omitted and the word “lane” varied to “lanes”. Where there are two cycle lanes in the major road and the right turn from the side road is prohibited, the sign to diagram 962.1 should indicate only the cycle lane to the left.

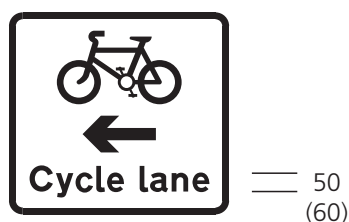

962.1 Cycle lane on road at junction ahead

The cycle symbol and arrow together may be reversed. “lane” may be varied to “track”. The arrow may be omitted and the word “lane” varied to “lanes”, “track” or “tracks”. The operational period of the cycle lane may be added

17.10 Two sizes are prescribed for the sign to diagram 962.1; in most cases the smaller size will be sufficient. The sign should be mounted below any GIVE WAY or STOP sign or, if the junction is controlled by traffic signals, mounted a sufficient distance in advance of the junction so as not to obstruct the view of the signal head. The days and times of operation may be shown on the sign where appropriate. For a 24-hour cycle lane no times are shown; “At any time” is not a permitted variant. Where the sign has been varied to “Cycle lanes” (see para 17.9) and the two lanes operate at different times, no time period should be shown. Drivers will be informed of the period of operation by the combined sign to diagrams 959.1 and 961 after turning into the major road.

17.11 The end of the cycle lane is normally indicated by the termination of the continuous white line to diagram 1049, although the road markings to diagram 1057 (cycle symbol) and diagram 1058 (END) may be used. The “end of cycle route” sign to diagram 965 (see para 17.36) is not intended to indicate the end of a cycle lane, although it might be helpful if a lane ends at a hazardous location where cyclists would need to take extra care.

ADVISORY WITH-FLOW CYCLE LANES

17.12 The boundary of an advisory with-flow cycle lane is indicated by a hazard warning line to either diagram 1004 or 1004.1 (see para 16.9 in Chapter 5). The start of the lane must commence with diagram 1009 (regulation 4) laid diagonally across the carriageway. The taper may be much shorter than that for a mandatory with-flow cycle lane (see para 16.10 in Chapter 5). An advance upright sign is not prescribed for advisory lanes. The sign to diagram 958.1 indicates a mandatory lane, and must not be used.

17.13 The sign to diagram 967 is used to indicate an advisory with-flow cycle lane. It should be provided at the start of the lane, immediately after the taper, and after each road junction on the same side as the cycle lane, even if the side road is one way leading away from the major road. The sign should also be provided after a junction on the opposite side of the road if vehicles can turn right from it to join the flow of traffic alongside the cycle lane. No two signs should be more than 300 m apart; it might therefore be necessary to provide additional signs between junctions. Where the lane

is provided as a short approach to an advanced stop line, an upright sign is not required; the cycle symbol marking to diagram 1057 within the lane will be sufficient. This is the only occasion where direction 18(1) (item 11 in table 1) permits the marking to diagram 1057 to be used for a cycle facility where there are no upright signs. It is not practicable to provide a sign where the lane is in the centre of the carriageway. Advisory with-flow lanes are available at all times, and a time plate is therefore not used with the sign to diagram 967.

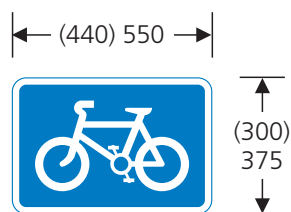

967 Route recommended for pedal cycles on the main carriageway of a road

17.14 The sign to diagram 967 is prescribed in two sizes. The smaller size should be used on roads with a speed limit of 20 mph or 30 mph. The larger size is for use on roads with higher limits.

17.15 As direction 7 does not apply to the sign shown in diagram 962.1, the sign may be provided on side roads to warn emerging drivers of the presence of an advisory with-flow cycle lane on the major road, although this is not essential. It should be used in a similar manner to that for mandatory with-flow cycle lanes (see paras 17.9 and 17.10).

17.16 The end of the cycle lane is normally indicated by the termination of the boundary line to diagram 1004 or 1004.1, although the road markings to diagram 1057 (cycle symbol) and diagram 1058 (END) may be used. The "end of cycle route" sign to diagram 965 (see para 17.36) is not intended to indicate the end of a cycle lane, although it might be helpful if a lane ends at a hazardous location where cyclists would need to take extra care.

MANDATORY CONTRA-FLOW CYCLE LANES

17.17 As with mandatory with-flow lanes, a mandatory contra-flow cycle lane is bounded by a continuous white line to diagram 1049 and all other

traffic is prohibited from entering that part of the carriageway. The order should establish a one-way street for all traffic, with a contra-flow lane for cyclists.

17.18 Figure 17-2 shows a typical entry to a one-way street and the repeater signs for general traffic. The "one-way traffic" signs to diagram 652 (see paras 4.35 to 4.37) are replaced by signs to diagram 960.1. These should be located at the beginning of the road and after every junction, in each case on both sides of the road. Additional signs should be provided where the distance between them would otherwise exceed 300m. Where a traffic island segregates traffic from the opposing cycle lane, the off side sign should be located on this island. The number of arrows pointing upwards on the left hand side of the sign should be varied to indicate the number of lanes available in that direction. Two sizes are prescribed for the sign to diagram 960.1. The smaller size will usually be adequate. The larger size might be more

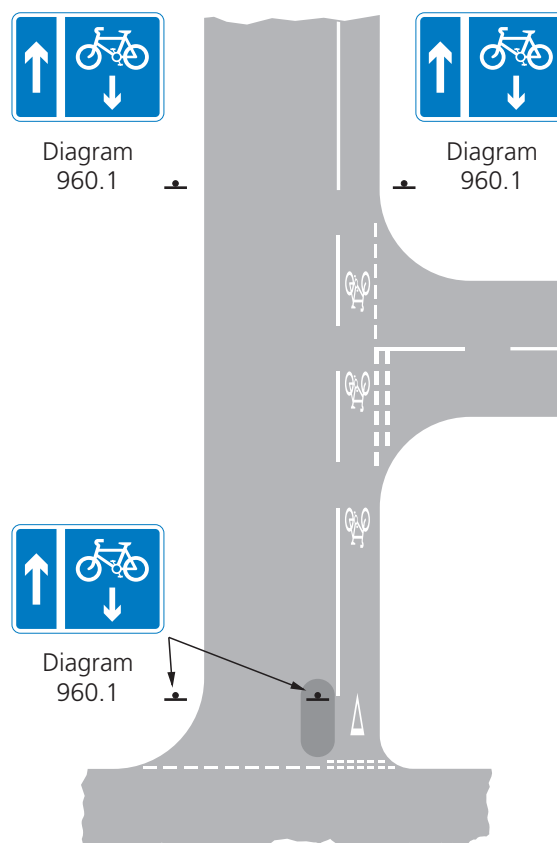
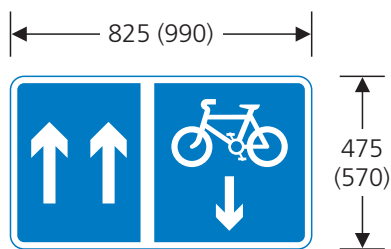

Figure 17-2 Example of signs indicating a mandatory contra-flow cycle lane to other drivers



960.1 Mandatory contra-flow cycle lane

The number of upward-pointing arrows may be varied

appropriate where there are more than two lanes for general traffic or where there is a particular conspicuity problem.

17.19 Figure 17-3 shows a typical arrangement at the start of a contra-flow cycle lane; this should be separated from opposing traffic by a traffic island in the centre of the road. The exit side of the road, used by all traffic, should be protected by a pair of “no entry” signs as for ordinary one-way roads (see paras 4.39 to 4.43). These should be 750 mm in diameter. A sign to diagram 955, with a diameter of 450 mm, should be provided on the left hand side of the road at the entrance to the contra-flow cycle lane. A second, smaller sign may be provided in a bollard on the traffic island.

17.20 Where segregating islands are provided along the lane, these should have “keep left” signs to diagram 610 in both directions, as they would on a two-way road. The end of the lane should be segregated from traffic entering the one-way street as shown in figure 17-2. “End of cycle route” signs to diagram 965 are not used with contra-flow lanes, nor are time plates, as these lanes operate continuously.

17.21 A sign to diagram 962.1 should be provided on side roads to warn emerging drivers of the presence of a contra-flow cycle lane on the major road, as shown in figure 17-4. For a cycle lane on the same side of the major road as the side road, the arrow will point to the left. The sign should be accompanied by the “no left turn” sign to diagram 613 with a supplementary plate “Except cycles” (diagram 954.4 or 954.5 variant) (see para 4.14). Where the cycle lane is on the opposite side of the major road, the arrow on the sign to diagram 962.1 will point to the right. A “no right turn” sign to

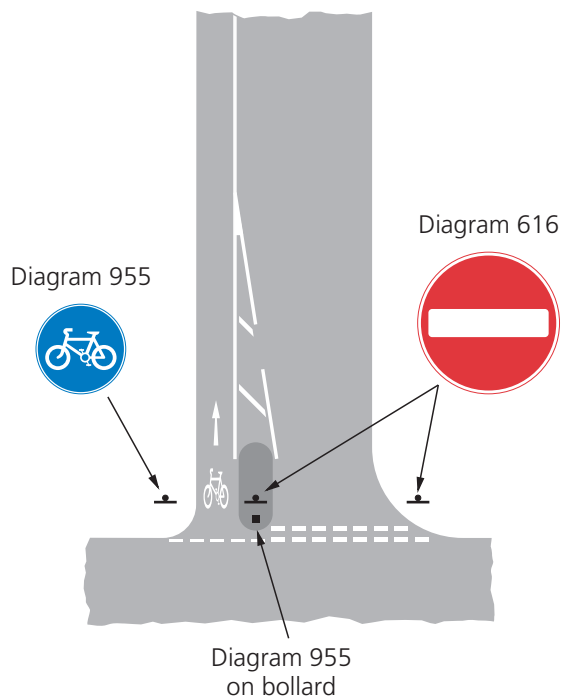
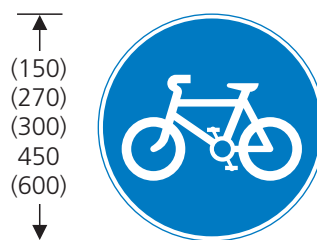

Figure 17-3 Start of a mandatory contra-flow cycle lane



955 Route for use by pedal cycles only

May be used in combination with the regional or national cycle route number plate shown in diagram 2602.3

diagram 612 should be provided, again with an “Except cycles” plate. If, for road safety reasons, the right turn ban also applies to cycles, the “Except cycles” plate and the sign to diagram 962.1 should be omitted. The presence of a sign to diagram 962.1 in this case might encourage cyclists to turn right into the cycle lane. If possible, the cycle lane should be segregated from the major road at the junction by a traffic island. The sign to diagram 960.1

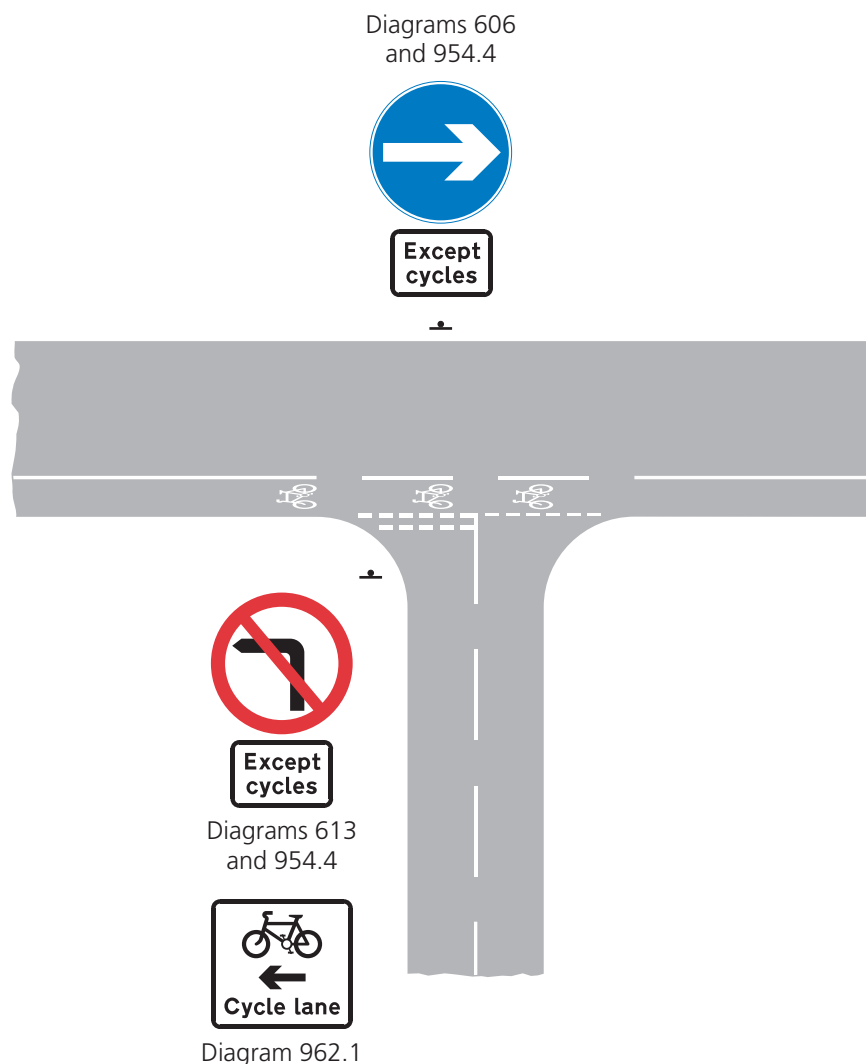

Figure 17-4 Example of the use of the sign to diagram 962.1 to indicate a mandatory contra-flow cycle lane

immediately after the junction in the major road will warn drivers of the presence of the contra-flow lane. A convenient alternative route should be provided for cyclists wanting to turn right at the junction. Where the road layout is such that traffic may turn only into the major road (e.g. the junction is not a crossroads), a sign to diagram 606, with an “Except cycles” plate as appropriate, should be provided opposite the side road as shown in figure 17-4.

17.22 Two sizes are prescribed for the sign to diagram 962.1; in most cases the smaller size will be sufficient. The sign should be mounted below any GIVE WAY or STOP sign or, if the junction is controlled by traffic signals, mounted a sufficient distance in advance of the junction so as not to obstruct the view of the signal head.

17.23 The sign shown in diagram 963.1 warns pedestrians of the presence of a cycle lane; it should not be used as a substitute for diagram 962.1 to warn drivers approaching the cycle lane from a side road. The sign is normally used for contra-flow lanes where cycles will be approaching from the opposite direction to the flow of traffic. The signs should be sited where the majority of pedestrians cross the carriageway. Where pedestrians first cross a general traffic lane, the sign, varied to LOOK LEFT with the symbols facing right, should be located on the opposite side of the road, adjacent to the cycle lane. Signs may be located on a pedestrian refuge adjacent to the cycle lane. Two sizes are prescribed for diagram 963.1. The larger size, with a 50 mm x-height, should normally be used. The smaller sign, with a 40 mm x-height, may be more suitable where



963.1 Cycle lane with traffic proceeding from right
(Sign for pedestrians)

"RIGHT" may be varied to "LEFT" and the cycle symbol reversed. "RIGHT" may be varied to "BOTH WAYS". "LANE" may be varied to "LANES" or "TRACK"

there are space constraints, such as on a pedestrian refuge. The sign may also be used for cycle tracks (see para 17.32).

ADVISORY CONTRA-FLOW CYCLE LANES

17.24 Where it is not practicable to provide a mandatory contra-flow cycle lane (prohibiting other traffic from using that part of the carriageway reserved for cycles), an advisory contra-flow lane might be considered. This is likely to occur where (a) oncoming vehicles need occasionally to encroach into the cycle lane, for example to pass parked vehicles on the opposite side or to pass cyclists travelling in the with-flow direction, (b) occasional loading and unloading needs to be allowed for within the lane, or (c) it is not possible to prohibit waiting in the lane at all times. Each of these situations will limit the benefit of the lane for cyclists, and the traffic authority will need to be satisfied that this form of provision will not unduly compromise their safety. Advisory contra-flow lanes should normally be considered only where either the 85th percentile speed of traffic is less than 25 mph, or vehicle flows are less than 1000 vehicles per day. The order required for the one-way street should permit cyclists to travel in the opposite direction without formally designating a lane for use by cycles only. The advisory lane is marked on the carriageway in a similar manner to an advisory with-flow lane, i.e. the boundary is indicated by a hazard warning line to diagram 1004. The line may be omitted where the two conditions referred above are both met, or where the road is within a 20 mph zone (see paras 14.30 to 14.32).

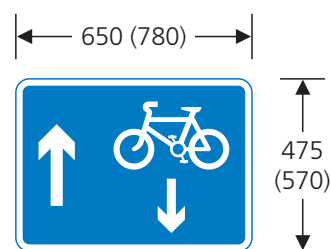

Figure 17-5 Contra-flow cycles with or without an advisory lane marked on the carriageway

This sign is not prescribed by the Regulations and requires authorisation

17.25 The one-way street signs to diagram 652 (see paras 4.35 to 4.37) are replaced by a non-prescribed variant of the sign to diagram 960.1 as shown in figure 17-5. Design details are provided on working drawing NP960.2, available from the Department on request. The drawing shows two sizes (as for diagram 960.1); the smaller size should normally be used, but the larger size might be more appropriate where no contra-flow cycle lane has been marked on the carriageway. Authorisation should be sought from the Department to use the sign (see para 2.1).

17.26 Where it is possible to provide a traffic island at the start of the contra-flow lane, signs should be the same as those shown in figure 17-3 and described in para 17.19. A "keep left" sign to diagram 610 should be provided on the island, facing oncoming traffic approaching the end of the one-way street. The island should also be protected by hatched markings as shown in figure 17-3. The continuous line denoting the edge of the cycle lane is replaced by a hazard warning line to diagram 1004. Where the lane is not marked along the whole length of the road (see para 17.24), a short length of hazard warning line, marking the boundary, should be provided at the start of the lane.

17.27 Figure 17-6 shows the start of an advisory contra-flow lane where it is not possible to provide a traffic island. This arrangement is not suitable for a mandatory contra-flow cycle lane. "No entry" signs to diagram 616 are not used because the absence of segregation would mean that they would apply to cyclists also. Direction 21(2) prohibits the use of the "Except cycles" plate with diagram 616, the main purpose of which is to protect the exit from a one-way road. "No entry" is a safety-critical sign which is very well respected. The only exception

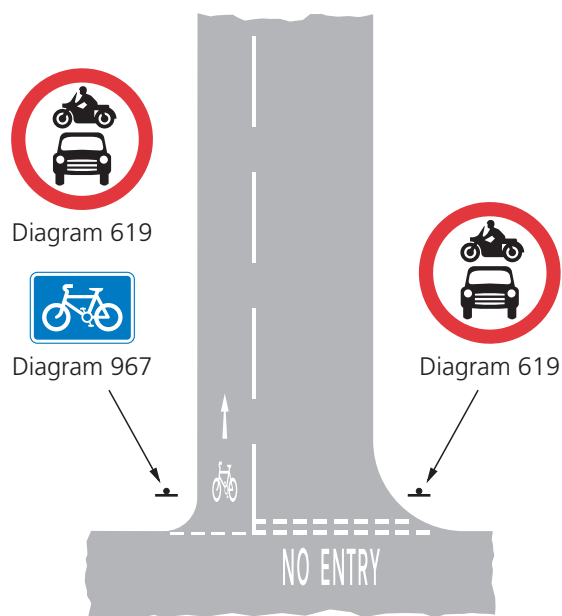

Figure 17-6 Start of an advisory contra-flow cycle lane without a traffic island

permitted is for contra-flow bus lanes; to extend this to cycles would risk undermining public respect for the sign, as to indicate that the road was not in fact one way only would invite contravention. Two “no motor vehicles” signs to diagram 619, without exception plates, are therefore used instead, as they do not prohibit pedal cycles. They should have a diameter of at least 750 mm, as drivers would be at risk if they were not seen. These signs may be supplemented by the NO ENTRY road marking to diagram 1046, in the position shown in figure 17-6; it must not encroach on the area where cyclists enter the contra-flow lane. The Directions do not prevent the NO ENTRY marking from being used on its own, i.e. it does not have to be used in conjunction with the sign to diagram 616. On the left hand side of the road, a sign to diagram 967 should be provided to indicate the cycle facility. Two sizes are prescribed; the smaller size should be adequate. The start of the contra-flow lane has a boundary line to diagram 1004 which should normally be continued for the whole length of the lane. However, where the advisory lane is not marked on the carriageway throughout its length (see para 17.24), the line to diagram 1004 should comprise at least five marks (see table 4-3 in Chapter 5). This is to ensure that vehicles emerging from the one-way street and

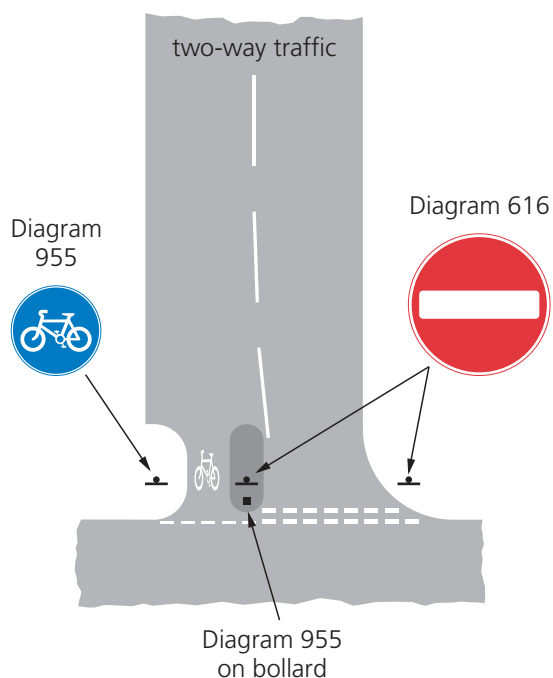

Figure 17-7 Cycle entry to a false one-way street

turning right at the junction do not encroach on that part of the carriageway used by cyclists travelling in the opposite direction.

17.28 Where a side road joins the one-way street, signs should be provided in accordance with para 17.21. The advisory contra-flow lane should be marked with a boundary line to diagram 1004 on the carriageway of the major road through the junction, together with the pedal cycle road marking to diagram 1057.

FALSE ONE-WAY STREETS

17.29 These are two-way roads with entry from one end permitted for pedal cycles only. However, motor vehicles can make a U-turn and return to where they entered the road. This allows vehicles requiring access to premises to exit the road from either end.

17.30 The entry to the street, for cycles only, is shown in figure 17-7 and is similar to the start of a mandatory contra-flow lane as described in para 17.19. A “keep left” sign to diagram 610 should be provided on the island, facing oncoming traffic approaching the end of the street.

CYCLE BY-PASSES

17.31 At road narrowings installed for the purpose of traffic calming, a gap is sometimes provided so that cyclists can by-pass the narrowing in order to avoid conflict with motor vehicles. The bollard on the island thus created should have a plain face, and not display a “keep right” arrow to diagram 610, as that would legally apply to cyclists also.

CYCLE TRACKS AND ROUTES SHARED WITH PEDESTRIANS

17.32 An off-road cycle track is indicated by the sign to diagram 955, which means that the route is for cycles only and all other vehicular traffic is prohibited. As the route is not intended for pedestrians, there should be a convenient footway or footpath nearby. The sign should be provided at the start of the cycle track and where the track crosses roads used by other traffic. The signs may also be used as repeaters along the route. The sign to diagram 967 is not appropriate for off-road cycle tracks as it is prescribed for use only on the main carriageway of a road. Where a pedestrian route crosses a cycle track the sign to diagram 963.1 may be used to alert pedestrians to the presence of cycles. The sign should be varied to CYCLE TRACK, with LOOK RIGHT varied to LOOK BOTH WAYS where the cycle track is two way.

17.33 Where a footway (forming part of a road) or footpath (e.g. through a park) has been converted to a route shared by pedestrians and cyclists, signs to either diagram 956 or 957 are used. These prohibit the use of the route by any other vehicles. The sign to diagram 956 indicates an unsegregated route. It should be located where the shared route begins and must be used as a repeater, at regular intervals (direction 11), to remind both pedestrians and cyclists that pedal cycles can be legally ridden on the footway or footpath. The sign to diagram 957 indicates a segregated shared route that should be delineated by a continuous white marking to either diagram 1049 or 1049.1 (see para 16.15 in Chapter 5). The sign may be reversed in a mirror image according to which side of the route is used by cyclists and which side by pedestrians. The sign should be located at the start of the segregated route and must be used as a repeater at regular intervals along the route (direction 11).

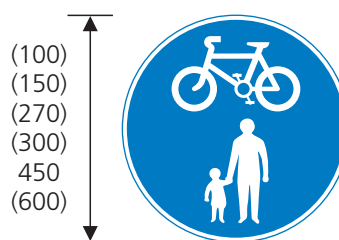

956 Unsegregated route for use by pedal cycles and pedestrians only

May be used in combination with the regional or national cycle route number plate shown in diagram 2602.3

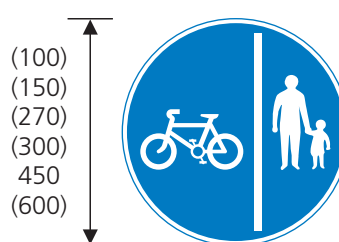

957 Segregated route for use by pedal cycles and pedestrians only

The sign is reversed in a mirror image when the route reserved for pedal cycles is on the right. May be used in combination with the regional or national cycle route number plate shown in diagram 2602.3

17.34 Several sizes are prescribed for the signs to diagrams 955, 956 and 957. As these signs prohibit motor vehicles, the 600 mm and 450 mm diameter signs should be used where they control entry from the main carriageway of a road and where motor vehicles, especially solo motor cycles, are not physically prevented from entering the cycle track or shared cycle/pedestrian route. The smaller sizes may be used as repeater signs and in bollards.

17.35 Where the cycle track or shared pedestrian route forms part of a national or regional cycle route, the supplementary plate to diagram 2602.3 may be used with the signs to diagrams 955, 956 and 957. The plate has a red background for a national route, and a blue background for a regional route. Table 17-1 shows recommended x-heights, depending on the size of sign the plate is used with.



2602.3 The number of a regional cycle route

May be used only in combination with diagram 955, 956 or 957. The background colour is varied to red when indicating the number of a national cycle route

Table 17-1 Size of plate to diagram 2602.3

Diameter of sign to diagram 955, 956 or 957 (mm)	x-height of plate to diagram 2602.3 (mm)
Less than 300	30
300	40
450	50
600	60

17.36 The end of a cycle track or shared route may be indicated by the sign to diagram 965, although this is not essential. The sign might be helpful where cyclists rejoin the main carriageway of a road at the end of a shared footway. It should not be used at an intermittent break in a cycle track or shared route, such as at a road crossing. Three sizes are prescribed for this sign. The largest size should be used where conspicuity is likely to be a problem or where a cycle route or lane ends at a hazardous location. The use of the sign to diagram 951 (see para 5.26) is not appropriate in this situation.

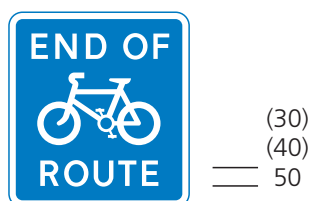

965 End of cycle lane, track or route

May be used in conjunction with diagrams 1057 and 1058

17.37 The sign to diagram 966 (CYCLISTS DISMOUNT) may be used together with the sign to diagram 965, or on its own. The sign should be provided only where cyclists are required to use a pedestrian crossing facility that they cannot legally cycle on, at the entrance to a pedestrian area, at a location with a low headroom or width restriction (e.g. a subway or bridge) or at places where visibility is restricted to such an extent that cycling would be unsafe (see also para 5.8). Two sizes are prescribed for the sign to diagram 966. The smaller size should normally be used, unless there is a particular hazard or conspicuity problem where the larger size of sign would be more appropriate. A non-prescribed variant of the sign to diagram 966, with the legend CYCLISTS REJOIN CARRIAGEWAY, may be authorised by the Department where this would be helpful at the end of a cycle track or shared footway.



966 Pedal cyclists to dismount at the end of, or at a break in, a cycle lane, track or route

18 LANE CONTROL SIGNALS AND SIGNS FOR TIDAL FLOW

LANE CONTROL SIGNALS

18.1 The signals shown in Part I of Schedule 10 to the Regulations are used on single carriageway roads where a tidal-flow system is in operation, e.g. where a high proportion of the flow is in one direction during the morning peak hours, with the major flow in the reverse direction during the evening peak. This form of control permits the higher traffic flow to use a greater width of the carriageway by reversing the traffic flow in one or more central traffic lanes at different times of the day. The “red cross” signals shown in diagrams 5003 and 5003.1 are also prescribed for use on actively-managed hard shoulders of motorways (SI 2005 No. 1670, the Traffic Signs (Amendment) Regulations and General Directions 2005), but this application is not considered here. Lane control signals may be used only to indicate the effect of an order (direction 7).

18.2 Figure 18-1 shows the basic arrangement for placing the signals above the carriageway. Regulation 44(2) requires that the height of the centre of each light signal from the surface of the carriageway in the immediate vicinity shall be not less than 5.5m nor more than 9m. Each signal is prescribed with maximum and minimum dimensions. Regulation 12(6), which requires the shape and proportions to remain the same when choosing dimensions for individual elements of a sign, does not apply in this case. This allows more flexibility when designing each signal. The overall size of each signal will depend on the speed of traffic, not just at peak times, but during free-flow conditions, as the signals are in use at all times. Although figure 18-1 shows five lanes, tidal flow can be used in other situations, such as on a three-lane carriageway.

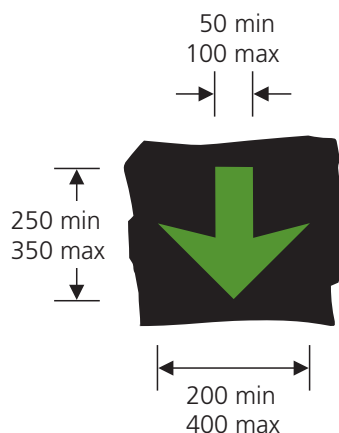

5001.1 Lane open to vehicular traffic

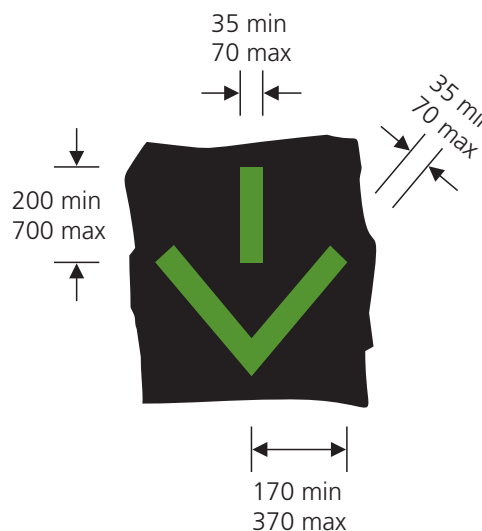

5001.2 Lane open to vehicular traffic (Alternative type)

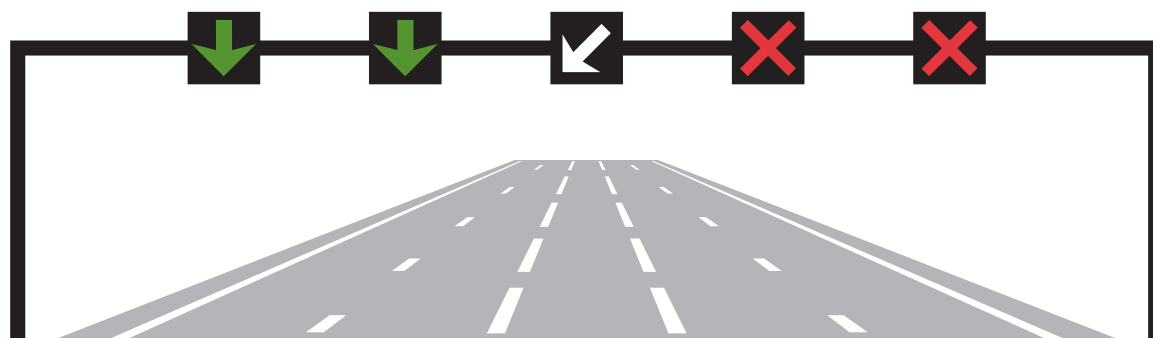

Figure 18-1 Example of lane control signals mounted above the carriageway for a tidal-flow system

18.3 A signal to diagram 5001.1 or 5001.2 is placed above a traffic lane facing the direction of oncoming vehicles to indicate that traffic in the lane below the green arrow may proceed beneath or beyond that arrow.

18.4 A signal to diagram 5003 or 5003.1 is placed above a traffic lane facing the direction of oncoming vehicles to indicate that traffic in the lane below the red cross must not proceed beneath or beyond that red cross.

18.5 A signal to diagram 5005 or 5005.1 indicates that traffic should move to the next lane to the left as soon as it is safe to do so. It is normally used at the start of a tidal-flow system to direct traffic away from

an opposing tidal-flow lane. The signal will also be needed when closing a tidal-flow lane, so that a green arrow first changes to a white arrow before changing to a red cross. However, depending on the road layout there might be situations where it is not required in one particular direction.

18.6 The signals should be mounted back to back centrally over a traffic lane to face both directions along the lane, so that whenever the green or white arrow facing traffic from one direction is showing, the red cross facing the opposite direction is also showing over the same traffic lane. When changing the direction of flow, the lane first needs to be closed with the red cross showing in both directions for a period long enough to ensure that the lane is clear

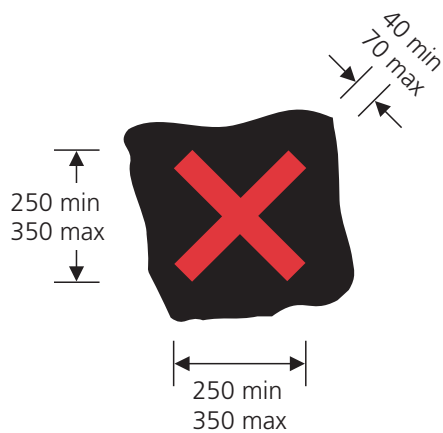

5003 Lane closed to vehicular traffic

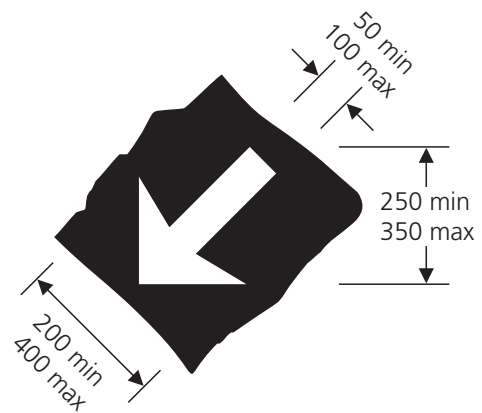

5005 Lane closed ahead and vehicular traffic should move to the next lane on the left

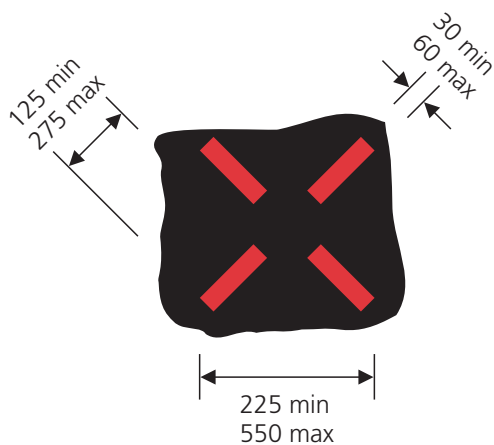

5003.1 Lane closed to vehicular traffic (Alternative type)

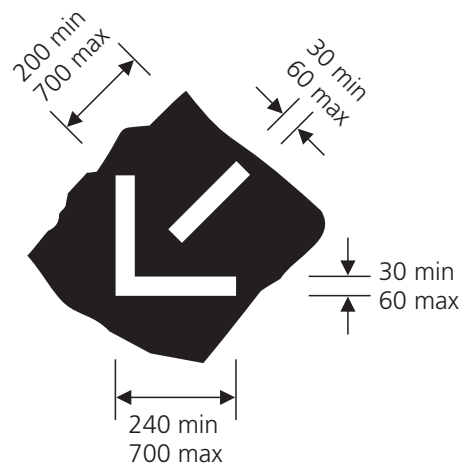

5005.1 Lane closed ahead and vehicular traffic should move to the next lane on the left (Alternative type)

of all traffic. For those lanes where the direction of flow is never changed, the green arrow and red cross, as appropriate, will be permanently displayed. These signals must be internally illuminated and identical to those displayed above the tidal-flow lane.

LANE CONTROL SIGNS

18.7 The signs shown in Part II of Schedule 10 to the Regulations are used to inform drivers of a tidal-flow system ahead and to explain the meaning of the lane control signals. The x-height of these signs may be varied from 75 mm to 150 mm and depends on the speed of traffic. Appropriate sizes are specified in Appendix A.

18.8 A sign to diagram 5010 is used on a road that leads directly into a tidal-flow system. It gives advance warning of lane control on the road ahead, and explains the meaning of the signals. The white arrow symbol and the legend "move to left" is omitted where the signal to diagram 5005 or 5005.1 is not used. The sign should be sited approximately 200 m before the first signal. A sign to diagram 5012 should be sited between 50 m and 100 m before the first signal. A sign to diagram 5014, omitting the arrow, and varied to indicate the distance to the nearest ten yards, should be sited approximately 400 m before the first signal. Where the 85th percentile speed of traffic is above 30 mph, an additional sign to diagram 5010 might be required. In this case it should be sited 400 m before the first signal, with the sign to diagram 5014 located approximately 800 m before the first signal. Where the road is one way or a dual carriageway on the approach to the tidal-flow section, a sign to diagram 5010, 5012 or 5014, as appropriate, should be provided on each side of the carriageway at each location.

18.9 The sign to diagram 5011 is similar to diagram 5010, and is used on a side road that joins a major road within a lane control section. The sign should be placed at least 50 m from the junction to enable drivers to assimilate the information on the sign before diverting their attention to the junction ahead. Where the side road is one way (with two or more lanes) or a dual carriageway, the sign should be provided on each side of the carriageway. Where a side road joins a major road prior to the start of the lane control section, a sign to diagram 5011 should be provided if drivers would not pass a sign to diagram 5010 after turning into the major road. In this case, the sign should be supplemented by a

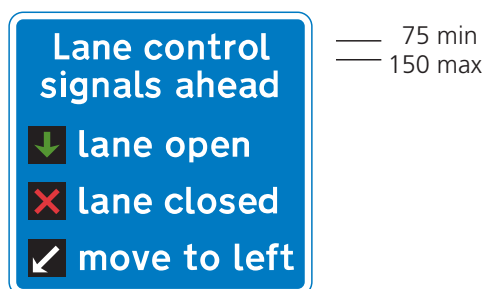

5010 Lane control light signals ahead

The white arrow symbol and the words "move to left" shall be omitted where signals to diagram 5005 or 5005.1 are not used in the lane control system

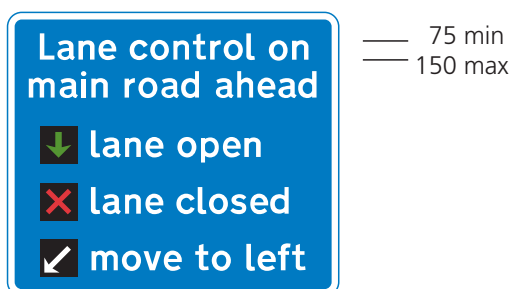

5011 Lane control light signals on a road extending from a junction ahead

The white arrow symbol and the words "move to left" shall be omitted where signals to diagram 5005 or 5005.1 are not used in the lane control system



5012 System of lane control light signals ahead

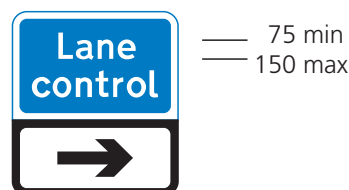

5013 Direction of a system of lane control light signals

The arrow may be reversed

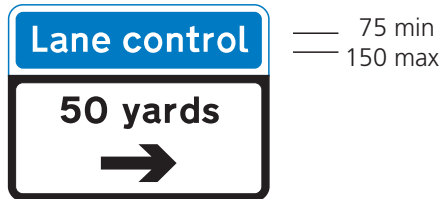
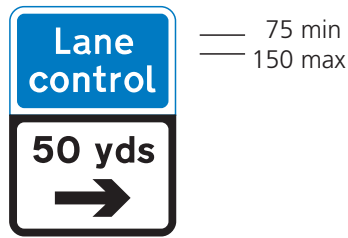

5014 Distance to and direction of a system of lane control light signals
(Alternative types)

*The distance may be varied (see Appendix B).
The arrow may be reversed or omitted*

sign to either diagram 5013 or 5014 located at the junction and with the arrow pointing in the appropriate direction. Signs to diagrams 5013 and 5014 may be used on their own where drivers, after turning into the major road, pass a sign to 5010 but not the sign to diagram 5014 without the arrow (see para 18.8).

18.10 A sign to diagram 5015 should be provided on each side of the road where the lane control signals end. Alternatively, the sign may be located above each lane that is available to traffic travelling away from the lane control section.



5015 End of a system of lane control light signals

A APPENDIX

SIZES OF SIGNS

Diagram number	Dimension	85th percentile speed of private cars (mph) (Note 1)					
		Up to 20	21 to 30	31 to 40	41 to 50	51 to 60	Over 60
570	x-height	-	62.5	62.5 (75)	75 (100)	100 (125)	125 (150)
601.1		See Table 3-2					
602		See Table 3-3					
606 (Note 5)	Diameter	450	(450) 600	(600) 750	(750) 900	(900) 1200	1200 (1500)
607	x-height	50	(50) 62.5	(62.5) 75	(75) 100	(100) 125	125
608	x-height	50	(50) 62.5	(62.5) 75	(75) 100	(100) 125	125
609	Diameter	450	(450) 600	(600) 750	(750) 900	(900) 1200	1200
610 (Note 6)	Diameter	450	(450) 600	(600) 750	(750) 900	(900) 1200	1200 (1500)
611 (Note 6)	Diameter	450	(450) 600	(600) 750	(750) 900	(900) 1200	1200
611.1 (Note 7)	Diameter	600	600 (750)	750 (900)	-	-	-
612 (Note 5)	Diameter	450	(450) 600	(600) 750	(750) 900	(900) 1200	1200
613 (Note 5)	Diameter	450	(450) 600	(600) 750	(750) 900	(900) 1200	1200
614 (Note 5)	Diameter	450	600	600 (750)	750 (900)	900 (1200)	1200
615	Diameter	600	750	(750) 900	(900) 1200	1200	-
615.1	x-height	62.5	75	(75) 100	(100) 125	125	-
616 (Note 5, 11)	Diameter	(450) 600	(600) 750	750	(750) 900	(900) 1200	1200
617	Diameter	450	(450) 600	(600) 750	(750) 900	(900) 1200	1200
618	x-height	(37.5) 50	(50) 62.5	-	-	-	-
618.1	x-height	(37.5) 50	(50) 62.5	(62.5) 75	(75) 100	100	-
618.2		One size only					
618.3		One size only					
618.3A		One size only					
618.4		One size only					
619 (Note 12)	Diameter	450	(450) 600	(600) 750	(750) 900	(900) 1200	1200
619.1	Diameter	450	(450) 600	(600) 750	(750) 900	(900) 1200	1200
619.2	Diameter	450	(450) 600	(600) 750	(750) 900	(900) 1200	1200
620 (Note 13)	x-height	(37.5) 50	(50) 62.5	(62.5) 75	(75) 100	(100) 125	125
620.1	x-height	(37.5) 50	(50) 62.5	(62.5) 75	(75) 100	(100) 125	125
622.1A	Diameter	450	(450) 600	(600) 750	(750) 900	(900) 1200	1200 (1500)
622.2	Diameter	450	(450) 600	600	750	(750) 900	900
622.4	Diameter	600	600	(600) 750	(750) 900	900	-
622.5		The size of this sign is not related to traffic speed (see Note 8)					

SIZES OF SIGNS (Cont'd)

Diagram number	Dimension	85th percentile speed of private cars (mph) (Note 1)					
		Up to 20	21 to 30	31 to 40	41 to 50	51 to 60	Over 60
622.6		The size of this sign is not related to traffic speed (see Note 8)					
622.7	Diameter	450	(450) 600	(600) 750	(750) 900	(900) 1200	-
622.8	Diameter	450	600	750	900	1200	1200
622.9	x-height	(37.5) 50	62.5	75	100	125	125
625.1		The size of this sign is not related to traffic speed (see Note 8)					
626.2A	x-height	60	(60) 80	(80) 100	(100) 120	120	-
627.1	x-height	37.5	(37.5) 50	(50) 62.5	(62.5) 75	75	-
629	Diameter	600	600	(600) 750	(750) 900	900	-
629A	Diameter	750	750	(750) 900	(900) 1200	1200	-
629.1	Diameter	600	600	(600) 750	(750) 900	900	-
629.2	Diameter	600	600	750	900	1200	1200 (1500)
629.2A	Diameter	750	750	900	1200	1500	1500
632	Diameter	-	600	600 (750)	750 (900)	900 (1200)	-
633	Diameter	450 (the larger size of 540 can be used at the discretion of the police)					
636		See para 6.27					
636.1		See working drawing P636.1					
636.2		One size only					
637.1		See para 6.33					
637.2		One size only					
637.3		See para 6.33					
638		See para 6.33					
638.1		See para 6.33					
639		See para 6.33					
639.1B		See para 7.47					
640		See para 6.33					
640.1		To suit size of parking meter cover and legend used					
640.2A		See para 6.33					
640.3		One size only					
640.4		One size only					
640.5		One size only					
642 (Terminal)	Diameter	450	600	600 (750)	750 (900)	900	900 (1200)
642 (Repeater)	Diameter	-	300	300	450	450	600

SIZES OF SIGNS (Cont'd)

Diagram number	Dimension	85th percentile speed of private cars (mph) (Note 1)					
		Up to 20	21 to 30	31 to 40	41 to 50	51 to 60	Over 60
642.2A		One size only					
642.3		See para 9.13					
645	x-height	50	62.5	75 (100)	100 (125)	125 (150)	150 (200)
646		See para 9.10					
647		One size only					
650.1		See para 9.29					
650.2		See para 6.33					
650.3		See para 6.33					
651		See para 5.30					
652	Height	450	450	450	675	675	675
660		See para 7.47					
660.3		See para 7.47					
660.4		See para 7.47					
660.5		See para 7.47					
660.6		See para 7.47					
660.7		See para 7.47					
661A		See para 7.47					
661.1		See para 7.47					
661.2A		See para 7.47					
661.3A		See para 7.47					
661.4		See para 7.47					
662		See paras 7.47 and 12.23					
663		See para 12.20					
663.1		See para 12.20					
664		See para 12.20					
665		See para 12.20					
666		See para 12.20					
667		See para 8.11 and Table 8-1					
667.1		See para 8.11 and Table 8-1					
667.2		See para 8.11 and Table 8-1					
668		See para 8.11 and Table 8-1					
668.1		See para 8.11 and Table 8-1					

SIZES OF SIGNS (Cont'd)

Diagram number	Dimension	85th percentile speed of private cars (mph) (Note 1)					
		Up to 20	21 to 30	31 to 40	41 to 50	51 to 60	Over 60
668.2		See para 8.11 and Table 8-1					
670		See Tables 14-1, 14-2 and 14-4					
671		See Tables 14-1, 14-2 and 14-4					
672		See Table 14-5					
673		See Table 14-5					
674		One size only					
675		One size only					
774	Width	900	900	900	(900) 1200	1200	-
778	Width	440	440	(440) 550	(550) 660	660	-
778.1	Width	480	480	(480) 600	(600) 720	720	-
783 (Note 9)	x-height	50	60	75	100	100	-
801		See para 7.48					
804.1		See para 7.48					
804.2		See para 7.48					
804.3		See para 7.48					
804.4		See para 7.48					
810		The size of this sign is not related to traffic speed (see Note 8)					
811	Height	600	600 (800)	800 (1000)	1000 (1200)	1200 (1600)	-
811.1	x-height	37.5	37.5 (50)	50 (62.5)	62.5 (75)	75 (100)	-
818.2 (Note 9)	x-height	60	75	100	125	150	200
818.3 (Note 9)	x-height	60	75	100	125	150	200
818.4 (Note 9)	x-height	60	75	100	125	150	200
857.1		Same size as associated sign to diagram 650.1, 650.2 or 650.3 (see Note 10)					
877		See para 15.15					
878 (Note 9)	x-height	50	60	75	100	125	150 (200)
879		See para 14.41					
880		One size only					
880.1		See para 14.45					
951		The size of this sign is not related to traffic speed (see Note 8)					
952 (Note 13)	Diameter	450	(450) 600	(600) 750	(750) 900	(900) 1200	1200
953	Diameter	(450) 600	(600) 750	750	(750) 900	-	-
953.1	Diameter	As diagram 953, but see para 16.5					

SIZES OF SIGNS (Cont'd)

Diagram number	Dimension	85th percentile speed of private cars (mph) (Note 1)					
		Up to 20	21 to 30	31 to 40	41 to 50	51 to 60	Over 60
953.2	x-height	(50) 62.5	(62.5) 75	75	(75) 100	-	-
954 (Note 11)	x-height	(37.5) 50	(50) 62.5	(62.5) 75	(75) 100	-	-
954.2 (Note 11)	x-height	(37.5) 50	(50) 62.5	(62.5) 75	(75) 100	See Note 13	See Note 13
954.3	x-height	(37.5) 50	(50) 62.5	(62.5) 75	(75) 100	-	-
954.4 (Note 14)	x-height	(37.5) 50	(50) 62.5	(62.5) 75	(75) 100	-	-
954.5		One size only					
954.6		One size only					
954.7		One size only					
955		See para 17.34					
956		See para 17.34					
957		See para 17.34					
958		See para 15.14					
958.1		See para 17.8					
959		See para 15.14					
959.1		See para 17.8					
960		See para 15.22					
960.1		See para 17.18					
961		See paras 15.14 and 17.8					
962		See paras 15.17 and 15.25					
962.1		See para 17.10					
962.2		See para 15.25					
963		See para 15.28					
963.1		See para 17.23					
963.2		See para 15.28					
963.3		See para 16.11					
964		See para 15.14					
965		See para 17.36					
966		See para 17.37					
967		See para 17.14					
968		One size only					
968.1		One size only					
969		See para 7.48					

SIZES OF SIGNS (Cont'd)

Diagram number	Dimension	85th percentile speed of private cars (mph) (Note 1)					
		Up to 20	21 to 30	31 to 40	41 to 50	51 to 60	Over 60
974		See para 9.24					
975		See para 9.24					
976		Seek advice from Her Majesty's Railway Inspectorate					
2003		See Local Transport Note 1/94					
2010.1		See Local Transport Note 1/94					
2010.2		See Local Transport Note 1/94					
2123		See Local Transport Note 1/94					
2124		See Local Transport Note 1/94					
2602.3		See Table 17-1					
2713.1		See Table 9-1					
2805		See Local Transport Note 1/94					
2806		See Local Transport Note 1/94					
2806.1		See Local Transport Note 1/94					
5010 (Note 9)	x-height	-	75	100	125	150	150
5011 (Note 9)	x-height	75	75	100	125	150	150
5012 (Note 9)	x-height	-	75	100	125	150	150
5013 (Note 9)	x-height	75	75	100	125	150	150
5014 (Note 9)	x-height	75	75	100	125	150	150
5015 (Note 9)	x-height	-	75	100	125	150	150
7032		See para 14.35					

NOTE 1: 85th percentile speed measurement is dealt with in TA 22/81 "Vehicle speed measurement on all-purpose roads" in Volume 5 of the Design Manual for Roads and Bridges (see para 1.3). The right hand column (over 60 mph) applies generally to all-purpose dual carriageway roads and, where appropriate, to motorways. It should be noted that other factors such as carriageway width and the complexity of the background against which the sign is placed may also affect sign size (see notes 2 and 3 below).

NOTE 2: The smaller bracketed sign sizes should be used only where special amenity considerations or physical constraints apply. It should be borne in mind that smaller signs are likely to be seen later, and do not become legible until drivers are closer to them, with less time to react.

NOTE 3: The larger bracketed sign sizes should be used where site conditions require increased conspicuity, such as on a wide road or where the accident record calls for greater emphasis. Conspicuity can also be increased by the use of yellow backing boards (see paras 1.31 to 1.33).

NOTE 4: The size of a sign and its corresponding supplementary plate should be taken from the same column. Where two sizes are shown for both the sign and the plate, corresponding sizes (smaller or larger) should be used.

NOTE 5: Smaller sizes, for use in bollards and alongside traffic signals, are not shown in the table.

NOTE 6: Smaller sizes, for use in bollards, are not shown in the table.

NOTE 7: This sign is normally used only where the speed limit is 30 mph or less (see para 4.22).

NOTE 8: The sizes of signs to diagrams 622.5, 622.6, 625.1, 810 and 951 are related to site conditions and not to the speed of traffic. Generally, the unbracketed size shown alongside the diagram should be used. The smaller sizes shown for diagrams 625.1 and 951 are used where the signs are mounted on, or in, bollards. The smaller size for diagrams 622.5 and 622.6 may be appropriate where amenity considerations or physical constraints apply. The larger sizes for diagrams 810 and 951 should be used where there is a need to increase conspicuity, or, in the case of diagram 810, where the sign is mounted on the opposite side of the road.

NOTE 9: These signs have a range of x-heights shown as minimum and maximum. The sizes shown in the table are those appropriate for a particular traffic speed. However, intermediate sizes may be used, especially where the traffic speed is in the middle of the range for a specific column (e.g. where the 85th percentile speed is 35 mph, the x-height of the sign to diagram 818.2 could be 110 mm). The maximum x-height of 250 mm for the sign to diagram 878 is not shown as this size is unlikely to be used, but might be considered for motorways with four or more lanes.

NOTE 10: The smallest size (20 mm x-height) is likely to be appropriate when the sign faces the footway (see para 6.16).

NOTE 11: Where the “no entry” sign to diagram 616 is used with a supplementary plate to diagram 954 or 954.2, see para 15.22. Where the “no entry” sign is used in connection with a contra-flow cycle lane, see para 17.19.

NOTE 12: Where the sign to diagram 619 is used in connection with an advisory contra-flow cycle lane, see para 17.27.

NOTE 13: Where an “Except local buses” supplementary plate is required with a 1200 mm diameter sign to diagram 952, this should be a variant of diagram 620, with an x-height of 125 mm.

NOTE 14: The table below shows the appropriate x-height of diagram 954.4 when used with the “no through road” sign to diagram 816.

Height of diagram 816 (mm)	x-height of diagram 954.4 (mm)
400	37.5
480	50
560	62.5

B APPENDIX

VARIATION OF NUMERALS AS PRESCRIBED BY SCHEDULE 16 TO THE REGULATIONS

Diagram number	Description	Item(s) in Schedule 16 (see below)
570	Distance over which restriction extends	6
615.1	Give way to oncoming vehicles (when distance is added)	6
629	Width restriction in imperial units	1
629A	Width restriction in metric and imperial units	1
629.1	Length restriction	1, 2
629.2	Height restriction in imperial units	1
629.2A	Height restriction in metric and imperial units	1
670	Maximum speed limit (see para 14.4)	1
672	Minimum speed limit	1
673	End of minimum speed limit	1
675	End of 20 mph speed limit zone (in respect of the upper panel)	1
811.1	Priority over oncoming vehicles (when distance is added)	6
818.2	Indication of a restriction ahead	6, 10
818.3	Mandatory height limit at low bridge ahead (in respect of distance)	6, 10
2713.1	Distance to parking place with emergency telephone	6, 9
5014	Distance to and direction of a system of lane control signals	6

Permitted variants in Schedule 16:

- Item 1 Numerals may be varied but (with the exception of one decimal place of a metre indicating a height, width or length) no fractions or decimal places shall be used.
- Item 2 Metric units to one decimal place of a metre may be substituted for imperial units when the sign is placed in combination with another sign shown in diagram 629.1 which has not been so varied.
- Item 6 Numerals indicating distance may be varied with –
- distances over 3 miles being expressed in miles to the nearest mile;
 - distances of $\frac{1}{2}$ mile or more but less than 3 miles being expressed to the nearest $\frac{1}{4}$ mile with the fractions $\frac{3}{4}$, $\frac{1}{2}$ and $\frac{1}{4}$ being used; and
 - distances of less than $\frac{1}{2}$ mile being expressed in yards to the nearest 10 yards; “yards” or the abbreviation “yds” may be used interchangeably.
- Where a sign includes a distance expressed in miles, the words “mile” or “miles” may be used as appropriate.
- Item 9 The indication of distance may be omitted from the sign.
- Item 10 The indication of distance may be replaced by an arrow pointing horizontally to the left or to the right as appropriate.

SCHEDULE 19 (Part I) TO THE REGULATIONS: SIGNIFICANCE OF BUS STOP AND BUS STAND CLEARWAY MARKINGS

Schedule 19 (Part I) specifies the significance of the bus stop clearway marking to diagram 1025.1, 1025.3 or 1025.4 (see paras 9.18 to 9.24). In the schedule, “clearway” refers to both a bus stop and a bus stand; “bus stop clearway” refers to a bus stop, but not to a bus stand. The following is a summary of the requirements set out in Schedule 19 (Part I); for full details refer to Schedule 19.

A vehicle shall be taken to have stopped in the clearway if –

- (a) any point within the clearway marking is below the vehicle or its load (if any); and
- (b) the vehicle is stationary.

No person driving a vehicle shall cause it to stop within a clearway during the times indicated by a sign shown in diagram 974 or 975, or, where the times are omitted from those signs, at any time. The exceptions to the prohibition of stopping are –

- (a) a bus providing a local service to –
 - (i) maintain a published timetable, but stopping for no more than 2 minutes in a bus stop clearway (no time limit for a bus stand);
 - (ii) enable passengers to board or alight; or
 - (iii) enable the crew of the bus to be changed;
- (b) a vehicle being used for fire brigade, ambulance or police purposes;
- (c) a vehicle stopping with the permission of a constable in uniform, a traffic warden or, in a special parking area designated under the Road Traffic Act 1991, a parking attendant;
- (d) a vehicle prevented from proceeding by circumstances beyond the driver's control, or to avoid injury or damage to persons or property;
- (e) a taxi to allow passengers to board or alight (including loading or unloading of luggage);
- (f) a marked vehicle being used for delivery or collection of postal packets;
- (g) a learner bus driver, to simulate the picking up and setting down of passengers; or
- (h) a vehicle being used for building purposes, removal of an obstruction, maintenance, cleaning of street furniture or utility works, provided that the vehicle cannot be used for those purposes without stopping in the clearway.

D APPENDIX

NORTHERN IRELAND VARIATIONS

The Traffic Signs Regulations and General Directions 2002 apply to England, Wales and Scotland, but in Northern Ireland the equivalent legislation is the Traffic Signs Regulations (Northern Ireland) 1997. In Northern Ireland, references to “Directions” are not applicable (see para 1.4); where these are referred to, advice should be sought from the Department for Regional Development’s Roads Service Headquarters in Belfast.

BUSES

In Northern Ireland the term “local bus” is not defined in the Traffic Signs Regulations (Northern Ireland) 1997 and should therefore not be used. The term “buses” may be varied to “permitted buses”.

CLEARWAY AND NO STOPPING SIGNS

In Northern Ireland, where diagram 1025 (NI Regulations only) is used to delineate the limits of a bus stop, an accompanying “no stopping” sign is not required. Further details can be found in Chapter 5, para 17.20.

ILLUMINATION

Different illumination requirements apply in Northern Ireland. Schedule 17 of the Northern Ireland Traffic Signs Regulations should be referred to.

TAXIS

In Northern Ireland the term “permitted taxi” is prescribed for use on traffic signs for bus lanes instead of the more general term “taxi”. Advice on the meaning of “permitted taxi” can be obtained from the Department for Regional Development’s Roads Service Headquarters in Belfast.

LEGISLATIVE VARIATIONS

The following table indicates differences in regulation numbers between the two sets of Regulations where these are relevant to this chapter of the Traffic Signs Manual. The notes below the table indicate other differences of legislation or practice between Northern Ireland and the rest of the UK.

Paragraph number in Chapter 3	Subject of regulation referred to in paragraph	Regulation in the Traffic Signs Regulations and General Directions 2002	Regulation in the Traffic Signs Regulations (Northern Ireland) 1997
2.3	Signs subject to s36 of the Road Traffic Act 1988	10	8
2.6	Reflectorisation of traffic signs	19	17
3.2	Signs subject to s36 of the Road Traffic Act 1988	10	8
3.7	Significance of a STOP sign	16	14
3.12	Significance of a GIVE WAY sign	16	14

Paragraph number in Chapter 3	Subject of regulation referred to in paragraph	Regulation in the Traffic Signs Regulations and General Directions 2002	Regulation in the Traffic Signs Regulations (Northern Ireland) 1997
4.55	Flashing blue lamp with POLICE STOP sign	54	43
5.13	Meaning conveyed by a bus symbol	24(1)	22
5.13	Definition of "local bus"	4	None
5.20	Definition of "articulated vehicle"	4	2
7.13	Style of lettering other than Transport alphabet	13(7)	11(4)
9.18	Signs subject to s36 of the Road Traffic Act 1988	10(1)	8(1)
9.18	Significance of a bus stop clearway marking	29(1)	None
11.8	Definition of "variable message sign"	58(1)	48(1)
12.1	Definition of "controlled parking zone"	4	2
13.7	Definition of "controlled parking zone"	4	2
14.2	Definition of "speed limit"	5	3
14.2 (i)	Definition of "national speed limit"	5(2)	3(2)
14.2 (ii)	Definition of "maximum speed limit"	5(1)	3(1)
14.2 (iii)	Definition of "minimum speed limit"	5(1)	3(1)
14.7	Definitions for dual carriageway roads	4	2
14.54	Illumination of signs	18	16
14.58	Reflectorisation of signs	19	17
15.11	Definition of "local bus service"	4	None
15.11	Meaning conveyed by bus and local bus symbols	24(1), 24(2)	22
16.7	Tramcars exempt from the sign to diagram 610	15(3)	13(3)
17.5	Definition of a "cycle lane"	4	2
17.12	Definition of a "cycle lane"	4	2
18.2	Mounting height of a lane control signal	44(2)	34(2)
18.2	Variation of dimensions	12(6)	10(6)

In the following notes, paragraph numbers refer to this edition of Chapter 3 of the Traffic Signs Manual.

Paragraph 1.1 In Northern Ireland, there is no direct equivalent to the Road Traffic Regulation Act 1984 or the Traffic Management Act 2004.

Paragraph 2.1 In Northern Ireland, "section 142 of the Road Traffic Regulation Act 1984 as amended by the New Roads and Street Works Act 1991" should be replaced with "article 2(2) of the Road Traffic Regulation (Northern Ireland) Order 1997".

Paragraphs 2.3 and 3.2 In Northern Ireland, "section 36 of the Road Traffic Act 1988" should be replaced with "article 50 of the Road Traffic (Northern Ireland) Order 1995".

Paragraphs 3.1, 14.47 and 16.1 In Northern Ireland, advice on the use of these signs with railways and tramways should be sought from the Department for Regional Development's Roads Service Headquarters in Belfast and from Northern Ireland Railways.

Paragraph 3.8 In Northern Ireland, "section 79 of the Highways Act 1980" should be replaced with "articles 49 and 50 of the Roads (Northern Ireland) Order 1993".

Paragraph 4.55 In Northern Ireland, "section 67 of the Road Traffic Regulation Act 1984" should be replaced with "article 32 of the Road Traffic Regulation (Northern Ireland) Order 1997". However, the seven day limit on the placing of the sign to diagram 633 does not apply in Northern Ireland.

Paragraph 5.13 In Northern Ireland, there is no equivalent to the Transport Act 1985.

Paragraph 5.28 In Northern Ireland, "Motorways Traffic (England and Wales) Regulations 1982" should be replaced with "Motorway Traffic Regulations (Northern Ireland) 1984".

Paragraph 6.21 In Northern Ireland, there is no equivalent to section 61 of the Road Traffic Regulation Act 1984.

Paragraph 9.22 In Northern Ireland, paragraph 17.20 of Traffic Signs Manual Chapter 5 should be consulted.

Paragraphs 14.1, 14.13, 14.17 and 14.28 In Northern Ireland, "section 85 of the Road Traffic Regulation Act 1984" should be replaced with "articles 41 and 43 of the Road Traffic Regulation (Northern Ireland) Order 1997".

Paragraph 14.2 In Northern Ireland, there is no equivalent to section 14 of the Road Traffic Regulation Act 1984 or Schedule 9 to the Act as amended by the Road Traffic Regulation Act (Amendment) Order 1999. In Northern Ireland, 20 mph speed limits are made under article 38 of the Road Traffic Regulation (Northern Ireland) Order 1997.

Paragraph 14.2(ii) In Northern Ireland, "sections 81 and 82 of the Road Traffic Regulation Act 1984" should be replaced with "articles 36(1) and 37 of the Road Traffic Regulation (Northern Ireland) Order 1997".

Paragraph 14.21 In Northern Ireland, "Section 82 of the Road Traffic Regulation Act 1984" should be replaced with "Article 37 of the Road Traffic Regulation (Northern Ireland) Order 1997", and "Section 81" with "Article 36(1)".

Paragraph 14.30(a) In Northern Ireland, "section 90A of the Highways Act 1980 ("the 1980 Act")" should be replaced with "article 65 of the Roads (Northern Ireland) Order 1993 ("the 1993 Order")".

Paragraph 14.30(a) In Northern Ireland, "Highways (Road Humps) Regulations 1999" should be replaced with "Road Humps Regulations (Northern Ireland) 1999".

Paragraph 14.30(b) In Northern Ireland, "section 90G of the 1980 Act" should be replaced with "article 65 of the 1993 Order".

Paragraph 14.30(b) In Northern Ireland, "Highways (Traffic Calming) Regulations 1999" should be replaced with "Traffic Calming Regulations (Northern Ireland) 1995".

Paragraph 14.30(c) In Northern Ireland, there is no direct equivalent to section 68 of the Highways Act 1980. However, for construction of new roads it may be interpreted as referring to article 3 of the Roads (Northern Ireland) Order 1993 and on existing roads to article 43 of the Roads (Northern Ireland) Order 1993.

Paragraph 14.30(d) In Northern Ireland, “section 75 of the 1980 Act” should be replaced with “article 43 of the 1993 Order”.

Paragraph 14.50 In Northern Ireland, there is no direct equivalent to the Traffic Signs (Amendment) General Directions 2004.

Paragraph 18.1 In Northern Ireland, there is no direct equivalent to SI 2005 No. 1670, the Traffic Signs (Amendment) Regulations and General Directions 2005.

DIAGRAM NUMBER VARIATIONS

In the following table, page numbers refer to this edition of Chapter 3 of the Traffic Signs Manual. The position with equivalent diagram numbers may change over time, and designers in Northern Ireland should contact the Department for Regional Development’s Roads Service Headquarters in Belfast to ascertain the current position.

Page number	Description	Diagram number in the Traffic Signs Regulations and General Directions 2002	Diagram number in the Traffic Signs Regulations (Northern Ireland) 1997
19	Route avoiding prohibited turn	2123 and 2124	None
20	Indication of restriction ahead	818.2	669
21	“Except local buses” plate	954.2	None
22	Circular exception plates	954.5, 954.6, 954.7	None
30	Lorry route advance direction sign	2805	None
30	Advance direction sign indicating a restriction	2003	None
31	Mandatory height limit at low bridge ahead	818.3	669.1
31	Mandatory height limit ahead/alternative route	818.4	None
32	Play street (supplementary plate)	618	None
37	No explosives (supplementary plate)	622.9	None
39	Weak bridge	626.2A	626.2
45 and 46	No waiting, taxis excepted part of the time	650.3	None
60	Pay at machine	661.2A	661.2
60	Pay here at machine	661.3A	661.3
62	Combined waiting restriction/parking place sign	639.1B	639.1A
62	No waiting, taxis excepted part of the time	650.3	None
78	Parking place with emergency telephone	2713.1	None
79	No stopping on entrance markings	642.2A	642.2
121	New 30 mph speed limit in force	7032	None
126	Speed camera and reminder of national limit	880.1	None
155	Number of national or regional cycle route	2602.3	None

E APPENDIX

INDEX OF DIAGRAM NUMBERS

501	1.10, 3.5	620.1	5.12
502	1.10, 3.5	622.1A	5.3, 5.15-5.19, 5.34, 5.37
503	1.10, 3.5	622.2	5.19
510	4.21	622.4	5.20
513.2	14.48	622.5	5.3, 5.21
515	4.19	622.6	5.22
522	4.5	622.7	5.3, 5.24
554.3	4.52, 5.18, 5.20, 5.41	622.8	5.3, 5.25
570	4.50, 4.53, 9.6, Appendix B	622.9	5.25
601.1	2.3, 3.1, 3.7	625.1	5.27, 5.28, 5.44
602	2.3, 3.1, 3.12, 3.13, 3.19, 4.23, 4.33	626.2A	5.3, 5.31, 5.33
606	2.3, 4.2-4.6, 4.8-4.12, 4.14, 4.16, 4.19, 4.20, 4.37, 4.38, 4.46, 11.12, Figure 16-1, 17.21	627.1	5.33
607	4.3, 4.8, 4.10, 4.15, 4.37	629	5.3, 5.34, 5.36, 5.40, 5.41, Appendix B
608	3.6, 3.13, 4.3, 4.4, 4.15, 4.24, 4.46	629A	5.3, 5.36, 5.40, 5.41, Appendix B
609	2.3, 4.2-4.6, 4.8, 4.10, 4.11, 4.14, 4.17	629.1	5.3, 5.37, 5.38, 5.40, 5.41, Appendix B
610	2.3, 4.24, 4.28, 15.23, Figure 15-13, 16.7, Figure 16-1, Figure 16-2, 17.20, 17.26, 17.30, 17.31	629.2	2.3, 5.3, 5.42, 5.43, Appendix B
611	4.27, 4.28	629.2A	2.3, 5.3, 5.42, 5.43, Appendix B
611.1	2.3, 4.20-4.22	632	4.52-4.54
612	4.2, 4.5-4.7, 4.9-4.12, 4.14, 4.18, Figure 15-4, 15.24, Figure 15-11, 17.21	633	4.55
613	4.2, 4.5-4.7, 4.9-4.12, 4.14, 4.18, 15.24, Figure 15-11, Figure 15-14, 17.21	636	6.26, 6.29
614	4.48, 4.50, 4.51	636.1	6.28, 6.29
615	2.3, 4.29, 4.31-4.33	636.2	9.33, 9.34
615.1	4.29, 4.31, Appendix B	637.1	6.10, 6.11, 6.33, 6.37, 9.5
616	2.3, 4.3, 4.7, 4.39, 4.42, 11.11, 11.12, 15.19, 15.21, 15.22, 15.29, Figure 15-13, 15.31, 16.3, Figure 16-1, Figure 17-3, 17.27, Figure 17-7	637.2	11.2, 11.14, 11.16, 11.17, 11.19
617	4.42, 5.3, 5.5-5.8, 11.5, 11.12, 11.13, 15.29	637.3	6.7, Table 6-1, 9.22, 11.14
618	5.5, 5.6	638	6.6, 6.36, 13.8
618.1	5.3, 5.5, 5.7, 5.8, 15.29, 15.32	638.1	6.6, 6.35, 6.36
618.2	5.5, 11.4, 11.6, 11.7, 11.9, 11.11, 11.18	639	6.8, Table 6-1, 6.9, 6.12, 6.14, 6.20, 6.33, 6.35, 6.36, 7.30, Table 7-4, 9.22, 11.14, 12.11
618.3	5.5, 11.4, 11.6, 11.7, 11.9, 11.11, 11.14, 11.16-11.18	639.1B	6.15, 6.25, 7.30, Table 7-4, 7.38, 7.43, 7.47, 11.14, 12.4
618.3A	5.5, 11.4, 11.6-11.9, 11.11, 11.14, 11.16-11.18	640	6.7-6.9, 6.13, 6.14, 6.17, 6.20, 6.33, 6.35, 6.36, 9.22, 11.14, 12.11
618.4	11.4, 11.13	640.1	6.30
619	4.42, 5.3, 5.9, 5.10, 5.12, 11.5, 11.6, 11.12, 15.29, 17.27	640.2A	6.18, 6.20, 12.1, 12.11, 12.17, 12.22
619.1	5.3, 5.9, 5.11, 5.12	640.3	6.21, 6.24, 6.33
619.2	5.3, 5.9, 5.11, 5.12	640.4	6.21, 6.24
620	5.12, 5.14, 5.17, 5.23-5.25, 5.39, 15.29, 15.32	640.5	6.21, 6.24
		642	6.10, 9.6, 9.7, 14.60
		642.2A	9.15, 9.16, 9.17
		642.3	9.12
		645	1.27, 4.31, 4.51, 4.53, 9.6
		646	9.9, 9.10
		647	9.9, 9.10
		650.1	6.13, 7.43, 9.25-9.28, 9.31, 9.32
		650.2	6.12-6.15, 6.17, 7.30, 7.32, 7.43
		650.3	6.12-6.15, 6.17, 7.30-7.32, 7.43
		651	5.29
		652	2.5, 4.6, 4.35-4.37, 15.20, Figure 16-1, 17.18, 17.25
		660	7.10, 7.12, 7.14, 7.15, 7.20

INDEX OF DIAGRAM NUMBERS (Cont'd)

660.3	7.10, 7.12-7.15, 7.20	818.2	4.10, 4.12, 14.19, Appendix B
660.4	6.25, 7.28, 7.29, 7.44, 8.6	818.3	1.10, 5.4, Appendix B
660.5	7.25	818.4	1.10, 5.4
660.6	7.33, 7.36, 7.38, Figure 7-5, 7.39, 7.47	857.1	6.16, 9.30
660.7	7.33, 7.36, 7.38, Figure 7-5, 7.39, 7.47	877	15.15
661A	7.17, 7.44, 8.6	878	14.40-14.42
661.1	7.8, 8.10, 12.13	879	14.40, 14.41, 14.43, 14.44, 14.46, 14.50
661.2A	7.21-7.23	880	14.40, 14.43, 14.45, 14.46, 14.63
661.3A	7.21, 7.22	880.1	14.40, 14.44, 14.45
661.4	7.21, 7.23		
662	12.5, 12.13, 12.19, 12.23	951	5.26, 17.36
663	12.1, 12.5, 12.7, 13.7	952	5.3, 5.13, 5.14
663.1	12.1, 12.5, 12.7, 12.19, 13.7	953	4.42, 15.19, 15.21, 15.22, 15.29, 15.31, Figure 15-13, Figure 15-14
664	12.12, 13.7	953.1	16.3-16.5, Figure 16-1, Figure 16-2
665	12.1, 12.15	953.2	4.42, 15.21, 15.29, 15.31, Figure 15-13, Figure 15-14, 16.3, Figure 16-1, Figure 16-2
666	12.18	954	4.14, 4.42, 5.39, 15.21, 15.24
667	8.5, 8.7, 8.8, 8.10, 8.12	954.2	4.14, 4.42, 5.14, 5.39, 15.21, 15.24
667.1	8.5, 8.7-8.10, 8.12	954.3	4.14, 4.42, 15.24, Figure 15-14
667.2	8.5, 8.7, 8.10, 8.12	954.4	4.14, 4.42, 17.21, Appendix A (Note 14)
668	8.5, 8.7, 8.8, 8.10, 8.12	954.5	4.14, 15.24, 17.21
668.1	8.5, 8.7-8.10, 8.12	954.6	4.14, 15.24
668.2	8.5, 8.7, 8.10, 8.12	954.7	4.14, 15.24
670	14.4, 14.14, 14.19, 14.23, 14.25-14.28, 14.30, 14.32, 14.41, 14.43, 14.50, 14.51, 14.54, 14.55, 14.59, 14.63, Appendix B	955	4.42, 17.19, Figure 17-7, 17.32, 17.34, 17.35
671	14.4, 14.5, 14.14-14.17, 14.19, 14.23, 14.25-14.29, 14.32, 14.41, 14.44, 14.51, 14.54, 14.55	956	17.33-17.35
672	14.37, 14.54, 14.55, Appendix B	957	17.33-17.35
673	14.37, 14.54, 14.55, Appendix B	958	15.9, Figure 15-1, 15.11, 15.12, 15.14
674	14.30, 14.31, 14.56, 14.63	958.1	17.5, 17.7, 17.8, 17.12
675	14.32, 14.56, 14.63, Appendix B	959	15.10, Figure 15-1, 15.11, 15.12, 15.14
774	3.19	959.1	17.6, 17.7, Figure 17-1, 17.8
778	3.12, 3.19	960	15.19, 15.20, 15.22
778.1	3.12, 3.19, 3.20	960.1	17.18, 17.25
779	5.43	961	15.12, 15.14, 17.7, 17.8
780A	5.43	962	15.16, 15.17, 15.24, 15.25
780.1A	5.43	962.1	17.9, 17.10, 17.15, 17.21, 17.22
780.2A	5.43	962.2	15.24, 15.25
783	3.18	963	15.26-15.28
801	7.1, 7.4-7.6, 7.8, 7.48	963.1	17.23, 17.32
804.1	7.5, Table 7-1, 7.48	963.2	15.26-15.28
804.2	7.5, Table 7-1, 7.48	963.3	16.10, 16.11
804.3	7.5, Table 7-1, 7.48	964	15.13, 15.14, 15.21
804.4	7.1, 7.5, Table 7-1, 7.48	965	17.11, 17.16, 17.20, 17.36, 17.37
810	4.38	966	5.8, 17.37
811	4.30, 4.31	967	17.13, 17.14, 17.27, 17.32
811.1	4.30, 4.31, Appendix B	968	7.7
816	Appendix A (Note 14)	968.1	7.7
		969	7.5, Table 7-1, 7.8, 7.48

INDEX OF DIAGRAM NUMBERS (Cont'd)

970	9.21	1044	4.34
974	2.3, 9.19-9.21, 9.23, Appendix C	1046	4.41, 4.47, 5.6, 17.27
975	2.3, 9.19-9.21, 9.23, Appendix C	1048	15.14, 15.19
976	14.49, 16.1	1048.1	15.19
		1048.3	15.19, 15.32
1002.1	3.7, 3.15	1048.4	15.19, 15.32
1003	3.12, 3.15, 4.23, 4.33	1049	15.10, 15.19, 15.30, 17.5, 17.11, 17.17, 17.33
1003.3	4.20, 4.23		
1003.4	4.20	1049.1	17.33
1004	14.64, 17.12, 17.16, 17.24, 17.26-17.28	1050	15.15
1004.1	14.64, 17.12, 17.16	1057	17.11, 17.13, 17.16, 17.28
1005	14.64	1058	17.11, 17.16
1005.1	14.64	1065	14.63
1008	14.64	2003	5.3
1008.1	14.64	2010.1	4.7
1009	17.5, 17.12	2010.2	4.7
1010	4.4, 15.9	2024	4.21
1017	6.8, Table 6-1, 6.9, 6.14, 7.32, 8.9, 9.17, 9.22, 11.14, 12.1, 12.17, 17.3	2119	4.21
1018.1	6.6-6.8, 6.14, 8.9, 9.12, 9.17, 9.22, 11.14, 12.1, 15.5	2120	4.21
1019	6.6-6.9, 6.14, 6.36, Table 7-4, 9.22, 11.16, 12.1	2123	4.7
1020.1	6.6-6.8, 6.14, 6.36, 9.12, 9.22, 11.16, 12.1	2124	4.7
1022	3.15	2402.1	14.50, 14.51, 14.60
1023	3.15, 4.23, 4.33	2403.1	14.51
1025.1	2.3, 9.18, Appendix C	2501	7.4
1025.3	2.3, 9.18, Appendix C	2602.3	17.35
1025.4	2.3, 9.18, Appendix C	2713.1	9.14, Appendix B
1026.1	7.52, 12.10	2805	5.2
1027.1	9.15	2806	5.2
1028.2	6.14, 6.17, 7.32, 7.43, 9.25, 9.27, 9.31	2806.1	5.2
1028.3	6.25, 7.1, Table 7-1, 7.9, 7.10, 7.18, 7.20, 7.29, 7.32, 7.44, 8.6	2901	5.28, 14.27, 14.28
1028.4	7.1, 7.6, 7.9, Table 7-3, 7.20, 7.22, 7.25, 7.26, Table 7-4, 7.39, 8.6, 8.9, 8.10, Figure 8-1, 12.23	2931	14.28
1029	4.38	5001.1	18.3
1032	6.25, 7.1, Table 7-1, 7.9, Table 7-3, 7.18, 7.22, 7.25, 7.29, Table 7-4, 7.39, 7.44, 7.50, 12.23	5001.2	18.3
1033	6.25, 7.1, 7.6, 7.9, Table 7-3, 7.18, 7.22, 7.25, 7.29, Table 7-4, 7.39, 7.44, 7.50, 12.23	5003	18.1, 18.4
1036.1	4.5, 4.8, 4.10, 4.12	5003.1	18.1, 18.4
1036.2	4.7, 4.9, 4.12	5005	18.5
1037.1	4.5, 4.8, 4.10, 4.12	5005.1	18.5
1038	4.10, 4.12, 4.35	5010	18.8
1043	4.34	5011	18.9
		5012	18.8
		5013	18.9
		5014	18.8, 18.9, Appendix B
		5015	18.10
		7009	14.48
		7032	14.33, 14.34
		7275	14.48
		7290	14.47
		7294	14.48

INDEX

Advance warning signs	1.10, 1.12
“Ahead only” signs	4.9, 4.12
Alternative route signs	5.2, 5.4
Ambulances	6.17, 9.15, 9.31
Backing boards	1.21, 1.31-1.33, 14.50-14.53
Bollards	4.19, 4.28, 4.43, 15.21
plain-faced	4.13, 4.25, 4.27, 17.31
Boundary signs	14.51, 14.60
Bridges	
height restrictions	5.42, 5.43
priority signs	4.31
weight restrictions	5.31-5.33
Bus lanes	15.1-15.3, 15.5-15.28
see also the following:	
contra-flow bus lanes	4.42
illumination of signs	2.6
one-way streets	4.42
tramways	16.9
Buses (other facilities)	15.4, 15.29-15.32
see also the following:	
bus stand markings	9.20, Appendix C
bus stop clearways	9.18-9.24, 10.8, 15.7, Appendix C
bus stop markings	9.18-9.23, 10.8, Appendix C
in controlled parking zones	12.1, 12.15-12.18, 12.23
length restrictions	5.37-5.41
parking signs	7.5, Table 7-1, Table 7-2, 7.48
in pedestrian zones	11.2, Table 11-1
prohibition signs	5.3, 5.13, 5.14
waiting restrictions	6.18-6.20, 9.20, 12.1, 12.15-12.18
weight restrictions	5.31
width restrictions	5.34, 5.39
Camera signs	14.39-14.46, 14.50
Caravans	
parking signs	7.5, Table 7-1
Clearways	9.1-9.24
see also the following:	
bus stop clearways	10.8, 15.7, Appendix C
red route clearways	10.9
Compulsory turns	4.2-4.5, 4.8, 4.12, 4.16, 4.17

Controlled parking zones (CPZs)	Section 12
<i>see also the following:</i>	
disc zones	Table 7-4
parking places	7.2, 7.6, Table 7-4
voucher parking	7.24-7.26, Table 7-4
Culs-de-sac	5.10, 7.15, 7.42, 12.10, 14.9, 14.30
Cycle by-passes	17.31
Cycle lanes	17.1-17.28
Cycle tracks	17.32-17.37
<i>see also the following:</i>	
mounting signs	1.21, 14.62
Cycles (other provisions)	
in bus lanes	15.1, 15.2, 15.15, 15.20, 15.21, 15.24, 15.26
bus-only streets	15.29
by-passes	17.31
false one-way streets	17.29, 17.30
in one-way streets	4.42
parking signs	7.7
in pedestrian zones	11.5
prohibition signs	5.5, 5.26
“Cyclists dismount” signs	5.8, 17.37
Directional signs	1.12, 5.2, 5.3, 15.30, 16.8
Disabled badge holders	
all vehicles prohibited	5.7
in controlled parking zones	12.5, 12.6
parking	7.16-7.20, 7.27, 7.30, Table 7-4, 7.44, 7.51, 10.3, 10.9
pedestrian zones	11.2, Table 11-1, 11.16
waiting restrictions	6.3
Distance plates	4.31, 4.50, 4.53, 4.54, 5.3, 9.6, 9.7
“Dual carriageway” plates	3.6, 3.13, 4.3, 4.24
Emergency lay-bys	9.12-9.14, Table 9-1
End of restriction signs	
bus lanes	15.13
clearways	9.6, 9.9
controlled parking zones	12.12, 12.18
cycle lanes	17.11
cycle tracks	17.36, 17.37
goods vehicles prohibitions	5.19
lane control systems	18.10
pedestrian zones	11.13
restricted parking zones	13.7
20 mph zones	14.32

“End” plates	1.27, 1.28, 4.31, 4.51, 9.6
Entrance markings	9.15, 9.16
Exception plates	4.14, 4.15
buses	4.14, 4.42, 5.14, 5.39, 15.21, 15.24, 15.29
cycles	4.14, 4.42, 17.21
“except for access”	5.7, 5.10, 5.12, 5.14, 5.17, 5.23-5.25, 5.39, Table 11-1
“except for loading”	5.7, 5.12, 5.17, 5.39
height restrictions	5.43
length restrictions	5.39, 5.40
width restrictions	5.39, 5.40
Fluorescence	1.32, 14.52
Footways	
mounting signs	1.21, 7.49
parking	Section 8
shared with cycles	17.33-17.37
waiting restrictions	6.10, 6.11, 6.37, 8.1, 8.4, 8.9
“GIVE WAY” signs	3.4, 3.12-3.14
<i>see also the following:</i>	
advance warning signs	1.10, 3.5
dual carriageways	3.6
junctions	3.4
mounting	1.26
railway level crossings	3.1, 3.19
regulations	3.2
road markings	3.15, 3.16, 4.33
roundabouts	3.17, 4.23
shape	1.7
siting	3.16, 3.17
size	3.14, Table 3-3
tramway crossings	3.1, 3.19, 3.20, 16.2
“Give way to oncoming vehicles” plates	4.29, 4.31, Appendix B
Goods vehicles	
alternative route signs	5.2, 5.4
controlled parking zones	12.1, 12.15-12.18
“except for loading by”	5.12
loading bays	7.27-7.29, Table 7-4
parking signs	7.5, Table 7-1
in pedestrian zones	Table 11-1
waiting restrictions	6.18-6.20, 12.15-12.18
weight restrictions	5.3, 5.15-5.19, 5.31-5.33, 12.16
Height limit restrictions	5.2-5.4, 5.42, 5.43, Appendix B
High-occupancy vehicle lanes	15.1
Horses, prohibition signs	5.22, 5.23

“Ice” plates	4.52, 5.18, 5.20, 5.41
Illumination	1.30, 2.5-2.7, 4.36, 14.52, 14.54-14.58
“Keep left” signs	4.24, 4.25, 4.28, 16.7, 17.20, 17.26, 17.30
“Keep right” signs	4.26, 4.28, 16.7, 17.31
Lane control signals and signs	Section 18
Large or slow vehicles	
road markings for parking places	7.10, Table 7-3, Table 7-4
signs for level crossings	3.18
Legal issues	
application of regulations	1.1, 2.1
illumination of signs	2.5-2.7
traffic regulation orders	2.2-2.4, 3.2
Length limit restrictions	5.2-5.4, 5.34, 5.37-5.41, Appendix B
Loading bays	6.25, 7.27-7.30, Table 7-4, 7.32, 7.53, 13.3
Loading restrictions	6.1-6.8, Table 6-2, 6.28, 6.31-6.36, 7.30, Table 7-4, 7.32
<i>see also the following:</i>	
bus stop clearways	9.21, 9.22
bus lanes	15.6
controlled parking zones	12.3, 12.7, 12.22
cycle lanes, mandatory	17.4
goods vehicles	5.19
pedestrian zones	11.2, 11.16, 11.18, 11.19
red routes	10.2, 10.3, 10.6, 10.7
restricted parking zones	13.2-13.5, 13.8
road markings	6.36, 7.32
taxi ranks	6.13, 6.14, 9.27
urban clearways	9.9, 9.11
London	6.11, 8.1
Long, low vehicles	3.18
Lorry route signs	5.2
Motor cycles	
in bus lanes	15.1
parking signs	7.5, 7.6, Table 7-1, 7.8, Table 7-2
Motorways	
red cross signals	18.1
sign visibility	1.17
speed limit signs	Table 14-1, Table 14-4, 14.27-14.29
Mounting signs (general)	1.21-1.33
<i>see also individual sections</i>	

- “No entry” signs 4.3, 4.7, 4.8, 4.10, 4.39-4.47
see also the following:
 bus gates 15.29, 15.31
 contra-flow bus lanes 15.21, 15.22
 contra-flow cycle lanes 17.19, 17.27
 size of signs 15.22, 17.19, Appendix A
- “No left turn” signs
 bus lanes 15.24
 cycle lanes 17.21
 junctions 4.2, 4.5-4.7, 4.9-4.14, 4.18
- “No motor vehicles” signs 4.42, 5.3, 11.5, 11.6, 15.29, 17.27
- “No overtaking” signs 4.52-4.54
- “No right turn” signs
 bus lanes 15.24
 cycle lanes 17.21
 junctions 4.2, 4.5-4.7, 4.9-4.12, 4.14, 4.18
- “No stopping” signs 9.1, 9.2
 24-hour rural clearways 9.3-9.8
 bus stop clearways 9.18-9.24, Appendix C
 on entrance markings 9.15-9.17
 emergency lay-bys 9.12-9.14
 on taxi ranks 6.12, 6.13, 9.25-9.32
 temporary prohibition 9.33, 9.34
 urban clearways 9.9-9.11
 on verge or footway 6.10
- “No U-turns” signs 4.48-4.51
- “No vehicles” signs 4.42, 5.3, 5.5, 5.7, 5.8, 11.5, 11.6, 15.29
- Northern Ireland 1.4, 7.16, Appendix D
- Off-highway loading areas 6.21-6.25
- “One way” plates 4.3, 4.5, 4.8, 4.10
- One-way roads/streets 4.35-4.43
 buses 15.20, 15.29, 15.31
 cycle lanes 17.2, 17.17-17.21, 17.24-17.28
 “one-way traffic” signs 2.5
 pedestrian zones 11.11
 traffic islands 4.27, 4.28
 tramways 16.6
- “One way” signs (for pedestrians) 4.38
- “One-way traffic” signs 2.5, 4.35-4.37
- “Only” plates 15.21, 15.29, 15.31, 16.3
-

Parking	Section 7
<i>see also the following:</i>	
co-locating signs	12.11, 12.17
controlled zones	12.4
disabled badge holders	10.3, 12.5, 12.6
disc zones	12.4, 12.5, 12.23
on footways	Section 8
limited waiting	8.10, 12.13
pay and display	8.10, 12.5, 12.13
pedestrian zones	11.2
permit parking	8.10, 12.5, 12.6, 12.9, 12.10, 12.13
red routes	10.2, 10.3, 10.6, 10.7
repeater signs	8.8-8.10, 8.12, 8.13
restricted zones	Section 13
siting signs	8.12-8.14
size of signs	8.11, Table 8-1
sporting venues	12.14
taxis	6.12-6.16
on verges	8.1-8.14, 9.5
voucher parking	12.2, 12.5, 12.6, 12.19
Parking meters	6.30, 7.1, 12.5
“Pass either side” signs	4.27, 4.28
Pedestrians	
bus lane signs	15.26-15.28
cycle lane signs	17.23
cycle tracks	17.23, 17.32-17.35, 17.37
“look left/right/both ways” signs	15.26-15.28, 16.10, 17.23, 17.32
“one way” signs	4.38
pedestrian refuges	4.24, 15.27, 15.28, 17.23
prohibition signs	5.27, 5.28, 5.44
road markings	4.38
tramways	16.6, 16.10, 16.11
Pedestrian zones	Section 11
Play streets	5.5, 5.6
Police	4.55, 6.17, 6.26, 6.27, 9.15, 9.31
Priority signs	4.29-4.34, Appendix B
Prohibited turns	4.5-4.7, 4.9-4.14, 4.18
Prohibition signs	1.7, 4.1, 5.1-5.44, 6.1-6.37, 9.1-9.34
Railway level crossings	3.1, 3.7, 3.12, 3.18, 3.19
Red routes	Section 10
Reflectorisation	1.30, 2.5-2.7, 14.52, 14.54-14.58

Refuges	4.24, 4.25, 4.27, 15.21, 15.27, 15.28, 17.23
Repeater signs	
24-hour rural clearways	9.6
cycle lanes	17.6, 17.13, 17.18
cycle tracks	17.32-17.34
“no overtaking”	4.54
“no U-turns”	4.50
“one-way traffic” signs	4.37
parking places	7.50, 8.8-8.10
restricted parking zones	13.4, 13.8
speed limit signs	14.21-14.24, Table 14-4
dual carriageways	14.25
minimum speed limits	14.36-14.38, Table 14-5, Table 14-7
motorways	14.27-14.29
mounting	1.26, 14.61
traffic on mown verges prohibitions	5.30
waiting or loading restrictions	6.19, 6.24, 6.37
Restricted parking zones	Section 13
Road surface treatment	13.1, 13.6, 13.9
Road and street works	1.13, 2.5, 3.15, 4.20, 4.24, 4.26, 4.28, 4.52, 6.29, 7.53, 9.33, Table 14-1, Table 14-2, 14.47, 14.48
Roundabouts	
“GIVE WAY” signs	3.13, 3.17, 4.23
“keep left” signs	4.25
mini-roundabouts	3.13, 4.20-4.23
road markings	4.20, 4.23
siting signs	4.21
size of signs	4.22
speed limit signs	14.18, Table 14-2, 14.28
“turn left” signs	4.19
Siting signs	1.15-1.20
<i>see also individual sections</i>	
Size of signs	1.14, Appendix A
<i>see also individual sections</i>	
“Snowdrifts” plates	5.18, 5.41
Speed camera signs	14.39-14.46, 14.50
Speed limits	Section 14
<i>see also the following:</i>	
mounting signs	1.26, 1.28
repeater signs	1.26
siting	1.19
terminal signs	1.26, 1.31
variation of numerals	Appendix B

Sporting venues	7.15, 7.41, 12.14
“STOP” signs	3.1-3.11
<i>see also the following:</i>	
advance warning signs	1.10
mounting	1.26
railway level crossings	3.18
road markings	3.15, 3.16
siting	3.16, 3.17
size	3.11, Table 3–2
tramway crossings	3.20, 3.21, 16.2
Stopping prohibitions	Section 9
<i>see also the following:</i>	
bus stop clearways	Appendix C
red routes	Section 10
siting signs	1.20
Supplementary plates (general)	1.8, 1.21, 1.22, 1.25, 1.27, 1.28
Taxis	
bus lanes	15.2, 15.15, 15.26
bus-only streets	15.29
pedestrian zones	Table 11-1, 11.18
red routes	10.2, 10.8, 10.9
tram gates	16.4
Taxi ranks	6.12-6.17, 9.25-9.32, 7.30-7.32, Table 7-4, 7.43
Temporary waiting/loading prohibitions	6.26-6.30
Tidal-flow systems	Section 18
Traffic calming schemes	4.26, 14.30
Trams and tramways	Section 16
<i>see also the following:</i>	
speed limit signs	14.49
tramway crossings	3.1, 3.7, 3.8, 3.12, 3.19-3.21
“Turn left” signs	4.2-4.6, 4.10-4.12, 4.14, 4.16, 4.17, 4.19
“Turn right” signs	4.2, 4.3, 4.5, 4.6, 4.10-4.12, 4.14, 4.16, 4.17
Vehicle prohibitions	Section 5
<i>see also the following:</i>	
all vehicles	4.42, 11.5, 11.6, 15.29
motor vehicles	4.42, 11.5, 11.6, 15.29, 17.27
Verges	
parking	8.1- 8.14, 9.5
prohibition of traffic	5.29, 5.30, 5.44, 9.3, 9.5, 10.2, 10.9
waiting restrictions	6.10, 6.11, 6.37, 8.1, 8.4, 8.9, 9.5

Visibility of signs	1.15-1.18
minimum visibility distance	1.15-1.17, Table 1-1, Table 14-3, Table 14-4, Table 14-6, 14.46
mounting signs	1.21, 1.29, 1.30
siting signs	1.15-1.18, 1.21
speed camera signs	14.46
speed limit signs	14.19, Table 14-3, Table 14-4, Table 14-6, 14.46, 14.62
Voucher parking	7.24-7.26, 7.30, Table 7-4, 12.2, 12.5, 12.6, 12.19
Waiting restrictions	Section 6
<i>see also the following:</i>	
at any time	7.31, 9.22
bus stop clearways	9.21, 9.22
bus lanes	15.5
buses and goods vehicles	12.1, 12.15-12.18
co-locating signs	8.9, 12.17
controlled parking zones	Section 12
cycle lanes, mandatory	17.3, 17.4
parking and loading bays	7.28, 7.30-7.32
pedestrian zones	11.2, 11.4, 11.7, 11.8, 11.14, 11.15, 11.17-11.19
red routes	10.2
restricted parking zones	13.2, 13.9, 13.10
taxi ranks	7.30, Table 7-4, 7.32, 7.43, 9.25-9.29
urban clearways	9.9, 9.11
verges or footways	8.1, 8.4, 8.9, 9.5
Weight limit restrictions	5.2- 5.4, 5.15-5.19, 5.31-5.33
overnight parking	12.15-12.18
Width limit restrictions	5.2-5.4, 5.34-5.36, 5.39-5.41, Appendix B
Working drawings	1.8, 1.9, 5.7, 6.5, 6.31, 7.3, 7.45, 8.5, 11.7, 12.19
<i>see also the following:</i>	
bus lane signs	15.11, 15.12
CPZ entry signs	12.13
cycle lane signs	17.7
disc zone signs	12.19
emergency lay-by signs	9.14
entrance markings signs	9.15
non-prescribed signs	7.15, 13.5, 13.7, 13.8, 14.42, 15.1, 17.25
parking/loading bay signs	7.13, 7.19, 7.21, 7.22, 7.26, 7.28
priority signs	4.31
speed limit signs	14.32, 14.59
temporary waiting restriction signs	6.27, 6.28
tram and bus only signs	16.4
vehicle prohibition signs	5.29, 5.38

Regulatory Signs explains the correct use of regulatory signs prescribed by the Traffic Signs Regulations. These include prohibited turns, waiting and loading restrictions and bus and cycle lanes. There is also a comprehensive section dealing with the signing of speed limits.

ISBN 978 0 11 552925 2



www.tso.co.uk

ISBN 978-0-11-552925-2

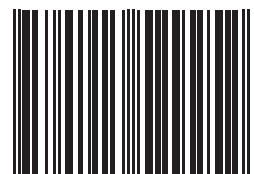

9 780115 529252 >